

G U R P S<sup>®</sup>

# STEAMPUNK

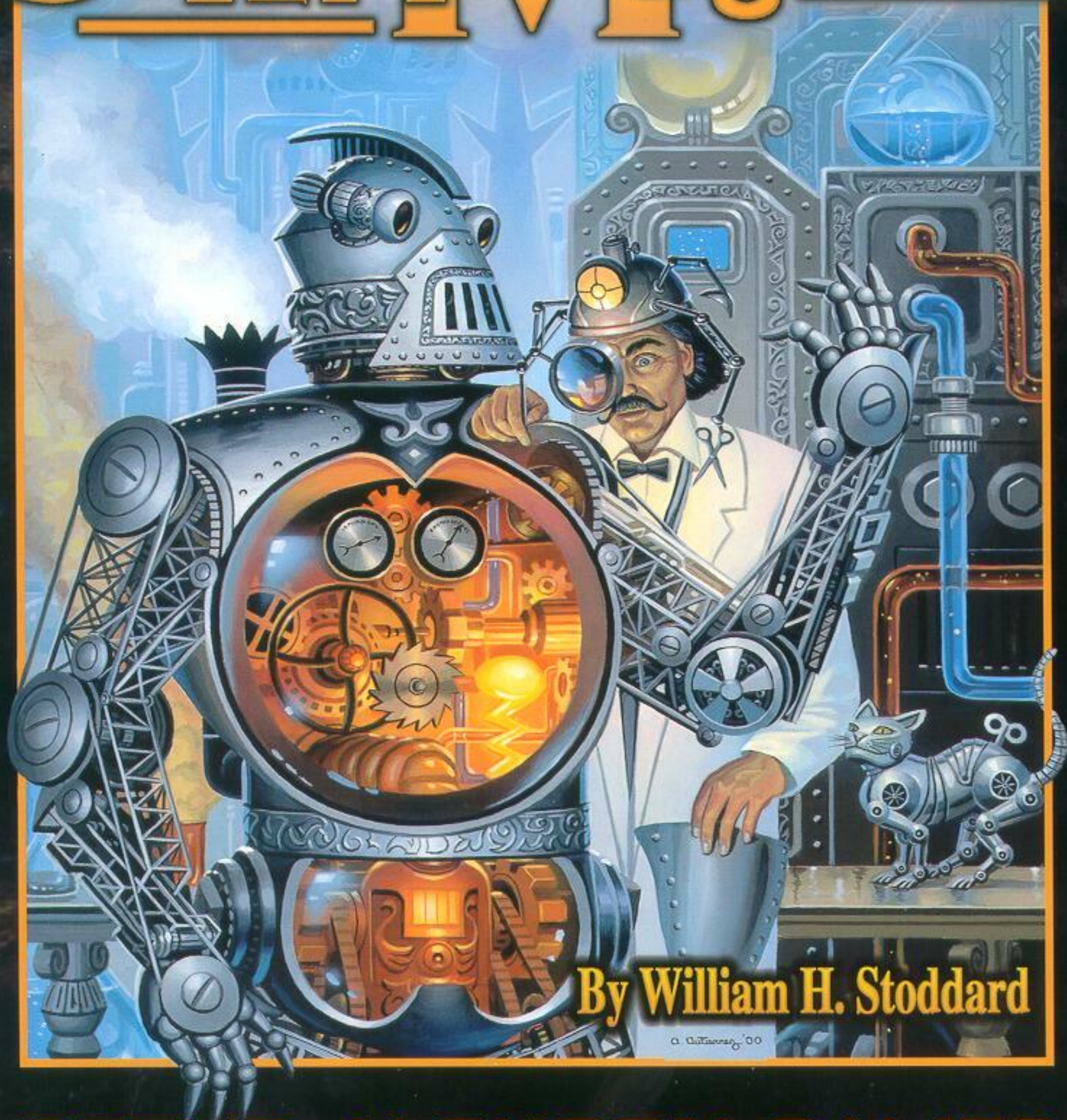

By William H. Stoddard

© Chitrago '00

STEVE JACKSON GAMES



G U R P S

# STEAMPUNK

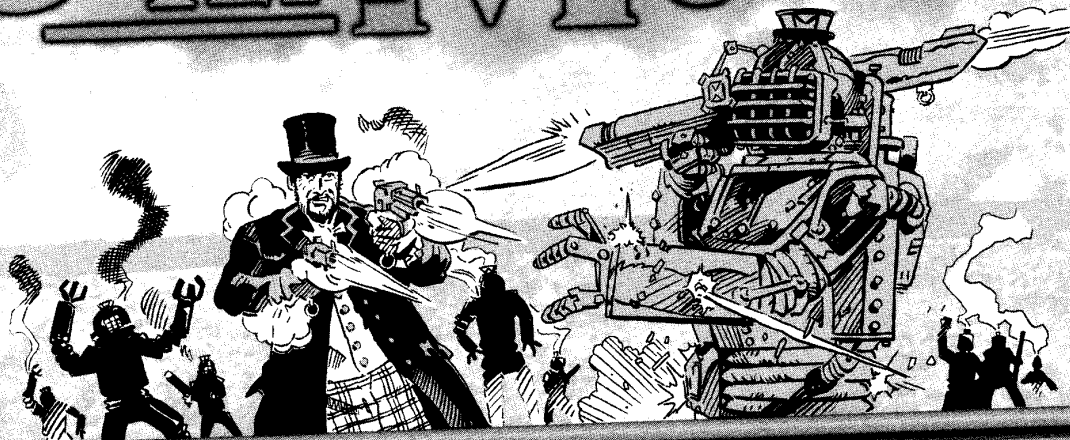

Written by William H. Stoddard  
Edited by Alain H. Dawson

Additional material by Alain H. Dawson,  
Steve Jackson, M.A. Lloyd,  
David Morgan-Mar, and Sean Punch  
Additional editing by Sean Punch  
and Gene Seabolt

Cover art by Alan Gutierrez  
Cover design by Alex Fernandez  
Design, typography,  
and layout by Alex Fernandez  
Illustrated by Paul Daly,  
David Day, and Zach Howard

Additional illustrations by  
Tom Biondolillo, Storn Cook,  
C. Brent Ferguson, Andrew Kilian,  
David Lynch, Sean Murray,  
Philip Reed, and Kieren Yanner

*GURPS* System Design by Steve Jackson  
Managing Editor ◊ Alain H. Dawson  
Line Editor ◊ Sean Punch  
Production Manager ◊ Russell Godwin  
Art Director ◊ Philip Reed  
Print Buyer ◊ Shawn Havranek

*GURPS* Errata  
Coordinator ◊ Andy Vetromile  
Lead Playtester ◊ Peter Dell'Orto  
Sales Manager ◊ Ross Jepson

*Playtesters:* Mark Baker, Glenn Barnett, Frederick Brackin, Jim Cambias, Mark Cogan, John M. Ford, Richard Gadsden, Joanna Hart, Kenneth Hite, Bob Huss, J. Hunter Johnson, Jonathan Lang, Berislav Lopac, Phil Masters, Stephen Miller, Nana Yaw Ofori, Sean Punch, Tracy Ratcliff, T. Carter Ross, Brian C. Smithson, Chad Underkoffler, William Wenz, Michael Wilson, Shawn Wilson, and Sleepless in the Saddle (Laura Kate Barrett, Marc Biagi, James H. Hay, Carol Kalescky, Jonathan Kuo, Allison Lonsdale, and Janet Tait)

*GURPS* and the all-seeing pyramid are registered trademarks of Steve Jackson Games Incorporated. *Pyramid* and the names of all products published by Steve Jackson Games Incorporated are registered trademarks or trademarks of Steve Jackson Games Incorporated, or used under license. *GURPS Steampunk* is copyright © 2000 by Steve Jackson Games Incorporated. All rights reserved. Some art copyright www.arttoday.com.

ISBN 1-55634-419-8

1 2 3 4 5 6 7 8 9 10

# STEVE JACKSON GAMES

# CONTENTS

## INTRODUCTION ..... 4

## 1. THE STEAMPUNK GENRE ..... 5

SCIENCE AND TECHNOLOGY ..... 6	Alternative Technology ..... 6	<i>Charles Babbage</i> ..... 6	<i>Ada Byron</i> ..... 7	Weird Science ..... 8	<i>Other Eminent Victorians</i> ..... 8	TL(5+1), or "What the heck is the tech level?" ..... 9	OTHER PLACES AND TIMES ..... 10	OTHER AGES OF STEAM ..... 11	SOCIETY, CULTURE, AND "PUNK" ..... 12	<i>Incorporating Magic?</i> ..... 12	<i>Other Variant TLs</i> ..... 13
--------------------------------	--------------------------------	--------------------------------	--------------------------	-----------------------	---	--	---------------------------------	------------------------------	---------------------------------------	--------------------------------------	-----------------------------------

## 2. THE SPIRIT OF THE AGE ..... 14

SCIENCE, INVENTION, AND INDUSTRY ..... 15	<i>Timeline, 1815-1914</i> ..... 15	What If? ..... 16	GEOGRAPHY AND EXPLORATION ..... 17	What If? ..... 18	WARFARE ..... 18	Land Warfare ..... 18	What If? ..... 19	Naval Warfare ..... 19	What If? ..... 20	Aerial Warfare ..... 21
---	-------------------------------------	-------------------	------------------------------------	-------------------	------------------	-----------------------	-------------------	------------------------	-------------------	-------------------------

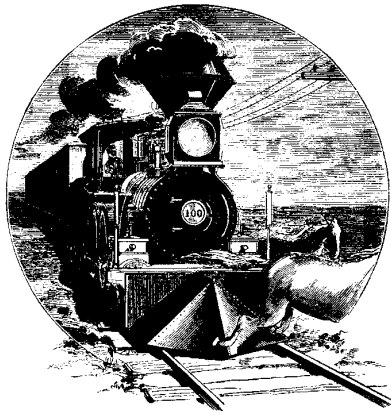

ORGANIZATIONS ..... 21	What If? ..... 22	POLITICS ..... 23	Representative Government ..... 24	What If? ..... 25	<i>The Depth of the Past</i> ..... 25	<i>Primitive Man</i> ..... 25
------------------------	-------------------	-------------------	------------------------------------	-------------------	---------------------------------------	-------------------------------

SOCIAL CLASSES AND DAILY LIFE ..... 26	<i>Victorian Safety Net</i> ..... 26	What If? ..... 27	THE WORLD OF IDEAS ..... 27	<i>Separate Spheres</i> ..... 27	<i>The Scandalous Victorians</i> ..... 27	What If? ..... 28	LOOKING FORWARD ..... 29
--	--------------------------------------	-------------------	-----------------------------	----------------------------------	---	-------------------	--------------------------

## 3. CHARACTERS ..... 30

CHARACTER CONCEPTS ..... 31	Aesthete ..... 31	Army or Navy Officer ..... 32	Captain of Industry ..... 32	Clergyman ..... 33	Creation ..... 33	Demimondaine ..... 34	Detective ..... 34	Engineer ..... 35	Explorer ..... 35	Inventor ..... 36	Medium ..... 37	Native Leader ..... 38	Reckoner ..... 38	Reformer ..... 39	Reporter ..... 39	Scientist ..... 40	Servant ..... 41	Sportsman ..... 42	SOCIAL POSITION ..... 43	Women as Adventurers ..... 43	ADVANTAGES, DISADVANTAGES, AND SKILLS ..... 44	Advantages ..... 44	New Advantages ..... 44	Disadvantages ..... 45	New Disadvantages ..... 45	TL5 Skills ..... 46	TL(5+1) Skills ..... 47	New Skills ..... 48	ECONOMICS, JOBS, AND WEALTH ..... 48	Currency and Prices ..... 48	Social Status and Cost of Living ..... 49	Job Table ..... 50	USING CHARACTERS FROM HISTORY AND FICTION ..... 50	Captain Nemo ..... 51
-----------------------------	-------------------	-------------------------------	------------------------------	--------------------	-------------------	-----------------------	--------------------	-------------------	-------------------	-------------------	-----------------	------------------------	-------------------	-------------------	-------------------	--------------------	------------------	--------------------	--------------------------	-------------------------------	--	---------------------	-------------------------	------------------------	----------------------------	---------------------	-------------------------	---------------------	--------------------------------------	------------------------------	---	--------------------	--	-----------------------

## 4. MATTERS OF LIFE AND DEATH ..... 52

THE DUEL ..... 53	CIVILIZED WARFARE ..... 53	<i>Martial Arts</i> ..... 53	<i>The Playing Fields of Eton</i> ..... 53	On the Front Line ..... 54	<i>Scientific Fisticuffs</i> ..... 54	Mechanized Warfare ..... 55
-------------------	----------------------------	------------------------------	--	----------------------------	---------------------------------------	-----------------------------

Aerial Combat ..... 55	<i>Military Organization and Rank</i> ..... 55	COLONIAL WARFARE ..... 56	NAVAL COMBAT ..... 56	The Age of Sail ..... 56	<i>Purchased Commissions</i> ..... 56	<i>Rail Transport and Logistics</i> ..... 56	<i>Communication</i> ..... 57	The Age of Steam ..... 58	<i>Field Intelligence</i> ..... 58	<i>The General Staff</i> ..... 58	The Dreadnought Age ..... 59	<i>Naval Organization and Rank</i> ..... 59	THE GREAT GAME ..... 60	CRIMINAL INVESTIGATION ..... 61	<i>Codes and Cryptography</i> ..... 61	<i>Bertillon Statistics</i> ..... 62	<i>Punishment</i> ..... 62	HEALING AND MEDICINE ..... 63	<i>Drugs</i> ..... 64	<i>Nursing</i> ..... 65	<i>Medicine and Mortality Rates</i> ..... 65	INVENTING THE PAST ..... 66
------------------------	--	---------------------------	-----------------------	--------------------------	---------------------------------------	--	-------------------------------	---------------------------	------------------------------------	-----------------------------------	------------------------------	---	-------------------------	---------------------------------	--	--------------------------------------	----------------------------	-------------------------------	-----------------------	-------------------------	--	-----------------------------

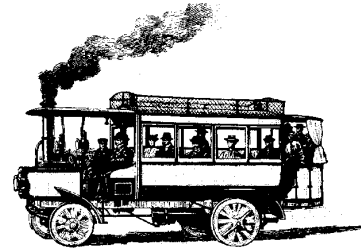

## 5. MARVELOUS INVENTIONS ..... 67

THE INVENTOR ..... 68	NEW MATERIALS ..... 68	THE SKYSCRAPER ..... 68	PRIME MOVERS ..... 69	Water Power ..... 69	Wind Power ..... 69	Clockwork ..... 69	Steam Engines ..... 69	Primary Batteries ..... 71	Power Transmission ..... 71	How Much Power Do We Need? ..... 72	VEHICLES ..... 72	Land Vehicles ..... 73	Simple Steampunk Vehicles Design ..... 73
-----------------------	------------------------	-------------------------	-----------------------	----------------------	---------------------	--------------------	------------------------	----------------------------	-----------------------------	-------------------------------------	-------------------	------------------------	---



Vehicle Stats Key ..... 73	Water Vehicles ..... 78	Air Vehicles ..... 80	Space and Time Vehicles ..... 83	ANALYTICAL ENGINES AND AUTOMATA ..... 85	Examples of Analytical Engines and Automata ..... 86
----------------------------	-------------------------	-----------------------	----------------------------------	--	--

MECHANICAL MEN	86
WEAPONS	87
PERSONAL EQUIPMENT	90
Optics	90
Tools	90
Other Devices	90
Clothing and Armor	90
THE CHEMIST'S SHOP	91
TL5 Drugs	91
TL(5+1) Drugs	92
Chemical Substances	93

## 6. WEIRD SCIENCE . . . . . 94

THE LUMINIFEROUS ETHER	95
Properties of the Ether	95
<i>New Elements</i>	95
<i>Mysterious Rays</i>	95
Wireless Telegraphy	96
Reactionless Drives	96
<i>What Makes the Sun Shine?</i>	96
Ethereic Shock	97
<i>Habitable Planets</i>	97
<i>Sunken Continents</i>	97
<i>Elan Vital</i>	98
ANTIGRAVITY	99
Gravity Screens	99
Negative Mass	100
THE SECRET OF LIFE	100
Making Men from Animals	100



<i>Alternative Theories of Evolution</i>	100
Making Men from Corpses	102
Making Men from Chemicals	103
PSYCHICAL RESEARCH	103
Psychic Powers	103
Ghosts	104
<i>Eugenics</i>	104
<i>Humanity Transformed</i>	104
Ethereic Devices and the Spirit World	105
Psychic Archaeology	106
<i>Predictive Social Science</i>	106
MAGIC	107
Fairy Tale Magic	107
Victorian Ritual Magic	107
<i>Phrenology</i>	107
Industrial Magic	108
<i>Transcendentalism</i>	108

## 7. THE GRAND TOUR . . . . . 109

TRAVEL AND ITS DIFFICULTIES	110
<i>As Powerful as a Locomotive</i>	110
<i>Circumnavigation</i>	110
THE BRITISH EMPIRE	111
<i>A Man, A Plan, A Canal – Panama!</i>	111
<i>Free Trade</i>	111

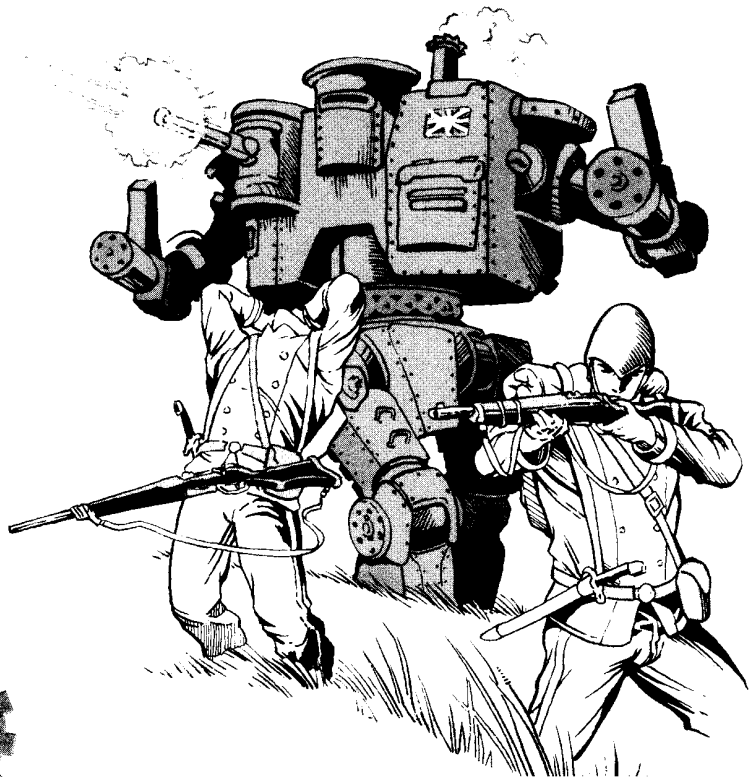

<i>Colonialism and Its Discontents</i>	112
The Metropolis	113
<i>The Irish Question</i>	113
<i>Abolishing Slavery</i>	113
OUR AMERICAN COUSINS	114
<i>Latin America</i>	114
THE CONTINENT	116
<i>The Wild West</i>	116
ASIATIC KINGDOMS	117
<i>The Balkans</i>	117
<i>Virtual Europe</i>	118
Japan	119
Zionism	119
<i>Mecca</i>	119
<i>Japonaiserie</i>	119
THE DARK CONTINENT	120
<i>The South Seas</i>	120
Missionaries	120
THE PLANETS	121
Mercury	121
Venus	121
<i>The Boers</i>	121
<i>Leopold's Crime</i>	121
Mars	122
<i>Places of Mystery</i>	122
Jupiter	123

Saturn	123
<i>The Planet Vulcan</i>	123

## 8. STEAMPUNK CAMPAIGNS . . . . . 124

BUILDING THE CAMPAIGN	125
<i>Cross-Genre Campaigns</i>	125
WORLDS OF WONDER	126

Etheria	126
<i>Being Etherian</i>	128
<i>Etheria's World of the Mind</i>	128
<i>Venereans</i>	129
Iron	130
<i>Martians</i>	131
<i>Being Ironic</i>	131
<i>Iron's World of the Mind</i>	132
<i>The Pinkertons</i>	132
<i>Steel Soldiers</i>	133
<i>John Bauer</i>	133
Qabala	134
<i>Being Qabalistic</i>	134
<i>Qabalah's World of the Mind</i>	135
<i>Rabbinical Enchantments</i>	135
<i>Rebekah Schwartzberg</i>	137
Providence	138
<i>Being Providential</i>	138
<i>Providence's World of the Mind</i>	139
<i>Nine Worthies</i>	140
<i>Father Carlos Javier</i>	141

## GLOSSARY . . . . . 142

## BIBLIOGRAPHY . . . . . 143

## INDEX . . . . . 144



## ABOUT GURPS

Steve Jackson Games is committed to full support of the *GURPS* system. Our address is SJ Games, Box 18957, Austin, TX 78760. Please include a self-addressed, stamped envelope (SASE) any time you write us! Resources now available include:

*Pyramid* ([www.sjgames.com/pyramid](http://www.sjgames.com/pyramid)). Our online magazine includes new rules and articles for *GURPS*. It also covers the hobby's top games – *Dungeons & Dragons*, *Traveller*, *World of Darkness*, *Call of Cthulhu*, *Shadowrun*, and many more – and other Steve Jackson Games releases like *In Nomine*, *INWO*, *Car Wars*, *Toon*, *Ogre*, and more. And *Pyramid* subscribers also have access to playtest files online, to see (and comment on) new books before they're released.

*New supplements and adventures.* *GURPS* continues to grow, and we'll be happy to let you know what's new. A current catalog is available for an SASE. Or check out our Web site (below).

*Errata.* Everyone makes mistakes, including us – but we do our best to fix our errors. Up-to-date errata sheets for all *GURPS* releases, including this book, are always available from SJ Games: be sure to include an SASE with your request. Or download them from the Web – see below.

*Q&A.* We do our best to answer any game question accompanied by an SASE.

*Gamer input.* We value your comments. We will consider them, not only for new products, but also when we update this book on later printings!

*Internet.* Visit us on the World Wide Web at [www.sjgames.com](http://www.sjgames.com) for an online catalog, errata, updates, and hundreds of pages of information. We also have conferences on CompuServe and AOL. *GURPS* has its own Usenet group, too: [rec.games.frp.gurps](mailto:rec.games.frp.gurps).

*GURPSnet.* Much of the online discussion of *GURPS* happens on this e-mail list. To join, send mail to [majordomo@io.com](mailto:majordomo@io.com) with "subscribe GURPSnet-L" in the body, or point your World Wide Web browser to [gurpsnet.sjgames.com/](http://gurpsnet.sjgames.com/).

The *GURPS Steampunk* Web page is at [www.sjgames.com/gurps/books/steampunk](http://www.sjgames.com/gurps/books/steampunk).

### PAGE REFERENCES

See *GURPS Compendium I*, p. 181, or <http://www.sjgames.com/gurps/abbrevs.html> for a full list of abbreviations for *GURPS* titles. Any page reference that starts with B refers to *GURPS Basic Set, Third Edition, Revised*; e.g., p. B144 refers to page 144 of *Basic Set*. AE refers to *Alternate Earths*. AET refers to *Alternate Earths 2*. BIO refers to *Bio-Tech*. CI refers to *Compendium I*. CII refers to *Compendium II*. D refers to *Dinosaurs*. H refers to *Horror*. HT refers to *High Tech*. M refers to *Magic*. ME refers to *Mecha*. P refers to *Psionics*. SW refers to *Swashbucklers*. T refers to *Technomancer*. TT refers to *Time Travel*. UN refers to *Undead*. VE refers to *Vehicles*. WWi refers to *Who's Who I*, and WWii refers to *Who's Who 2*.

# INTRODUCTION

Behold the power of Steam!

*GURPS Steampunk* is your guide to the 19th-century imagination. The real 19th century was an age of amazing inventions and discoveries – but these accomplishments inspired visions of even greater achievements. Jules Verne's fictional odysseys and H.G. Wells' scientific romances took contemporary readers on a journey into the realms of possibility. At the same time, inventors such as Charles Babbage and Nikola Tesla proposed new technologies as radical as those in fiction, from steam-powered mechanical computers to wireless electric power. All of these men looked ahead to a future transformed by science and engineering.

At the end of the 20th century, their visions have a renewed fascination. In some ways, the Age of Steam is very familiar. In our time, as in theirs, technology is making radical leaps forward and forcing society to change along with it. But the political and cultural differences make it exotic. Steampunk's vitality as a genre comes from this mix of familiarity and strangeness, and from our sense of wonder at the past that might have been.

*GURPS Steampunk* is a genre book, a collection of tools for running steampunk campaigns. Within its pages you'll find the history, geography, and culture of both the real 19th century and alternative Ages of Steam. There are templates for character archetypes from the clergyman to the demimondaine, from the native leader to the scientist. For those interested in machinery, there is a collection of wonderful devices based on 19th-century science and engineering, plus a chapter devoted to weird science. The final chapter outlines campaign worlds that can provide settings for your steampunk campaign – or inspiration for you to create your own settings.

And so, ladies and gentlemen, welcome to the future past . . .

## ABOUT THE AUTHOR

William H. Stoddard is a developmental editor for a large scientific publisher, where his job responsibilities include researching obscure questions. This is also one of his favorite recreations and helped out a lot in his work on *GURPS Steampunk*, as well as his previous work for Steve Jackson Games: contributions to *GURPS Vehicles Companion*, *GURPS Villains*, and both volumes of *GURPS Who's Who*. He has been playing roleplaying games since 1975, when he discovered *Dungeons and Dragons* at his first science fiction convention. He shares an apartment in San Diego with his cohabitant, Carol Kalescky, two cats, two computers, and a large number of books. In his spare time he edits the Libertarian Futurist Society's quarterly newsletter, *Prometheus*. For relaxation he cooks, reads, rents movies, or roleplays.

## INTRODUCTION





# CHAPTER 1 THE STEAMPUNK GENRE

*Lord, Thou has made this world below the shadow of a dream, An', taught  
by time, I tak' it so – exceptin' always Steam.*

*– Rudyard Kipling, "McAndrew's Hymn"*



## CHARLES BABBAGE 125 POINTS

Born 1792; died 1871.  
Age 42; 5'9"; 150 lbs.; dark hair, conservatively dressed.

ST 10 [0]; DX 10 [0]; IQ 14 [45]; HT 9 [-10]  
Speed 4.75; Move 4.

**Advantages:** Filthy Rich [50]; Gadgeteer [25]; Manual Dexterity +1 [3]; Mathematical Ability [10]; Reputation (Excellent host, among upper classes, +1) [3]; Status 2 [5]; Versatile [5].

**Disadvantages:** Compulsive Behavior (Perfectionist) [-5]; Curious [-5]; Obsession (Building his analytical engine) [-10]; Reputation (Impractical reform schemes, among businessmen and politicians, -1) [-3]; Sense of Duty (His sons) [-5].

**Quirks:** Befriends mechanics and collects machinery [-1]; Believes in miracles [-1]; Entertains frequently [-1]; Seeks government funding for his analytical engine at awkward social moments [-1]; Whig, free trader, antisocialist [-1].

**Skills:** Administration-12 [1/2]; Carousing-9 [2]; Cryptology-16 [2]; Economics-14 [4]; Engineer/TL5 (Mechanical)-15 [4]; Mathematics-17 [4]; Mechanic/TL5-12 [1/2]; Politics-12 [1/2]; Research-13 [1]; Riding-9 [1]; Savoir-Faire-16 [0]; Theology-11 [1/2]; Writing-12 [1/2].

**Languages:** English-14 [0]; French-12 [1/2]; Italian-12 [1/2]; Latin-12 [1/2].

Charles Babbage is best remembered for designing the analytical engine, a steam-powered mechanical computer. Trained in mathematics at Cambridge, in 1812 he instigated an Analytical Society to introduce continental mathematics to England, and from 1828 to 1839 he served as Lucasian Professor of Mathematics at Cambridge. Dissatisfied with errors in published mathematical tables, he imagined machines that would calculate and typeset such tables automatically. His work on his difference and analytical engines sharpened his interest in technology and manufacturing and encouraged his belief in the economic importance of industry, an uncommon view then. He found time to invent limelight for theaters, plan general-purpose machine tools, write numerous books, reform the Royal Society, run for Parliament, and become a popular host in London.

This is Babbage in 1833, just after his first meeting with Ada Byron (p. 7). His skill in Mathematics and Cryptology is raised by Mathematical Ability, but his Engineering skill is not, though it is enhanced by his Versatility. He likes to show off his partially constructed difference engine and the Silver Lady, a dancing clockwork automaton which he first saw as a boy and recently bought.

*Miss Harriet Cooper had been intrigued when she received the invitation to view Mr. Babbage's new Analytical Engine. She had a very modern passion for natural science, and had made some small contributions to that field, so that a mutual acquaintance had thought to introduce her to Mr. Babbage as a fellow student of the sciences. Though the Engine was outside her normal sphere of interest, Miss Cooper was flattered to be included in the tour.*

*That is, until she had entered the cavernous room containing the Engine and had seen it for herself.*

*She looked up at the huge machine, clacking away, smelling the hard smells of oil, steel, and copper. It was thinking, but with no mind. It was as though the elements of the earth had come together to judge mankind for his insolence. It was terrifying and inexorable; she could see that there was no going back to the way things were, even if the Luddites smashed the thing tomorrow.*

*Suddenly overwhelmed by an unreasoning vision, she backed away, unnoticed by the other guests. "This will be the death of us all," she whispered, but her faint words were crushed by the Engine's overwhelming din.*

Welcome to the world of steampunk – a place that can be more dystopian than 1984, or more hopeful than *Utopia*. Steampunk might be factory girls scuttling from the path of roaring steamcars as they cut through the soot choked streets of London. Luddites destroying the machines that threaten their jobs. Spies seeking out the latest military breakthroughs in flying warships. Or it might be marvels such as clockwork prosthetics, flying cities, and space travel. Supercomputers driven by steam turbines. Expeditions into the past or future. It might even be a world where mentalists and spirit mediums contact Things that Man Was Not Meant to Know.

It all centers around the question "What if?" as applied to the vibrant and complex Age of Steam. What if the 19th-century boom in science and technology went faster and farther? What if electrical power was never harnessed? What if the British Empire had to fight the French for territory on Venus? **GURPS Steampunk** encompasses all these possibilities, and countless others. Steampunk is the Age of Steam that might have been.



## SCIENCE AND TECHNOLOGY

The inspiration for a retrotech world can come from a variety of sources. Some inventions were within the reach of the science and technology of the past, but were not developed for some reason. Others come from the predictions and speculations of past scientists and seemed possible in their time, but are now understood to be impossible. Still others were the visions of authors of "scientific romances" such as Verne and Wells; some were even known to be impossible in their own time.

A campaign based on such sources can take one of two basic options: alternative technology or weird science.

## ALTERNATIVE TECHNOLOGY

An *alternative technology* campaign has the same natural laws as the real world, but exploits them in different ways.





### **Advanced Technology**

A simple way to achieve an alternative technology is to allow an invention to be developed early. Babbage's design for an analytical engine was perfectly workable; the problem was funding its construction. *The Difference Engine* assumes that funds were provided and builds its alternative history on that premise. Other technologies could have been developed earlier than they were; for example, natural philosophers and medical students experimented with ether and laughing gas decades before anyone used them for surgical anesthesia.

### **Retarded or Absent Technology**

A less obvious way to produce a steampunk world is to delay or remove some key invention. For example, James Clerk Maxwell's electromagnetic equations first predicted the existence of radio waves. Heinrich Hertz demonstrated such waves experimentally in 1888, leading to the development of radio and electronics. If Maxwell had never worked out his equations, the development of electronics might have been delayed, leading to a steampunk 20th century that relied on mechanical devices.

### **Divergent Technology**

Many versions of alternative technology pursue a more complex approach, in which some technologies are advanced and others are retarded. This usually works best if the changes have some common theme or concept. For example, a steampunk world might combine advanced mechanical computation with retarded electronics. For another example – though hardly steampunk – many science fiction writers have portrayed worlds where the biological sciences advanced faster than the physical sciences. This approach might be thought of as “technology in a different key.”

## **ADA BYRON**

**75 POINTS**

Born 1815; died 1852.  
Age 18: 5'6"; 130 lbs.; dark hair, dressed in the style of an artist.

**ST** 9 [-10]; **DX** 10 [0]; **IQ** 12 [20]; **HT** 11 [10]  
Speed 5.25; Move 5.

**Advantages:** Attractive [5]; Charisma +1 [5]; Fashion Sense [5]; Hair [5]; Mathematical Ability [10]; Musical Ability +1 [1]; Status 5 [20]; Strong Will +1 [4]; Wealthy [20].

**Disadvantages:** Impulsiveness [-10]; Overconfidence [-10]; Social Stigma (Woman) [-5].

**Quirks:** Passionate temperament [-1]; Fascinated by Babbage [-1]; Interested in science [-1]; Loves to ride [-1]; Obedient to her mother [-1].

**Skills:** Mathematics-12 [1]; Musical Instrument [Piano]-11 [1]; Musical Notation-12 [1]; Needlecraft-9 [1]; Riding-11 [4]; Savoir-Faire-14 [0]; Writing-11 [1].

**Languages:** English-12 [0]; French-10 [1/2]; Italian-10 [1/2].

Augusta Ada Byron (later the Countess of Lovelace) was Lord Byron's only legitimate child. She was raised by his estranged wife, who had her taught mathematics and music, hoping she would grow up without her father's passionate nature. Ironically, her daughter became passionate about a mathematical idea – Babbage's analytical engine. In 1843, she translated an Italian article on it, adding appendices longer than the original article to set forth new concepts such as the computer program – though it occasioned a brief quarrel with Babbage when he corrected her proofs without informing her! Her later life was difficult, wed to a dull husband whom her mother easily dominated. Ada drank and took opium, but was worst afflicted by compulsive gambling, and had an affair with John Crosse, one of her race-track friends. She died of uterine cancer, nursed by her mother, who took advantage of her weakness to cut her off from all her friends, including Babbage.

As a young woman, Byron has limited skills, but people react well to her; she has +1 to reaction rolls from Attractiveness, +1 from Charisma, and +1 from Fashion Sense, and often additional bonuses from status. Most men condescend to her, though, as they do to women in general, giving -1 to reaction rolls from Social Stigma.



## OTHER EMINENT VICTORIANS

### PHINEAS T. BARNUM (1810-1891)

The 19th century's greatest showman, famed for saying, "There's a sucker born every minute." His exhibits included the original Siamese twins, Chang and Eng, and General Tom Thumb, a midget 25 inches tall.

### CLARA BARTON (1821-1912)

Trained as a nurse, she served in the American Civil War and the Franco-Prussian War, founded the American Red Cross in 1881, and secured U.S. government approval of the International Red Cross.

### OTTO VON BISMARCK (1815-1898)

The Prussian aristocrat who created a unified Germany; possibly the most brilliant diplomat and strategist of his century, as well as the most ruthless, an attitude exemplified by his slogan "iron and blood."

### HELENA PETROVNA BLAVATSKY (1831-1891)

Founder of Theosophy, an influential school of occultism including doctrines about astral dimensions and the lost race of Atlantis, which Blavatsky said was revealed to her by ancient ascended spiritual masters during her travels in Tibet.

### NELLIE BLY (1867-1922)

The pen name of Elizabeth Cochrane, a star reporter for the *New York World*. In 1889-1890, she traveled around the world in 72 days, emulating Jules Verne's fictional hero Phileas Fogg.

### ISAMBARD KINGDOM BRUNEL (1806-1859)

Chief engineer for the Great Western Railway; after its completion he turned to building steamships, including the *Great Western* (1838), one of the first transatlantic steamships, and the *Great Eastern* (1858), a 27,824-ton supership that was used to lay telegraph cables after proving too large for commercial use.

### RICHARD BURTON (1821-1890)

A brilliant linguist and one of the greatest explorers of his time, though some of his interests would have scandalized his contemporaries. See pp. WWi108-109.

### LORD BYRON (1788-1824)

The fact that he was Augusta Ada Byron's father makes him a natural pivot for historical divergences. See pp. WWi98-99.

### SAMUEL COLT (1814-1862)

Best summarized by the 19th-century epigram about his revolver: "God made men, but Colonel Colt made them equal."

*Continued on next page . . .*

## Secret Alternative Technology

Alternative technology could be developed in secret, while the rest of the world continues along our normal timeline. This requires an explanation of why the discoverers of the technology wanted to keep it secret, how they hid it, and why they didn't give it away simply by using it. Some technologies are harder to hide than others; weapons technologies, for example, are normally used in public with highly visible effects. However, informational technologies are easier to conceal, and sometimes secrecy enhances their usefulness – as in the case of cryptography – so this form of steampunk can be made plausible as secretly advanced alternative technology.

## WEIRD SCIENCE

A *weird science* campaign has different natural laws that make outlandish technologies possible.

### New Science

The simplest way to develop a campaign with different laws of nature is to assume that the current ones are correct, but that there are additional laws, forces, or processes not yet discovered. The difficult part is coming up with new discoveries that might plausibly be made with 19th-century apparatus. One possibility would be magnetic monopoles surviving from the very early evolution of the universe; physicists such as Michael Faraday could have recognized them and grasped some of their significance.

### Different Science

A more drastic solution is to assume that the setting of a steampunk campaign has at least one different natural law. In a sense, the standard system of *GURPS* tech levels makes this assumption: reactionless drives and faster-than-light travel are impossible according to current theoretical physics, and force fields are at least questionable. A steampunk campaign where one of these was discovered earlier would fit this description.

### Disproved Science

Perhaps a more interesting variant on this formula is to assume that some scientific theory of the 19th century, later proven false, had proven instead to be true. One obvious candidate is the existence of a luminiferous ether (see p. 95). Various disproven biological theories, such as inheritance of acquired characteristics or vitalism (see sidebar, pp. 100-103), could also be worth exploring. For a wilder variant, assume the truth of a theory discarded before 1815, such as the phlogiston theory of combustion that was rejected with the discovery of oxygen.

### Impossible Inventions

A campaign based on 19th-century scientific romances may need to assume changes in natural law to allow the inventions or discoveries they describe. For example, H.G. Wells knew perfectly well that the giant insects of *The Food of the Gods* violated the square-cube law; real giant wasps would have been unable to walk, let alone fly! Stories featuring new elements with extraordinary properties require a different Periodic Table or changes in nuclear physics. In a cinematic campaign, such problems can be handwaved away; but it may be interesting to admit them, come up with a solution, and look for its further implications.



## TL(5+1), OR “WHAT THE HECK IS THE TECH LEVEL?”

At first glance, steampunk campaign settings appear to be the normal TL5 of the Age of Steam. But the steampunk genre allows marvelous inventions that use steam age technology to achieve results not historically achieved until TL6 or even TL7. Charles Babbage’s design for the Analytical Engine is a good example: a completely workable programmable digital computer, built with entirely mechanical technology. In some campaigns, the GM may allow much greater leaps forward – anti-gravity devices, space travel, genetic engineering, beam weapons, and many other technologies not yet mastered by current scientific methods.

The advanced technology in *GURPS Steampunk* is effectively TL6, but a divergent TL6, one that started at TL5 and went in different directions. As a shorthand notation, it can be called “TL(5+1).” In formulas and tables (such as those for medical care and first aid, p. B128), use the total of the two numbers; that is, this is effectively TL6. But it’s a *different* TL6; engineers and scientists from the standard TL6 receive unfamiliarity penalties (-2; see p. B43) in working with it, and vice versa. (This is in addition to the standard penalties for TL differences, p. B185, if applicable.) The “5” indicates that it branched off at TL5 and that it lacks several of the crucial innovations of the historical TL6.

This doesn’t define a specific divergent technology; in fact, many different divergent technologies are possible, whose users would be as unfamiliar with each other’s methods as with those of historical TL6 (see *Other Variant TLs*, p. 13). *GURPS Steampunk* uses “TL(5+1)” to make it clear that certain skills and devices are not from the historical Age of Steam, but from an alternate, technologically accelerated Victorian age. Except in a paratemporal campaign, where such distinctions may be important, a GM can just call these skills and devices TL6.

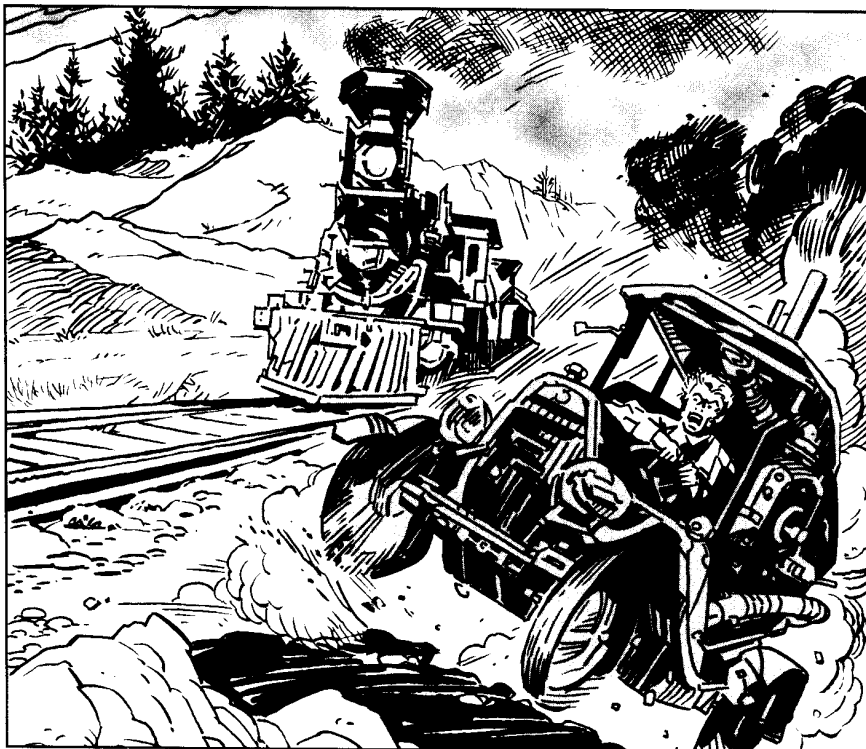

## OTHER EMINENT VICTORIANS

(Continued)

### EDWARD DRINKER COPE (1840-1897) AND OTHNIEL CHARLES MARSH (1831-1899)

The leading American paleontologists of the century, and bitter rivals in their search for new dinosaurs. Cope was a child prodigy who became a Harvard professor at the age of 24.

Marsh was a scion of wealth, whose family bought him a chair at Yale to support his interest in fossils. Originally friendly, they gradually became rivals and then (when Marsh pointed out that Cope had restored a skeleton with the head on the wrong end) bitter foes. At the peak of their careers, they tried to bribe each others’ workers, steal each others’ fossils, and wreck each others’ reputations. The stories of violence between their collecting parties seem only to have been rumors, but in an alternate history, the West could have witnessed a Dinosaur War.

### CHARLES DARWIN (1809-1882)

Arguably the greatest biologist in history and a major cultural figure. Anyone working in biology or geology may interact with him, at least by letter. See pp. WWi100-101.

### THOMAS EDISON (1847-1931)

Perhaps the best-remembered inventor of his century; he combined his own ingenuity and self-taught technical skills with the ability to manage a large and underpaid technical staff – and a conscious cultivation of his own public image. A particularly notable episode in his life was the controversy over direct vs. alternating current, in which he backed direct current and invented the electric chair to demonstrate the dangers of alternating current.

### JOHN ERICSSON (1803-1889)

A Swedish engineer who emigrated to the United States, where he revolutionized naval warfare by building the *Monitor* during the American Civil War.

### MICHAEL FARADAY (1791-1867)

Originally trained as a chemist, he turned in 1831 to the investigation of electricity and magnetism. He developed the concept of fields of force (the basis for James Maxwell’s theoretical work), demonstrated electromagnetic induction (the production of an electric current by a changing magnetic field), and invented the electric motor and generator.

*Continued on next page . . .*



## OTHER EMINENT VICTORIANS

(Continued)

### RUDYARD KIPLING (1865-1936)

A major Victorian writer whose passions included the British Empire, technology, and competent men and women doing their jobs. See pp. WWi112-113.

### ALFRED KRUPP (1812-1887)

The heir to his family's steel works, he started out manufacturing rail and wheels for railroads, but subsequently turned to armaments, with which his name is now identified. His artillery pieces made a major contribution to the French defeat in the Franco-Prussian War.

### KARL MARX (1818-1883)

Born to a middle-class family of Jewish ancestry, he devoted his life to the labor movement. In 1849 he had to leave the continent for London, where he spent the rest of his life working in the British Museum, subsidized by Friedrich Engels and other friends. In his *Das Kapital (Capital)*, completed from his notes after his death, he predicted that the future development of economic forces would make the victory of socialism inevitable.

### MATTHEW FONTAINE MAURY (1806-1873)

An American naval officer who helped to create the science of oceanography; his naval career ended after the Civil War, when he backed the Confederacy. Verne puts his books in Captain Nemo's library.

### JAMES CLERK MAXWELL (1831-1879)

A brilliant theoretical physicist, he developed both the electromagnetic equations, which predicted the existence of radio waves, and statistical mechanics, which explained the laws of thermodynamics in terms of the random motions of molecules.

### JOHN STUART MILL (1806-1873)

Often considered one of the most brilliant intellects in history, Mill did important work in logic and scientific method, economics, and political theory, and advocated utilitarianism in ethics ("the greatest good of the greatest number"), libertarianism in politics, and equal rights for women.

### FLORENCE NIGHTINGALE (1820-1910)

After a religious conversion at 17, she took up a career in nursing, serving in the Crimean War of 1854, and became a leading advocate of improved medical care for wounded soldiers.

Continued on next page . . .

## OTHER PLACES AND TIMES

Great Britain dominated the 19th century, thanks largely to its navy, and for much of that century Queen Victoria was on the throne (1837-1901). Because of this, Victorian England is the natural reference point for a steampunk campaign. But a variety of other settings could also work and have been used in steampunk worlds of literature, film, television, comics, or games.

The United States was a major center of technological innovations in this century; Americans loved to boast about "Yankee ingenuity" and the basement tinkerer became an American archetype. Foreign countries often accepted this American mythology – many of Jules Verne's inventor heroes were Americans or were active in the United States. The American railroad system played a key role both in the Civil War, one of the first wars to use industrial technology, and in the settlement of the West. Age of Steam inventions could easily fit into an adventure campaign. Consider the gadgetry of *The Wild, Wild West* – a prototype steampunk series long before the term was coined!

A variety of colonial settings offer steampunk possibilities. Imagine a French Foreign Legion with powered armor or airships, or a British Raj administered with huge steam computers. Or what if the colonized nations tried to fight back with the aid of advanced technology? Jules Verne's *Twenty Thousand Leagues under the Sea* suggests such a struggle, with the exiled Indian prince "Captain Nemo" waging war against the civilized world from his submarine.

The non-European nation that followed this path most successfully, and in fact never came under foreign control, was Japan. The Meiji Restoration was followed by a determined and successful effort to modernize Japan's government, industry, and armed forces. Had steampunk technologies been available, Japan would have done everything possible to acquire them, as Gibson and Sterling suggest in *The Difference Engine*. An anime-based campaign could explore this era – steampunk is a popular genre in Japanese animation (for the theme of fighting back against the West, see the episode "A Tale of Two Robots" in the film *Robot Carnival*). Or a martial arts campaign could add Age of Steam technology to traditional ninja gadgetry.

Many European powers, not just Great Britain, could also develop Age of Steam technology. Realistically, rail transport and large-scale industry helped create the large nation-states that dominated Europe and reached out for colonies elsewhere by the end of the century. High-performance vehicles, powered armor, and high-speed mechanical cryptography, computation of artillery fire, and simulation of battle plans could accelerate this process. Romantically, advanced inventions might enable a smaller nation to preserve its independence – or gain it. In either type of setting, advanced technology could become a focus of espionage and sabotage.

The relative political stability of the 19th century began before Victoria's reign, with the end of the Napoleonic wars in 1815, and lasted after it, until the start of the Great War in 1914. A steampunk campaign could be set in either period, though one set after 1900 would have some TL6 technology, probably including internal combustion, powered flight, and radio. Delaying or avoiding the Great War could allow even later steampunk worlds.



# OTHER AGES OF STEAM

The real Age of Steam was a specific period in Earth's history, and most steampunk is set in that period. But with more radical divergences, it's possible to imagine similar technologies in other settings, earlier or later. A classic of alternative history, Keith Roberts' *Pavane*, portrays one such Age of Steam: a 20th century derived from the assassination of Elizabeth I and the conquest of England by the Spanish Armada. Some other possibilities are included in the Infinite Worlds setting for *GURPS*: the present of Roma Aeterna (pp. AE52-69), Ezcalli (pp. AE90-106), and Ming-3 (pp. AET31-49), and the recent past of Cornwallis (pp. AET11-30) and Aeolus (pp. AET90-108). A perennial favorite for speculators, though hardly plausible, is a history where Hero of Alexandria's steam engine became more than a toy.



It's also possible to have similar changes in worldview and social organization emerge from entirely different technologies. The past of Caliph (pp. AET69-89) offers one such model, with Near Eastern petroleum as the fuel for Muslim industrialization. Alchemists discovering metal-acid batteries and then the effect of electric currents on a compass needle could lead to electrically based industrialization. Variant natural laws might allow other paths to an age of exploration and invention.

For a wildly variant steam age, the alternative technology could be based on magic, psionics, or chi, either alone or in combination with the physical sciences. See the sidebar *Incorporating Magic* (p. 12).

## THE STEAMPUNK GENRE

## OTHER EMINENT VICTORIANS

(Continued)

### ALFRED NOBEL (1833-1896)

In his youth, Nobel studied with John Ericsson. He invented dynamite in 1866 and became wealthy. Disappointed in his hope that dynamite would make war so terrifying that it would be abandoned, he used his fortune to set up the Nobel Prizes, including the Nobel Peace Prize, first awarded in 1901.

### LOUIS PASTEUR (1822-1895)

Trained as a chemist, he discovered that organic molecules typically exist in two forms, left- and right-handed, of which living organisms use only one form. He went on to make revolutionary discoveries in microbiology, including vaccines for anthrax and rabies and the technique of sterilization by heat, and act as a consultant to the French wine industry. In 1868 a stroke paralyzed his left side, but he continued his experimental work by giving directions to assistants.

### ALLAN PINKERTON (1819-1884)

Founder of the first private detective agency in 1850. His agents played a major role in the American Civil War and later gained a reputation for suppressing labor unions. See pp. WWi84-85.

### CECIL RHODES (1853-1902)

One of the 19th century's great empire builders, he made a fortune by gaining control of the Transvaal mines, served as Prime Minister of the Cape Colony, and brought most of southern Africa under British control.

### NIKOLA TESLA (1856-1943)

Edison's greatest rival and his leading opponent in the debate over direct vs. alternating current, Tesla was a brilliant and eccentric engineer and a figure of legend among his contemporaries. See pp. AE107-125 and WWi110-111.

### WILLIAM WALKER (1824-1860)

An American adventurer who conquered Nicaragua. Walker was then overthrown by Cornelius Vanderbilt after he nationalized Vanderbilt's Nicaraguan holdings. See pp. AE11-32 and WWi88-89.

### BOOKER T. WASHINGTON (1856-1915)

Born a slave, Washington gained an education under extremely difficult conditions, worked as a teacher, and eventually became a major black leader and the founder of the Tuskegee Institute (1881). He emphasized self-help, and in his later life was criticized for his willingness to work within the system.

Continued on next page . . .

## OTHER EMINENT VICTORIANS

(Continued)

### H.G. WELLS (1866-1946)

A student of T. H. Huxley, he turned to writing in the 1890s while incapacitated by tuberculosis and invented most of the key ideas of 20th-century science fiction before becoming a founding member of the Fabian Socialists in 1901.

### INCORPORATING MAGIC

The essence of steampunk, as defined here, is a certain kind of technology. But the "steampunk" label has also been applied to fantasy set in the 19th century by such authors as James Blaylock and Tim Powers. One roleplaying game, *Castle Falkenstein* (now available in a *GURPS* version), combines a high fantasy 19th century with steam technology. So how does magic fit into steampunk?

### TECHNOLOGY WITHOUT MAGIC

The simplest option, and the one most of this book will follow, is to say that magic does not exist. Mainstream Victorian science was materialistic, envisioning the universe as a mechanism controlled by unchanging laws. Treat the world as a no-mana area. People should marvel at the scientific vision, the human mind's power to comprehend it, and the inventions it permits, not at childish fantasies.

### TECHNOLOGY VERSUS MAGIC

Another approach is that magic used to be possible, but has grown rare, especially in the civilized world. Perhaps the mana has been drained, or cold iron or the rationalism of civilized people suppresses magic; or perhaps the two are still in conflict, such as in the *Windrose Chronicles* by Barbara Hambly. There may be pockets of magic in distant lands or magical objects in ancient tombs. Treat the world as a low-mana area, with no-mana and normal-mana sites. Knowledge of magic requires at least a 10-point Unusual Background.

### MAGIC AND TECHNOLOGY COEXISTING

For a third approach, magic could be widely available, with a Royal College of Sorcerers and an alchemist in every town – but with 19th-century society unchanged. Treat the world as a normal-mana area. For an interesting variation, treat consecrated ground as high-mana for believers, but low-mana for deniers. This approach is best suited to a light campaign.

*Continued on next page . . .*

# SOCIETY, CULTURE, AND "PUNK"

So where's the "punk" in steampunk?

Cyberpunk embodies a distinctively late-20th-century sensibility: not just cynicism about whether people live up to social laws and ideals, but cynicism about whether those laws and ideals are worth living up to in the first place. It suggests that social customs are a mask for oppression, exploitation, and conflict. Its heroes are people on the losing end of this conflict, who recognize their situation for what it is and disregard law and custom when they need to or when it suits them. In other words, it expresses a sense of alienation far removed from the straightforward moral values of the Victorian era. When it expresses a similar sense of alienation, steampunk is anachronistic, a late-20th-century vision of the 19th century.

But the idea of the 19th century as a time of unquestioned moral standards and social consensus is just as much an anachronism. Such standards were preached to schoolchildren, and heroes of popular fiction often followed them . . . but characters in serious literature, and most real people, faced more complex problems. In fact, all the elements of the cyberpunk outlook already existed in 19th-century society – but not necessarily together.

Despite its comparatively tranquil surface, the politics of the time was filled with turmoil. In 1848, for example, popular unrest swept across Europe, shaking several monarchies and replacing the French monarchy with the Second Republic. Radical political movements advocated ideologies from laissez-faire to socialism to outright nihilism, or specific reforms such as the Single Tax or equal rights for women.



## THE STEAMPUNK GENRE



The working classes began to organize politically, at the risk of criminal penalties or even death. Karl Marx, Pierre Joseph Proudhon, and others competed for influence over organized labor. Otto von Bismarck bought off labor's demands with measures such as Europe's first social security system. At the same time, writers began to portray common people not as comic relief but as heroic or tragic figures. The punk embrace of lower-class culture has 19th-century roots.

Intellectuals began to question both religion and morality. It became safe for the first time in centuries to reject Christianity openly. Early in the century the Utilitarians proposed to reexamine all moral questions, not in terms of "the laws of nature and of nature's God," but on the basis of calculations of pleasure and pain. The complete rejection of morality was less common, but people were aware of it as a possibility.

A different kind of rejection of morality showed up in artistic circles, in the aesthetic celebration of decadence. Writers from Baudelaire to Wilde praised an aristocratic dandyism divorced from the old aristocratic social duties; the phrase "fashion statement" would have made perfect sense to the decadents. Others, such as the writer and artist William Morris, rejected industrialism and called for a return to medieval folkways.

Alienation and psychological distress troubled many people; for example, John Stuart Mill, one of the leading Utilitarians, experienced a nervous breakdown in his early twenties. Many literary characters embody even deeper alienation, whether as social outcasts such as Heathcliff in *Wuthering Heights* or as literally alien beings such as Frankenstein's monster.

In short, if players want their characters to be outsiders or criminals or revolutionaries, they can find historical and literary prototypes. On the other hand, if players want to play decent, honorable people, the code of decent conduct is there for them to live by, and most people will respect them for trying to do so. How seriously they take the "punk" in steampunk is up to them.



## INCORPORATING MAGIC

(Continued)

### MAGIC AS TECHNOLOGY

A more radical variation is to assume that advanced magical techniques produced a different industrial revolution, with the social issues of the real 19th century but different causes. The entire world may be a normal-mana or high-mana area – or even a very-high-mana area with spectacular "industrial accidents." This is a fantasy analog of steampunk rather than steampunk proper, but some of the material in this book applies.

### OTHER VARIANT TLS

Can Age of Steam technology advance even farther than TL(5+1)? Some of the fiction of the time certainly assumes this; for example, Wells' Eloi and Morlocks live thousands of years in the future, in a world totally remade by science – but one whose basic technology is still steam. *GURPS Steampunk* doesn't attempt to provide rules for such advances, but the GM who wants to define TL(5+2) or TL(5+n) is free to do so. Otherwise, just go from TL(5+1) back to TL7 as technology advances.

The same TL(x+n) notation could be used for earlier or later divergences. For example, a "clockpunk" world based on Renaissance inventors' dreams might be described as TL(4+1); its ornithopters, clockwork automata, and powerful springs would achieve TL5 or TL6 results by entirely different methods. At least two published *GURPS* settings can be described in such terms: Gernsback (pp. AE107-125) is TL(6+1), and the Tech stages of *GURPS Lensman* are TL(6+1) to (6+6) (see pp. L65). A really divergent technological path might even be called, say, TL(0+8) to describe a world of highly advanced bio-tech and limited physics. Regardless of how early or late the divergence occurred, only one -2 skill penalty for unfamiliarity should be applied; after all, TL7 mechanical engineers do still learn about steam engines and gears.

Keep three things in mind when defining such variants. First, such notations as TL(5+1) don't indicate a *specific* variant path; they apply equally well to many different variants. There's no need for further complications such as "TL(4+1+1)" (or, for that matter, "TL(7-1)"). Second, for most purposes, all that matters is the total of the two numbers; TL(5+1) and TL(4+2) can just as well be called TL6. Use the more complicated notation only when it's necessary to distinguish between standard and nonstandard ways of attaining the same general level of capability, as it is in this book.



# CHAPTER 2 THE SPIRIT OF THE AGE

*The invader had come across the frontier on the very dawn of the war in half-a-dozen parallel columns behind a cloud of cyclists and cavalry, with a general air of coming straight on the capital, and the defender horsemen had held him up, and peppered him and forced him to open out to outflank, and had then bolted to the next position in the most approved style, for a couple of days, until in the afternoon, bump! they had the invader against their prepared lines of defense.*  
— H.G. Wells, "The Land Ironclads"



## TIMELINE, 1815-1914

What is the essence of steampunk? What makes a world, a story, or a campaign part of the steampunk genre? Retrotech and gadgets are the most obvious ingredients, but there is more to it than steam-powered flying machines and difference engines. Steampunk imagines new inventions and discoveries in a historical setting, the Age of Steam, and it is this setting that lends the gadgets their context. It is changes in history, as much as changes in technology, that make steampunk so fascinating. A steampunk campaign can be set in the real 19th century, with the addition of one or two marvelous inventions, or in an alternative 19th century created by a different technology, or even in an entirely different Age of Steam set on a faraway world. But in order to experiment with alternate history, it's useful to know something about the real flow of history.

This chapter explores major trends in 19th-century history and considers how they might have been changed, or how they might appear in a different setting. The sidebars provide a timeline of real historical events, including not just political and military history but inventions, discoveries, and theories.

# SCIENCE, INVENTION, AND INDUSTRY

During the 19th century, science and technology advanced with unprecedented speed. At the start of the century, technological innovation was mostly based on craft skills rather than theoretical science. Often, technology was invented first and the theory to explain it was developed afterward, as when Sadi Carnot developed the theory of heat engines to explain steam power. By the century's end, the trend had reversed, and many laboratory curiosities had become commercially valuable: radio from Maxwell's electromagnetic equations, dyes from organic chemistry, and pasteurized foods from Louis Pasteur's work in microbiology.



In 1815 Newtonian mechanics was solidly established, providing explanations for planetary orbits, the trajectories of cannonballs, and the operation of machines. The wave theory of light had been proposed but not proven or fully worked out. By 1914, the wave theory of light had been absorbed into electromagnetic theory, and the problem of reconciling electromagnetism with mechanics had given rise to Albert Einstein's theory of relativity (best treated as early TL6). Other major new theories in the physical sciences included thermodynamics and statistical mechanics, while Darwinian evolution and Mendelian genetics radically altered the biological sciences. In addition, science offered a new vision of the history of the world, going back hundreds of millions of years to the still unexplained formation of the solar system and forward to the eventual "heat death" of the cosmos.



The concept of energy was central both to theoretical science and to engineering. The law of conservation of energy was proposed and its implications were worked out, including the impossibility of perpetual motion machines. Physicists envisioned natural processes in terms of conversion of energy from one form to another. Engineers tried to make those conversions more efficient in steam engines and other devices. Concerns for fuel economy gave rise to energy measurement techniques and the science of thermodynamics.

1815

The Congress of Vienna establishes new European boundaries; Napoleon briefly returns from Elba, is defeated at Waterloo, and is banished to St. Helena; the British government abolishes income tax.

The Analytical Society is founded at Cambridge, with the goal of introducing Continental mathematics into Britain.

Robert Fulton builds the U.S.S. *Fulton*, the first steam warship, for the U.S. Navy.

1817-1825

Construction of the Erie Canal in New York.

1817

Simon Bolivar establishes an independent government in Venezuela; in subsequent years most of the rest of Spanish America gains independence.

John Kidd extracts naphthalene from coal tar.

David Ricardo publishes *The Principles of Political Economy and Taxation*.

1818

The *Savannah* is the first steamship to cross the Atlantic, taking 26 days.

1819

The British East India Company establishes a settlement in Singapore.

1820

The Prince Regent succeeds his father George III as George IV.

The Missouri Compromise brings Maine into the Union as a free state and Missouri as a slave state.

1821

The Catholic Church lifts its ban on teaching the Copernican system.

1822-1829

The Greeks declare independence from the Ottoman Empire and gain autonomy with European aid.

1822

Britain repeals the death penalty for over 100 crimes.

Jean-Francois Champollion translates the Rosetta Stone.

The Royal Asiatic Society is founded.

Charles Babbage begins plans for the Difference Engine.

1823

Proclamation of the Monroe Doctrine.

Mechanics' Institutes are founded in London and Glasgow.

*Continued on next page . . .*



## TIMELINE, 1815-1914

(Continued)

1825

The Stockton and Darlington Railroad offers the first passenger rail service.

Thomas Telford builds the Menai Bridge, the first large-scale suspension bridge.

The first horse-drawn omnibuses are established in London.

1826-1832

A cholera epidemic begins in India and eventually reaches Europe and the British Isles.

1827

Joseph Smith founds the Church of Jesus Christ of Latter-Day Saints.

Joseph Ressel invents the screw propeller.

Karl Baedeker publishes his first travel guides.

1828

Britain allows Catholics and Dissenters to hold public office.

Friedrich Wöhler synthesizes urea in the laboratory, showing that organic compounds can be produced outside of living organisms.

Construction begins on the Baltimore and Ohio Railroad, the first in North America.

1829

The Metropolitan Police Force is founded in London.

James Smithson leaves £100,000 to fund the Smithsonian Institution in Washington, D.C.

James Mill publishes a description of the human mind as a machine, *Analysis of the Phenomena of the Human Mind*.

1830

George IV dies and is succeeded by his brother William IV.

1831

Belgium gains independence from the Netherlands under King Leopold I.

Charles Darwin leaves England on the H.M.S. *Beagle*.

1832, 1835

Electoral reforms in Great Britain abolish "rotten boroughs," reform local government, and increase the number of citizens eligible to vote.

*Continued on next page . . .*

The steam engine gave the 19th century a new energy source for vehicles and factories, supplementing or replacing human and animal muscle, water, and wind. Early engines burned wood, but by 1830 British engines burned coal, creating the first fossil fuel economy – and a terrible source of pollution. Britain industrialized far faster than any other country; British fossil fuel use in 1830 was not equaled until 1880 in the United States, 1890 in Germany, and 1900 in France. Raw materials from all over the world came to British factories and finished goods went back out, creating wealth that made London the financial capital of the world. British investments paid for much of the industrial development of the United States, and simply exporting beef to the British Isles made Argentina one of the world's 10 richest nations.

### What If?

Could industrialization have begun elsewhere? Britain had unusual advantages: a thriving commercial economy, cheap shipboard transportation, large supplies of good coal, and iron ore close to the coal or easily transported by shipping. A coal-based industrial revolution would probably need all these advantages. The Netherlands might be a plausible starting place; in the 19th century Belgium industrialized more rapidly than any other nation on the Continent, with the help of rich coal deposits. Or if Europe's industrialization stalled, the Pittsburgh area of North America, also rich in coal, might be able to industrialize once it had a large enough population and economy, perhaps in the late 19th century.



The other fossil fuel option is oil. Could industrialization have started either with oil-fueled steam engines or with a direct jump to internal combustion? Again, Pennsylvania might be a starting place for this kind of industrialization. Given more rapid scientific advances, the oil-rich Near East could be an alternative starting place; it had both a commercial economy and widespread shipping at its height.

Slower industrialization might take place through improved methods of harnessing wind and water. For example, what if alchemical experiments with acids led to the invention of the battery and then of motors and generators? Power lines could have spread out from major rivers, allowing small factories with motors and electric lighting to spring up.

Alternative industrial revolutions might also involve a different relationship between scientific theory and technology. Scientific research might find technological applications earlier, even as early as the Roman Empire; what if Hero of Alexandria had come up with a practical application for his aelopile? On the other hand, industrial technology might develop through tinkering with no scientific basis. Steam and steel might be even more central to such an economy, without the distractions of chemistry and electricity.

## GEOGRAPHY AND EXPLORATION

In 1815, large parts of the world were unknown to Europeans, particularly the Arctic and Antarctic and the interiors of Africa and Australia. By 1914, only a few remote places remained unmapped: the Arctic and Antarctic, whose conquest was a major goal for explorers, and a few other places such as the interior of New Guinea.

In part, this came about because of improved transportation and communication: the steamship, the railroad, the telegraph, and powered flight. But all these modern technologies had limits. Airships and airplanes could fly over unknown terrain, but landing was risky. Ships depended on oceans or rivers. Railroads and telegraphy required large investments and operated along fixed routes. At a certain point, exploration fell back on the oldest means of travel: walking and riding.

The 19th century made heroes of its explorers. To find the sources of the Nile or the North Pole, to reach unprecedented heights in the atmosphere or on mountain tops or unprecedented depths in the ocean, was a guarantee of fame. Nearly as good was making new discoveries, collecting exotic birds or unearthing the ruins of Troy.

After the explorers came the colonizers. Trappers, farmers, and miners came to the new lands to work and earn a living. Naturally, settlers often faced hostility or open warfare from the native inhabitants they pushed aside, such as the Indian tribes of North America, the Maori of New Zealand, and the Zulus of South Africa. The settlers standing off such attacks became heroes to their contemporaries, as did the soldiers who sometimes rode to their rescue. The tribal warriors were heroes to their own people and sometimes gained grudging respect from their white adversaries, especially after they were safely defeated.

European powers set up colonial governments, with authority both over settlers and over the native peoples. Latin America gained independence during the Napoleonic wars, but large parts of Asia and nearly all of Africa and the Pacific came under European control, first opportunistically as trading posts and coaling stations, and later in a systematic division of the world by the great powers. In 1900, nearly all the sovereign governments of the world were European or American.

## TIMELINE, 1815-1914

(Continued)

1832

Charles Babbage publishes *The Economy of Machines and Manufactures*, calling for the integration of scientific research, invention, and industry.

1833

Slavery is abolished in the British Empire.  
William Whewell coins the word *scientist*.

1834

The German states form the *Zollverein*, or free trade area.

The Spanish Inquisition is abolished.

Charles Babbage develops plans for his Analytical Engine.

1835-1836

Texas gains independence from Mexico.

1835

Samuel Colt patents the first revolver.

1836

The Chartist movement in Great Britain demands universal suffrage (for men, of course).

Boers in South Africa begin "the Great Trek" across the Orange River. They found Natal, the Orange Free State, and the Transvaal as independent states.

1837

William IV dies, ending the personal union of Great Britain and Hanover, and is succeeded in Great Britain by Victoria, crowned in 1838.

Samuel Morse patents the electric telegraph and introduces Morse code.

1839-1842

The First Opium War: Britain forces China to accept the opium trade and gains possession of Hong Kong.

1839

J.L. Stephens begins excavation of the ancient Mayan city of Copan.

Charles Goodyear develops vulcanized rubber.

Louis Daguerre develops photography.  
The Cunard Lines are founded.

1840

Victoria marries Albert of Saxe-Coburg-Gotha.

*Continued on next page . . .*

## TIMELINE, 1815-1914

(Continued)

1841

New Zealand becomes a British colony, leading to a series of Maori uprisings from 1845 to 1872.

Richard Owen coins the word "dinosaur."

1842

C.W. Long introduces the use of ether for surgical anesthesia.

1843

James Joule quantifies the conversion of work into heat, the basis for the law of conservation of energy.

The first night club, Le Bal des Anglais, opens in Paris.

1844

Samuel Morse sets up telegraph lines between Washington and Baltimore.

Karl Marx and Friedrich Engels meet in Paris.

1845

Texas joins the United States.

William M'Naught develops the compound-expansion steam engine.

1846-1848

The United States and Mexico are at war; the United States wins.

1846

The planet Neptune is discovered.

William Thomson (later Lord Kelvin) estimates the age of the Earth at 100,000,000 years based on temperature measurements.

Elias Howe patents the sewing machine.

1847

Cyrus McCormick begins the manufacture of mechanical reapers.

1848

Antimonarchist revolutions take place throughout Europe; the Second Republic is established in France under Louis Napoleon.

Otto von Bismarck and Karl Marx both found newspapers.

Karl Marx and Friedrich Engels write the *Communist Manifesto*.

James Bogardus constructs the first building with a cast-iron frame.

1849

A gold rush begins in northern California.

1850-1864

The Taiping Rebellion takes place in China.

Continued on next page...

## What If?

What if colonialism had not changed form after 1880? A world where large areas outside Europe remained unclaimed and unmapped would offer many settings for adventure stories. A less intense rivalry among the European powers, or a different expression of it, might leave large areas of *terra incognita*.

Or what if explorers had opened up even more distant frontiers? The obvious example would be the other planets, especially if Mars and Venus were not just reachable but at least marginally habitable. Many science fiction novels have envisioned space exploration in terms taken from 19th-century colonialism. Closer to home, if there really were vast realms under the earth – a cavern stretching from Iceland to Sicily and similar subterranean realms elsewhere – would it take long for expeditions to seek mineral wealth or prehistoric lifeforms?

## WARFARE

Warfare in the 19th century wasn't the most important source of new technologies. From the telegraph to the steam turbine, many new inventions were developed for civilian use years before the military tried them in battle. But especially in the second half-century, technology changed the nature of war.

## LAND WARFARE

The European powers of the 19th century inherited and developed Napoleon's military methods. Armies were made up of three basic forces, infantry, cavalry, and artillery, supported by engineers, signalers, surgeons, and an increasing number of other noncombatant troops. The bulk of any army was the infantry; the other two forces were specialists, who needed the infantry to survive. Artillery killed ever increasing numbers of soldiers from ever increasing ranges, but had little defensive strength at close quarters; prudent generals used the infantry to shield their big guns. Cavalry served largely as scouts and skirmishers, but in actual battle their superior weight could overwhelm foot soldiers and their speed let them move to escape a defeat or pursue the enemy after a victory.



Both small arms and artillery became more lethal. Soldiers could no longer stand up in ranks blazing away at each other, or march steadily forward against the increasing volume of fire they faced. After the middle of the century, they spent as much time as possible under cover, even during battles. The front ranks became more widely spaced, as any mass of men presented too easy a target. Improved small arms and early automatic weapons allowed a smaller number of men to hold off the same number of enemy forces.

Steam power had little direct effect in battle, because it was tied to railroads that were often remote from battlefields. But railroads could move masses of men, horses, and arms quickly and cheaply. Naturally, seizing or destroying them became a major strategic objective, which made it all the more urgent for generals to keep the fighting as far from the railroads as possible. Telegraph lines and other signaling systems could carry messages from the front lines to headquarters, so intercepting or interfering with signals became another strategic goal. Aerial observation posts in balloons provided another source of strategic information.



The flow of information became so huge that a new system for handling it was needed. Napoleon created the first general staff as an improvisation; the Prussian army made staff work a science. On the Continent, staff officers gathered and analyzed intelligence, developed plans of battle, mapped possible battlefields and wrote firing orders for artillery, and worked out railroad timetables, among many other functions. Many people thought military strategy could be calculated in advance and set to run automatically. This produced some memorable disasters, as commanders at the front held to rigid plans of battle or waited, paralyzed, for orders from the rear. But despite these excesses, no country could afford to be without a general staff; even Britain created one in 1900, after the humiliations of the Boer War.

### What If?

Steampunk technology could radically transform the face of war in the 19th century. Steam engines could power ironclad land vehicles or even massive personal armor, with effects comparable to those of the introduction of the tank. Steam-powered calculating engines could determine trajectories for artillery, work out railroad timetables, or even plan battles through wargaming. Such innovations might be accelerated by a less peaceful 19th century, or might emerge later on as experiments in a steampunk 20th century under a prolonged Pax Britannica.

## NAVAL WARFARE

For the first part of the 19th century, naval warfare continued to rely on sailing ships. Paddle wheels were too vulnerable to cannon fire; even once the screw propeller was adopted, early steam engines were less reliable than the wind and so inefficient that no ship could carry fuel for a long ocean voyage. Tactics followed Age of Sail principles, firing broadsides at close range and then boarding and capturing enemy ships.

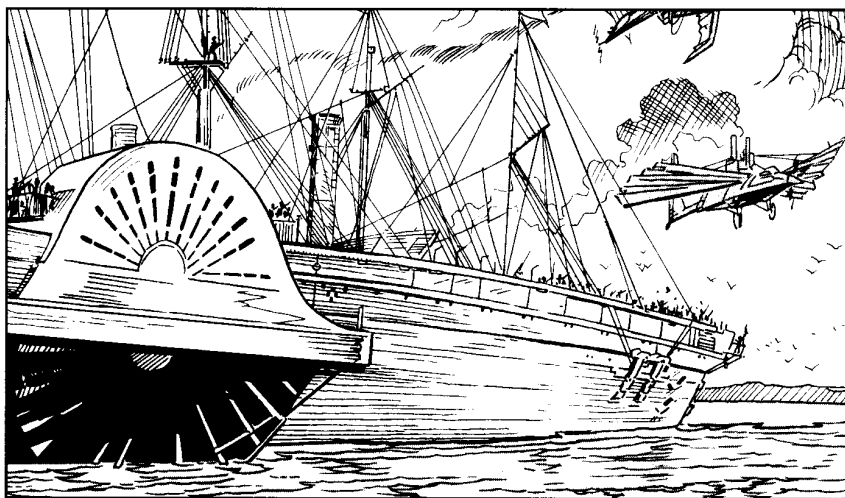

The second half of the century saw many technological innovations – more efficient steam engines and, eventually, the abandonment of sails; iron armor and then iron hulls; large naval guns, firing shells rather than cannonballs, mounted centrally on rotating turrets. But navies weren't quite sure what to do with the new technologies. Navies mixed wild experiments – for a brief period, ironclads were even equipped with rams – with a conservative reliance on Age of Sail tactics, doing battle at ranges of a mile or less.

## TIMELINE, 1815-1914

(Continued)

1851

The Great Exhibition is held in England with the encouragement of Prince Albert. One of its main attractions is the Crystal Palace, a glass and iron building.

1852

Louis Napoleon establishes the Second Empire as Napoleon III.

Henri Giffard builds the first steam-powered dirigible.

E.G. Otis invents the safety elevator.

1853-1856

The Crimean War: Russia is defeated by the Ottoman Empire and its allies Great Britain and France.

1853

Colonel Samuel Colt begins manufacturing revolvers.

Alexander Wood invents the hypodermic syringe.

Chloroform gains acceptance when given to Queen Victoria during birth of her eighth child.

1854

Matthew Peary opens Japan to Western trade.

George Boole develops mathematical logic.

1856

The first Neanderthal remains are discovered.

W.H. Perkin produces aniline purple, the first synthetic dye.

Henry Bessemer develops a process for making steel in large quantities.

"Big Ben" is cast at the Whitechapel Bell Factory.

1857-1858

The Indian Mutiny leads to direct administration of India by the British government.

1857

Speculation in U.S. railway shares causes European financial crisis.

The Russian serfs are emancipated.

1858

Darwin and Wallace communicate the theory of evolution by natural selection to the Linnaean Society.

Launching of the *Great Eastern*, the largest ship of the time (27,000 tons).

1859-1869

The Suez Canal is built in Egypt.

*Continued on next page . . .*

## TIMELINE, 1815-1914

(Continued)

1859

R.L.G. Planté invents the first practical storage battery.

1861-1865

The American Civil War ends in the defeat of the South; as a byproduct, slavery is abolished.

1861

Victor Emmanuel II of Sardinia is enthroned as king of a unified Italy.

1862-1869

The Union Pacific Railway, the first transcontinental railroad in North America, is constructed.

1862

Otto von Bismarck becomes the Prime Minister of Prussia.

R.J. Gatling invents the Gatling gun.

The first battle between ironclad ships, the *Monitor* and the *Virginia*, takes place.

1864

Karl Marx founds the First International Workingmen's Association in London and New York.

Pope Pius IX condemns liberalism, rationalism, and socialism in the *Syllabus Errorum*.

The first Geneva Convention establishes the neutrality of medical facilities in war.

1865

The laying of a transatlantic telegraph cable is completed by the steamship *Great Eastern*.

James Clerk Maxwell publishes his electromagnetic equations.

Joseph Lister develops antiseptic surgery.

Gregor Mendel publishes his work on genetics, which is ignored.

1866

The Austro-Prussian War ends in a rapid Prussian victory and establishes Prussian dominance over the North German Federation.

Alfred Nobel invents dynamite.

1867

Canada is organized as a Dominion.

Russia sells Alaska to the United States.

Diamonds are discovered in South Africa.

*Continued on next page . . .*

Early iron ships had belts of armor at deck height, but none below the waterline. The invention of the torpedo meant that a small ship could sink the largest battleship. To counter this threat, naval architects developed the torpedo-boat destroyer (later called simply "destroyer"), a fast, lightly armored ship that could screen battleships from torpedo boats and later from submarines, as cavalry helped screen artillery from infantry in land warfare. A mix of light, fast ships and slow, heavy ships became standard.

The real revolution in naval warfare came at the end of the Age of Steam, during the Russo-Japanese War, when ships fired at each other from a distance of several miles. The scale of naval engagements expanded, and long-range fire directed from observation stations high above the deck became standard. A new class of battleship, the dreadnought, with a steel hull and steam turbines, carrying five or more turrets with long-range guns, made all other ships obsolete.

### What If?

Innovations might have been more rapid if the century had been less peaceful. A serious challenge from Britain's rivals, especially the technophilic French, could have forced tactical innovations, with long-range combat and the dreadnought coming into use a decade early. More radical advances might have allowed the birth of submarine warfare.

Earlier ages of steam might have been capable of similar innovations. For example, Chinese junks were propelled by treadmill-powered paddle wheels as early as the 5th century, and Korean turtle ships with rams, iron decks, and archery ports were used against the Japanese in 1592-1598. Combined with steam power, such innovations might have given the Far East formidable navies.

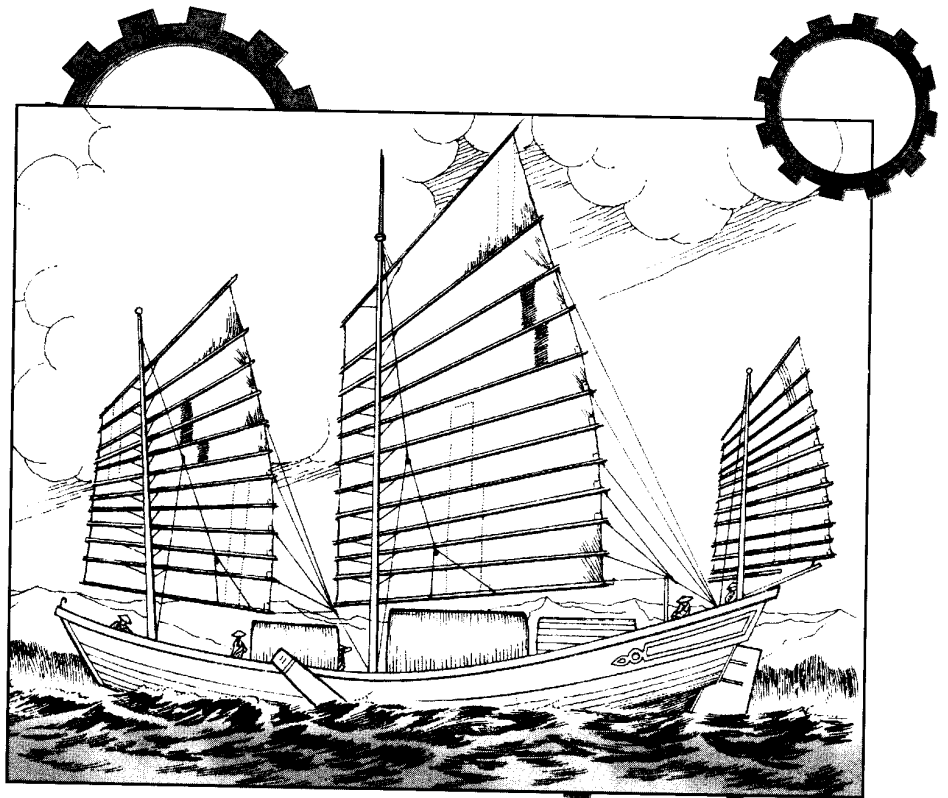

# AERIAL WARFARE

## What If?

The use of balloons for observation and transport goes back to the Napoleonic Wars. But the lack of a method of propulsion limited the balloon's usefulness. What if airships had developed earlier, or airplanes later? Fleets of aerial warships might have bombed enemy troops, or shot each other down with small cannon, or even crossed the oceans. Seagoing fleets might have been dominated by huge floating airship bases, protected from enemy fleets not by their own guns but by the airships they supplied and supported.

Romantic fiction tended to envision all these technological innovations, on land, sea, or air, as the creation of a single inventor or a single nation, who would gain a massive advantage over all rivals. An idealist might use them in a crusade for peace; a megalomaniac might see them as a pathway to power. Realistically, technological innovations were less important than having the industrial capacity to exploit them fully, as Britain did in building the world's largest navy; and the most important use for that navy was to protect the shipping that allowed Britain to specialize in heavy industry. Any steampunk future, or any alternative steampunk past, is likely to use key military technologies to secure their economic health.

## ORGANIZATIONS

Organizations in the 19th century, whether private or public, were small. At the height of Britain's global power, the British army numbered only 200,000, one-third in India supported by a roughly equal number of native troops. The armies of continental powers averaged half a million in the 1870s. Command was also the work of small groups; for example, the Prussian general staff numbered less than 100 during the 1860s. Similarly, industrial plants at midcentury averaged under 50 employees, and few firms owned more than one plant; a large factory had hundreds of employees and capital in the tens of thousands of pounds.

In this period, very few businesses were organized as corporations. Limited liability (meaning that a corporation's shareholders could not be sued personally for acts or debts of the corporation) was regarded as a special legal privilege; corporations were chartered by acts of Parliament (or of state legislatures in the United States). In previous centuries corporations had normally been granted monopolies by national governments, allowing them to charge high prices that were popularly resented. In addition, many investors believed that corporate managers cared more about their own salaries and perks than about corporate profits or share prices. Stock exchanges in London, New York, and elsewhere originally traded mainly in the stock of banks and insurance companies, not industrial firms.

Large-scale business began with the railroads. A railroad had to have substantial plants in at least two cities, and successful ones linked many cities. Train schedules had to be coordinated over hundreds of miles of track for trains to avoid collisions. The telegraph made this possible by letting the crew of a train inform the central office of any delays.

## TIMELINE, 1815-1914

(Continued)

1868

The shogunate is abolished in Japan; the Meiji Dynasty is established and begins to modernize and Westernize Japan.

1869

Thomas Edison creates his first successful invention, the stock ticker.

Dmitri Mendeleev publishes the Periodic Table.

Francis Galton publishes *Hereditary Genius*, the first major work on eugenics.

1870-1871

The Franco-Prussian war leads quickly to a French defeat. The Parisians revolt and found the Paris Commune, but are then defeated by the Prussians. The King of Prussia becomes the Emperor of Germany. Italy takes advantage of French distraction to seize Rome from the Pope.

1871

Heinrich Schliemann begins the excavation of Troy.

1873

The British close the Zanzibar slave market.

1874

The Remington Arms Company begins to manufacture typewriters.

Mary Outerbridge introduces the British sport of lawn tennis into the United States.

1875

Britain buys Isma'il Pasha's share of the Suez Canal.

1876

Alexander Graham Bell invents the telephone.

1877

Queen Victoria is proclaimed Empress of India.

Giovanni Schiaparelli describes channels (*canali*, later mistranslated "canals") on Mars.

1879

The Zulu War: Rebellious Zulus massacre British soldiers at Isandlwana but are eventually defeated. In an incident of the war, the exiled French Prince Imperial, Napoleon, is ambushed by Zulu warriors and killed.

Thomas Edison invents the incandescent light.

Continued on next page . . .



## TIMELINE, 1815-1914

(Continued)

1881

Louis Pasteur develops the first artificial vaccine, effective against anthrax in sheep.  
The Vatican archives are first opened to scholars.

1882

Hiram Maxim invents the machine gun.

1883

The Orient Express begins operation.  
Krakatoa erupts in the Dutch East Indies, creating a tsunami that kills 36,000 in Java and Sumatra.  
Nikola Tesla invents the electric motor.

1884

The Berlin Conference recognizes European spheres of influence in Africa.  
Greenwich time established as the international standard at a meeting in Washington, D.C.

1885

Leopold II of Belgium takes personal possession of the Congo.  
Sir Francis Galton proves the individuality of fingerprints.

1886-1896

A hydroelectric plant is constructed at Niagara Falls.

1888

Heinrich Hertz produces and detects radio waves.  
Jack the Ripper murders six London prostitutes.

1889

Frederick Abel invents cordite.  
The Eiffel Tower is built in Paris; it is then the world's tallest structure (993 ft.).

1890

Thomas Edison arranges the first electrocution to demonstrate the dangers of alternating current.  
Herman Hollerith develops a punched card reader for use in tabulating U.S. Census returns.

1891-1917

The Trans-Siberian Railroad is built.

*Continued on next page . . .*

Big businesses developed later in heavy industry, including steel, petroleum, chemical manufactures, and shipyards, as economies of scale gained recognition. Industrial organization began to resemble military organization, with each factory having multiple administrative ranks, in place of the older style with the owner acting as supervisor and a clerk keeping the books. Public alarm at the market power of large firms led to demands for government regulation, such as the antitrust laws of the United States.

Operating on this new scale, industrial plants needed more systematic administrative methods than before. A new class of efficiency experts emerged, typified by Frank and Lillian Gilbreth and Frederick Taylor. Time-and-motion studies provided a basis for redesigning work processes in factories – and aroused resentment from workers who felt that the experts were trying to increase their workload.

Systematic administration also gained strength in government. In the United States, reformers abolished the spoils system, in which the political party that won an election could give government jobs to its supporters, in favor of the civil service system, in which a staff of professional civil servants provided administrative continuity. In Britain, elected members of Parliament serving as cabinet ministers were assisted by permanent undersecretaries and other appointed staff. In the navy, for example, the First Lord of the Admiralty, a member of the Cabinet, headed a Board of Admiralty with four civilians and four naval officers, the Sea Lords; essential policy was made by the First Lord of the Admiralty, the First Sea Lord, and the Director of Naval Intelligence, a naval staff officer.



### What If?

The development of mechanical computation would change the emphasis of these developments in interesting ways. Clerical staffs, small by 20th-century standards, could become even smaller if machines took over their routine functions. The mass of workers or soldiers, and of foremen or sergeants to give them orders, might become huge. The front office or top command and its support staff would still be as small as in the 19th century. On the other hand, the sense of being just a cog in a machine would be all the stronger if routine administration was mechanized.

# POLITICS

Once the Napoleonic wars ended, the 19th century was a period of comparative stability. From 1815 to 1914, there were no all-encompassing wars between Great Power alliances; the system of European states and diplomatic relations established at the Congress of Vienna limited the spread of hostilities so that the original combatants did not drag in their allies. On the fringes, the Crimea and the American Civil War left little impression on European society, while a series of quick, intense wars unified Germany with minimal disruption. More resources than usual were available for exploration and colonization, scientific research, economic growth, and education and the arts.

One reason for this stability was that the world had a single superpower: Great Britain. In 1815, the British navy had just over half the world's naval strength, and it never fell much below this level for the next hundred years. This enabled the British to build an overseas empire, to suppress piracy and the slave trade, and to enjoy the luxury of a small volunteer army.

Governments didn't fight with each other as much as they worried about conflict between social classes. The Congress of Vienna tried to put kings and aristocrats back in control, but without lasting success. On the continent, in 1848, popular uprisings threatened many monarchies and established a Second Republic in France. In the aftermath, Karl Marx, expelled from Prussia and France, went to live in London. Britain, already a commercial nation with a strong parliament, experienced public unrest as early as the 1820s. In the early 1830s the conservatives granted increased voting rights, toleration of religious dissent, and repeal of import taxes on foreign grain.

The revolutionary idea was alive elsewhere in the world, also. Nearly all of Spanish America declared independence, though the resulting governments were unstable and their economies failed to achieve the rapid economic growth of the United States. In the following decades, the slaveholding plantation economies that reached from the southern United States to Brazil were transformed by the abolition of slavery. This entailed a major war in the United States; reform elsewhere was peaceful, but slower.

Germany and Italy started the period as patchworks of small kingdoms. Italy was unified in 1861; Germany in 1871 under the leadership of Prussia and its chancellor, Bismarck. German unification faced French opposition and was only completed after the Franco-Prussian War, in which France was humiliated by Prussian military skill and by the Paris Commune's revolt. After this, German heavy industry, scientific research, and military skill – and Bismarck's diplomacy – made Germany one of the major powers of the time.

In Asia, after the Meiji Restoration, Japan followed a vigorous program of modernization. This paid off in victories in the Sino-Japanese and Russo-Japanese Wars, which established Japan as a major power.

Through most of the 19th century, Britain's main rival was France, especially after the French alliance with Russia in the 1880s. The main worry about Germany, for the British, was that it might join the French and Russians and shift the balance of power. France and Britain came to the edge of war after the Fashoda incident in the Sudan in 1898 (see p. AET9). Even so, at the start of the 20th century, most people thought peace and prosperity would go on forever.

What destabilized them was a shift in alliances, as Germany forged links with Austria-Hungary and the Ottoman Empire, while France and Russia allied with Britain. Rigid requirements for mutual defense were included in the terms of the new alliances. When Austria-Hungary declared war on Serbia in 1914, the rest of Europe was drawn in, and later the United States. The Great War ended Britain's status as the world's one superpower.

## TIMELINE, 1815-1914

(Continued)

1895

Grace Chisholm Young receives a Ph.D. in mathematics, becoming the first woman awarded a doctorate at a German university. Wilhelm Röntgen discovers X-rays.

1896

A.H. Becquerel discovers radioactivity. X-rays are first used in medicine.

1897

Queen Victoria's Diamond Jubilee is held. At a naval review, Charles Parsons demonstrates the superior speed of his turbine-powered ship, the *Turbinia*, previously ignored by the British navy.

1898

The Spanish-American War: Cuba becomes independent, and Guam, the Philippines, and Puerto Rico are ceded to the United States.

Ferdinand von Zeppelin builds his first airship.

Maria Sklodowska Curie isolates radium.

1899-1902

The Boer War ends in British annexation of the Orange Free State and the Transvaal.

1900

The Boxer Rebellion attempts to expel foreigners from China.

R. A. Fessenden transmits the human voice by radio.

1901

Guglielmo Marconi sends the first transatlantic radio signal from England to Newfoundland.

Establishment of U.S. National Bureau of Standards.

Karl Landsteiner identifies blood types A, B, and O.

1903

Wilbur and Orville Wright demonstrate powered heavier-than-air flight.

1904-1915

The United States takes over and completes the construction of the Panama Canal.

1904-1905

The Russo-Japanese War ends in Japanese victory.

*Continued on next page . . .*

## REPRESENTATIVE GOVERNMENT

Britain's government had been based on elected representatives since the Restoration, but in 1815, Parliament was only vaguely representative of the people it governed. Counties sent two representatives each to Parliament, but in addition, boroughs (local communities that had been chartered by the Crown), each sent one representative. These boroughs remained even if the population dwindled. At the end of the 18th century, 51 parliamentary constituencies had fewer than 50 qualified voters; Old Sarum had *no* inhabitants but still retained its vote. These "rotten" boroughs were the focus of many political strategies, as it was cheap to buy their support for a bill.

The Reform Act of 1832 did away with the rotten boroughs and also gave the vote to the middle classes. Manufacturing cities such as Birmingham and Manchester gained political influence for the first time, and the free trade policies favored by many industrialists commanded many more votes. The Second Reform Act of 1867 gave the vote to a large part of the urban working classes. "Manhood suffrage" was a popular slogan through most of the century. The modern system of political parties took shape, with the Conservative Benjamin Disraeli and the Liberal William Gladstone as key figures.

### TIMELINE, 1815-1914

(Continued)

1904

John Fleming invents the first vacuum tube, a diode rectifier.

1905

Sweden grants Norwegian independence.  
William Haywood leads the formation of the anarchistic Industrial Workers of the World in the United States.

Albert Einhorn introduces novocaine for local anesthesia.

The first U-boat is launched.

1906

A major earthquake (Richter scale 8.3) devastates San Francisco.

The British navy launches the H.M.S. *Dreadnought*, the world's most powerful battleship (see pp. 79-80).

1908

Robert Goddard begins experiments in rocketry.

Henry Ford manufactures the Model T.

Major inventions include the hard-rock oil drill and tractors with moving treads.

1909

Paul Ehrlich develops the Salvarsan treatment for syphilis.

Robert Peary reaches the North Pole.

1911

Sun Yat-sen becomes the first president of China after the fall of the Qing Dynasty.

Roald Amundsen reaches the South Pole, one month before Robert Scott, who dies in the attempt.

1912

The *Titanic* sinks on her maiden voyage; 1,500 people are drowned.

Pitldown Man hoax is staged in England.

1913

Henry Ford sets up the first assembly line, reducing the time to build an automobile from 12.5 to 1.5 hours.

1914

The assassination of Archduke Francis Ferdinand of Austria begins the Great War and ends an era.





## What If?

The Pax Britannica allowed widespread trade and rapid industrialization, with civilian technology advancing more rapidly than military. What if steam power had developed during a period of general warfare? The drain of wealth and manpower into the military might have slowed technological innovation, or shifted it into wartime applications with little economic payoff. Massive engines of war might have come into use, powered by huge steam engines.

For another variation, suppose the Napoleonic Wars had ended in a French victory, with Britain incorporated into the French Empire? Some historians believe the multiplicity of European governments allowed the market economy more freedom to grow. A unified Europe might have industrialized far more slowly. Or industry might have started later, in the United States or in a British emigrant community in Canada or India.

Another path to European unity might be a more successful revolutionary period. The early labor movements pointedly called themselves "international." What if the middle of the century had seen monarchies fall all over Europe?

Similar political factors might shape other steam ages. Unified land empires might have overregulated economies and develop new technology slowly; multiple smaller states might generate dynamic economies and more rapid progress, especially if some of the states created maritime empires with widely scattered trading posts and colonies. In an East Asian maritime expansion, for example, either Japan or Korea might make an interesting industrial power.

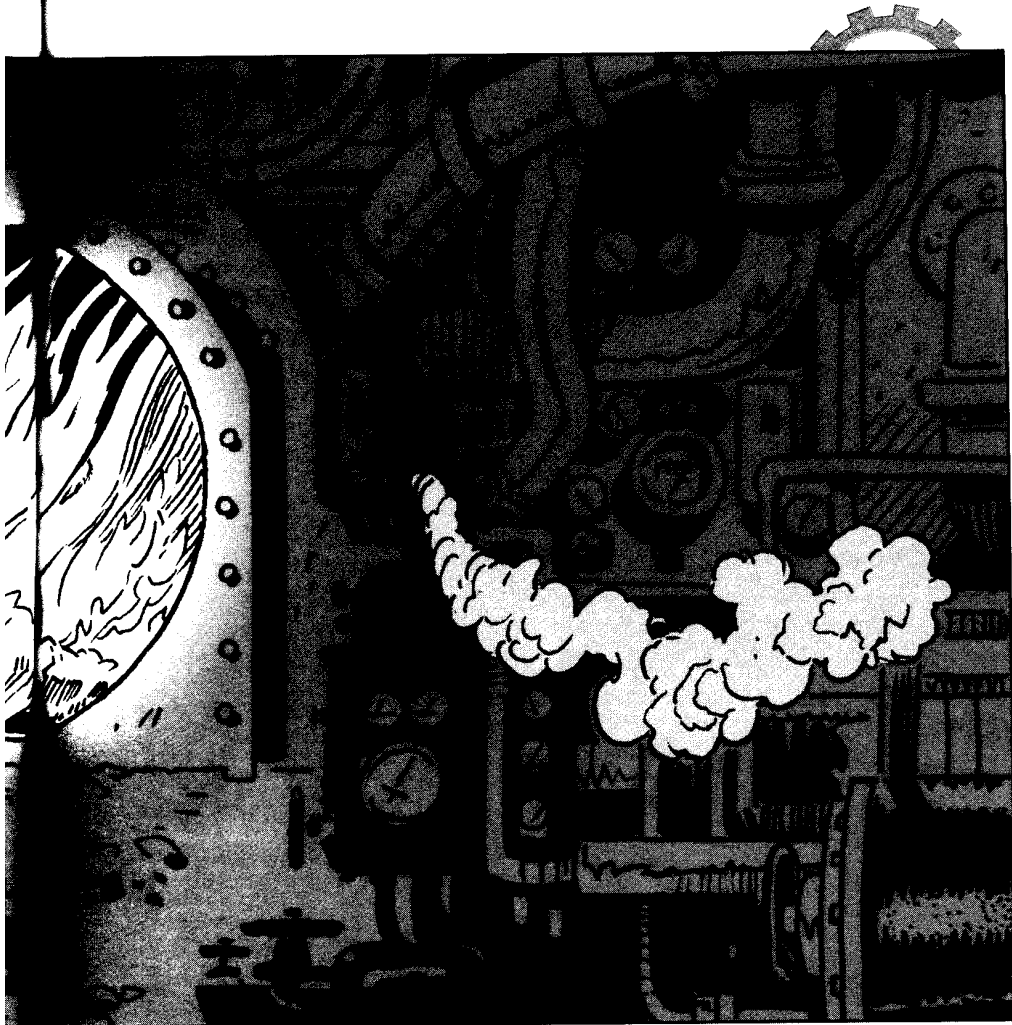

## THE SPIRIT OF THE AGE

## THE DEPTH OF THE PAST

Early in the 19th century, geologists were divided between catastrophists, who attributed geological features to cataclysms (often including the Biblical flood), and uniformitarians, who attributed them to the imperceptible action of ordinary natural processes over time. (In the uniformitarian tradition, Darwin carefully measured how much soil earthworms added to his property.) For uniformitarian explanations to work, the Earth had to be millions of years old, and geologists such as James Hutton and Charles Lyell argued that it was. Their successors established the sequence of geological strata and named the ages when they were formed (see *GURPS Dinosaurs*), though in the 19th century the time span represented by each age was uncertain.

The discovery of human fossils and artifacts and the identification of the Paleolithic, Mesolithic, and Neolithic ages extended human existence further into the Earth's past. Once Darwin proposed his theory of human evolution, the search for earlier ancestors grew more intense; paleontologists hoped to find a "missing link" between men and apes.

Archeologists extended the record of human civilization. Egypt became a major preoccupation of Victorian writers; the first novel about a revived mummy was published in 1827. The discovery of bilingual and multilingual documents such as the Rosetta Stone made it possible to read dead languages and decipher Egyptian and Mesopotamian historical records.

Another approach to ancient languages began in India in 1786, when Sir William Jones pointed out that similarities between Sanskrit, Greek, and Latin suggested that the three had a common ancestor, leading to recognition of the Indo-European family of languages (called Aryan until the Nazis discredited the word). Later linguists attempted to reconstruct the original Indo-European language; one even wrote a fable in his version of it.

## PRIMITIVE MAN

Many Victorians thought they had another window on the distant past: tribal peoples of their own time. Evolutionary theory suggested an analogy: the Australian aborigines, the Inuit, the Bushmen, and similar peoples were human "living fossils," remnants of past ages who had failed to evolve. The customs (or supposed customs) of these peoples were taken as evidence of how Stone Age man lived; for example, Engels wrote about primitive communism and group marriage.

A number of 19th-century criminologists suggested that criminals were also living primitives: unintelligent, impulsive, and given to solving their problems by physical force.

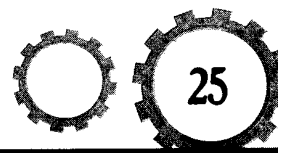

# SOCIAL CLASSES AND DAILY LIFE

## THE VICTORIAN SAFETY NET

Victorian writers from Charles Dickens to Karl Marx paint vivid pictures of the sufferings of the poor (and see Emile Zola's work for a French perspective). There was nothing like the 20th-century welfare state; the first social security system was created by Bismarck in Germany, and English-speaking countries didn't rush to imitate it.

So what happened to the poor? If a man lost his job, did his family face a choice of the workhouse or starvation?

Actually, there were more options than that. A substantial amount of aid went to the poor – but not much of it by way of the government. Churches ran relief programs, as the Mormons and Salvation Army still do. Private charities operated on a large scale for the first time. In addition, one of the customs of the time was that the wealthy should spend part of their money in helping the poor; going out to call on poor families was part of many rich women's weekly or monthly routine.

In the United States, another source of aid was Civil War pensions. These were originally modest, but year by year amounts increased and eligibility widened. Eventually nearly everyone who had fought on either side was enrolled, making this an unofficial equivalent of welfare under a more palatable name.

Finally, the poor did a fair amount to help themselves. This was the great age of lodges and fraternal organizations. One function of these organizations was to provide for their members: to help them find jobs if they were out of work, to support them if they were too sick to work, to bury them when they died. In an age with relatively little public assistance, fraternal societies were not a casual social activity, but served vital practical functions.

Ironically, a major barrier to assistance to the poor was the unwillingness of the poor to accept it. In the first place, not being self-supporting was seen as shameful, and many men and women were reluctant to admit their poverty. In the second place, aid to the poor often had unpleasant side effects ranging from the harsh conditions of the workhouses to condescension and meddling from one's "betters." (Charity Organization Services, a private charity, was nicknamed "Cringe Or Starve.") The desperately proud poor man or woman is an archetypal character of the era.

The 19th century was an era of exceptional social mobility. Commerce and industry created new ways to get rich, ways open – more or less – to any man with energy, ambition, and a good idea. The "self-made man" is a Victorian archetype, and not only for Britain; the French talked of "careers open to talents."

However, all these societies remained stratified. At the top in most European countries were the aristocrats, set aside not just by wealth but by the source of their wealth: inheritance from their ancestors, especially inheritance of land. Making money "in trade" was simply not done by the best people, any more than was manual labor. Even the democratic United States distinguished between "new money" and "old money." Aristocratic fortunes paid for large houses, for servants to run them, and for horses and carriages. The new rich and the middle classes imitated this way of life, as far as they could afford to, and called themselves gentlemen and ladies; having at least one servant was proof of respectability, and more people worked in domestic service than in any other nonfarm job. Higher levels of status went with having a manservant (as men earned more than women) and keeping a carriage.



Despite the growth of the middle class, the majority were still poor. But industrialization improved their lives, especially in Britain, which had the world's highest standard of living. Wages were about the same at the end of the century as at the start, but many products grew cheaper, thanks to increased production. Workers could afford canned food, railway tickets, and telegrams; in fact, working class families spent more on train fares than the rich, who had carriages.

Population increased rapidly, partly because it was easier for a man to support a family. Reduced mortality contributed as well; there were few effective medical treatments, other than vaccination for smallpox, but nutrition and sanitation improved. Much of the increased population ended up in large cities. Railroads and bicycles let the cities expand horizontally; iron and steel-framed buildings let them expand vertically, creating the characteristic 20th-century urban skyline. For the first time, city people outnumbered country people in a few countries.

In parallel with big business, organized labor came into being in the 19th century. Labor unions faced many obstacles; they were sometimes illegal, and even when they were legal there was nothing to prevent an employer from firing a man who organized or joined one, or hiring the Pinkertons or calling the police to suppress strikes. In response, unions functioned as conspiracies, sometimes aspiring to organize a socialist or anarchist revolution. Business owners might find their property destroyed or the strikebreakers they hired intimidated or beaten. These conflicts offered many opportunities for drama, whether from the viewpoint of the heroic labor organizer facing down company goons or from that of the entrepreneur whose business is crippled by union demands. Both viewpoints can be found in the fiction of the time.

### What If?

This combination of industrialization with aristocratic tradition could easily have been different. What if the revolutionary movements had been more successful? If Parliament had not granted the demands of Britain's Chartists in the 1830s, for example, popular unrest might have done away with the aristocracy and the established church and at least stripped the monarchy of its remaining power. Uprisings on the Continent in 1848 could have had similar effects. Later in the century, workingmen's associations advocated the overthrow of capitalism; what if socialism had really been established in Britain or some other advanced nation?

## THE WORLD OF IDEAS

A major change took place in 19th-century thought: the Christian worldview lost some of its power. Certainly most people of European descent still considered themselves Christians. But religious tolerance gained increasing support in many countries; the answer to religious dissent was preaching and debate, rather than the penal code. Freedom to adhere to different versions of Christianity led to freedom to disbelieve.

## THE SPIRIT OF THE AGE

### SEPARATE SPHERES

In the 19th century, men and women lived much more separate lives than is common now. Men had jobs, where they often worked long hours, and where their fellow employees were almost always men. Poor women who had jobs worked among other women; middle- and upper-class women usually had no jobs at all. Instead, they supervised the servants, visited each other, and performed good works.

Social custom allowed young men and women to see each other, but restricted the times and places and prevented them from being alone together; the mere possibility that something might happen between them could damage a young woman's reputation. And after a couple married, though they lived together, they spent much of their time apart.

As a result, men seldom had female friends, and women seldom had male friends; apart from the difficulty of spending time together without scandal, they often had few common interests. Noteworthy exceptions did occur, especially among "advanced" thinkers – Charles Babbage and Ada Byron are an example, as are John Stuart Mill and Harriet Martineau. But spending a great deal of time in single-sex groups, or having close friends only of one's own sex, was entirely normal.

### THE SCANDALOUS VICTORIANS

The Victorian era has a straitlaced reputation, one that in many respects is deserved. But while its morality was stricter overall, there were exceptions – in fact, on some issues, Victorian tolerance has been replaced by 20th-century restrictiveness. To capture the flavor of the time, think of it as *different* more than *prudish*.

### SMOKING

There were no laws against tobacco use in the 19th century, not even for schoolchildren. But at least in the middle and upper classes, there was a strict etiquette for smokers.

It was understood that some people might find smoking offensive. One did not smoke in the presence of one's superiors unless invited to do so. Ladies outranked gentlemen and often found smoking repulsive, so after dinner gentlemen went into a separate room for brandy and cigars. The smoking jacket was invented to keep the smell of tobacco off one's regular clothing. The question "shall we join the ladies?" was the signal to leave the smoking room.

Under less formal circumstances, one might ask permission to smoke, especially of one's equals. And in environments where ladies were not expected to be present, including bars and many businesses, men might smoke freely. (Barmaids didn't count as ladies; they were servants.)

Women were not supposed to smoke at all, though some did – normally in private, to avoid getting a bad reputation.

Continued on next page . . .

## THE SCANDALOUS VICTORIANS

(Continued)

### SOFT DRINKS

Carbonated water was invented by Joseph Priestly in the late 18th century, but the temperance movement created the soft drink industry in the 19th, as an alternative to beer and wine. Ginger beer, sarsaparilla, and similar formulations, made by small manufacturers for mainly local distribution, came into wide use in the English-speaking countries, though not on the continent, where temperance never really caught on. Many households acquired a *gazogene*, a device for carbonating water or other liquids.



### PROSTITUTION

The 19th century demanded that women protect their chastity at almost any cost; phrases such as "a ruined woman" and "a fate worse than death" were meant seriously. But at the same time, prostitution was a thriving industry. In fact, there were several different strata of prostitution, from demimondaines or adventuresses whose informal liaisons with prosperous men might be as stable and as exclusive as a marriage, through house girls, down to the streetwalkers among whom Jack the Ripper found his victims.

Many people thought prostitution gave men an outlet for impulses that otherwise would endanger every woman they encountered. Many, possibly most men were at least occasional customers of prostitutes; it was fairly common for them to have their first sexual experiences this way. In an era when there was no safe treatment for sexually transmitted diseases, this was a significant public health problem.

*Continued on next page . . .*

The emergence of the scientific worldview gave Christianity a rival system of beliefs. Educated people learned about heliocentric astronomy and debated the age of the earth and Darwin's theory of evolution; scientists such as Galileo became heroic martyrs. And for the general public, technological advances and demonstrations of scientific discoveries offered wonders as amazing as the feats of saints or prophets. Some historians began to suggest that the Bible was simply another mythology, no better or worse than the fables of Greece and Rome or the folktales of primitive tribes. The many supporters of Christianity now had to preach not just against sin, but against doubt and secularization.

The idea of sin also lost some of its power, as some unbelievers took the next logical step: questioning Christian morality. A few rejected morality entirely in favor of the freedom to be a beast of prey or the personal vision of the artist – and sometimes behaved scandalously and, even worse, talked openly about doing so, rather than keeping up the appearance of respectability. Others looked for a nonreligious basis for morality, such as the utilitarians' principle of "the greatest good of the greatest number."

Such ideas inspired a variety of new political movements, which no longer accepted the divine right of kings or the need for a religious basis for political authority. Secular political theories included utopian socialism, several forms of revolutionary socialism (Karl Marx and Mikhail Bakunin fought bitterly for control of the First International), laissez-faire capitalism, imperialism, racialism, and more narrowly focused movements such as Henry George's Single Tax and William Jennings Bryan's support for Free Silver. Once radical ideas such as the abolition of slavery and a widespread right to vote gained general acceptance – though even in 1914 few women were able to vote.

Literature and the arts also saw new movements. The romantics had popularized the idea of unique individual genius in the arts; artists in later movements pursued their personal visions with increasing disregard for older ideas of proper style and decorum. They found inspiration in a variety of sources. The Pre-Raphaelites, led by William Morris, advocated a return to the Middle Ages (including a revival of the guild system). Many artists, including Vincent Van Gogh, were influenced by *japonaiserie*, an artistic fad for Japanese imports, and toward the end of the era, artists such as Pablo Picasso began looking to African and other "primitive" art for inspiration. At the same time, such figures as Charles Baudelaire, Algernon Charles Swinburne, and Oscar Wilde glorified the artist's freedom from bourgeois morality.

### What If?

One of these movements suggests an intriguingly different image for an Age of Steam: What if Morris's medievalism had been more successful, establishing a popular style in design? Imagine an early 20th century with locomotives shaped like dragons and skyscrapers in the form of medieval towers!

For a different variant, suppose the Christian revival movements of the later 19th century had been even more successful than they were. Might they have slowed the development of new scientific theories and the spread of consumer capitalism, while encouraging hard work and private charity, and thus prolonged both the technology and the cultural idiom of the Age of Steam? A Christian peace movement might even avert the catastrophe of the Great War.





# LOOKING FORWARD

If religious doctrines about the human past could be questioned, so could religious doctrines about the human future. Many writers in the Age of Steam developed their own visions of the future, whether as fictional speculations or as scientific predictions. Aside from being interesting in their own right, such speculations may be useful as sources for campaign settings.

In the near future, many people anticipated continuing improvement in human civilization and possibly even in human beings. The simplest visions imagined huge cities filled with technological wonders. More optimistic writers imagined an improvement in civilization, an end to war, or an era of perfect freedom. Marx and Engels had just such expectations, though they were unusual in thinking the better future would be achieved through violent overthrow of existing society. Some writers even thought eugenics (selective breeding of humanity) might improve later generations.

However, other writers took a more pessimistic view, anticipating that their civilization might fall, as the civilizations of the ancient world had fallen. W.S. Jevons, the founder of mathematical economics, made his reputation with *The Coal Question*, a book that predicted the exhaustion of British coal, followed by the collapse of British industry, commerce, and military power. (Jevons discussed solar power briefly but dismissed oil completely.) Marx's prediction of class warfare might point to the fall of civilization, for those who didn't share Marx's optimism about the outcome of a workers' revolution. Or if all these catastrophes were avoided, perhaps the very perfection of civilization would eliminate all challenges and condemn the human race to decadence, an idea Wells considered in *The Time Machine*.

In considering the far future, Victorians asked why should the human race last forever, when millions of other species had become extinct? Mary Shelley's *The Last Man*, though less famous than *Frankenstein*, may have been the first novel to show the human race dying out from natural causes. In *The Time Machine*, Wells portrayed a dying Earth under a swollen red sun, devoid of anything resembling human life.

Still further in the future, the Age of Steam envisioned the entire universe coming to an end through the operation of the Second Law of Thermodynamics. In effect, this "heat death" would be the whole universe running out of fuel, with no way to obtain more – an image that still haunts cosmologists a century later. In fact, not knowing about nuclear energy, the Victorians thought the heat death of the universe was relatively close at hand; Wells envisioned the sun running out of energy in another 30 million years.

A dead universe doesn't offer much prospect for adventure. But either the optimistic near future or the decadent further future might have their own adventurers, striving in one case to extend human civilization and in the other to revitalize it. A different style of campaign might make a point of decadence, with incredibly wealthy aristocrats leading lives devoted to aesthetic refinement, surrounded by half-understood mechanical wonders.

Another way to use such backgrounds is to put actual Victorians into them. Time travelers learning of the human race's approaching extinction, and struggling to prevent it, would provide the basis for any number of adventures. A decadent future such as the world of Wells's childlike aristocratic Eloi and cannibalistic working-class Morlocks might inspire similar efforts.

One-way time travel is another option. A group of sleepers waking up to a decadent civilization, an Earth empty of humanity, or a universe of fading red dwarf stars could provide an exotic setting for storylines about the struggle to survive and rebuild civilization.

## THE SPIRIT OF THE AGE

## THE SCANDALOUS VICTORIANS

(Continued)

### WOMEN AND SEXUALITY

Victorians held the stereotype that women were incapable of sexual pleasure and endured their husbands' attentions out of affection and a desire for children. For many women, this was true. But Victorian medicine recognized that widows, women unsatisfactorily married, and young women ready for marriage might have unmet physiological needs. The long-established treatment was massage of the procreative organs to induce a convulsive state called "hysterical paroxysm." This was not viewed as a sexual act (after all, sexual intercourse did not produce such states), though doctors such as Freud's teacher Charcot recognized some connection with sexuality.

Originally, this treatment was performed manually. But this was time-consuming, an hour per patient or more. In the 1880s, doctors began inventing technological aids, vibratory massage equipment that could complete the same treatment in 10 minutes. The first designs were large, floor-mounted units, often powered hydraulically or by small steam engines; electricity made smaller models possible, and by the turn of the century they were widely marketed for home use through mail order catalogs – as a way of restoring health and the glow of youth. Ironically, motion pictures drove them off the market, as early stag films showed their use in unmistakably sexual terms that made them an embarrassment.

### ADULTERY

Another option for the unhappily married was adultery. Both men and women had love affairs, sometimes prolonged ones. In France, it was taken for granted that a man who could afford it would have a mistress, and the upper classes in England made the same assumption, while married women often had love affairs. The important thing was to avoid scandal. A gentleman didn't talk about his conquests, or write explicit love letters, or make physical demonstrations before witnesses; a lady didn't openly leave her husband's house or move into her lover's. If these and other rules were followed, it was possible for an affair to go on for years, sometimes without hard feelings on any side. When Edward VII was on his deathbed in 1910, for example, Queen Alexandra made a point of giving his last mistress a chance to visit him before he died.

Why didn't these couples divorce and remarry as they chose? Apart from the unthinkable scandal that would result, divorce was not easily arranged. In Catholic countries it required approval from the Church; in Protestant England, an Act of Parliament. The people who could afford this could also afford to keep up the appearance of a marriage while doing as they pleased in their private lives.

Such private arrangements, of course, gave opportunities for blackmail – a useful source for plots, as many mystery writers have demonstrated.



## CHAPTER 3

# CHARACTERS

*Oh, I am a cook and a captain bold, And the mate of the Nancy brig,  
And a bo'sun tight, and a midshipmite, And the crew of the captain's gig.*

*— W. S. Gilbert, The Yarn of the Nancy Bell*

A steampunk campaign has room for most of the standard adventurer types, including many described in *GURPS Warriors*. To complement them, this chapter presents some distinctively 19th-century types, with suitable advantages, disadvantages, and skills.

An "everyman" campaign with a 50-point base can work for ordinary people confronting the unknown, or for mechanics working for a brilliant inventor, or for soldiers stationed in

North Africa or on Venus. A more standard 100 points nicely fits the heroes of classic adventure fiction. For aristocrats, 150 points are enough to buy Rank, Status, Wealth, and other social advantages and still leave room for attributes and skills. A campaign with masked or disguised adventurers (not yet called superheroes) can do well at 250 points, perhaps with a 100-point limit on disadvantages, especially if the heroes can gain extraordinary powers from advanced science.

## CHARACTER CONCEPTS

The following templates can aid quick character creation, and serve as a guideline to characters appropriate to the period. Each specifies attributes, advantages, disadvantages, and skills appropriate to a character type. Skills are divided into primary skills, which are absolutely necessary; secondary skills, which are helpful but need not be as fully mastered; and background skills, which could be picked up incidentally in a given occupation or position. Finally, customization notes suggest ways to adapt a template to a variant setting or a different version of the underlying concept.

The template system is a convenience, not a requirement. GMs may choose not to use templates in their campaigns; if they use templates, characters created with and without templates are both allowable. Using a template does not give any discount on point cost or any in-play effect that might unbalance characters. A template is simply a list of choices that work well together, designed to save most of the work of coming up with well-balanced characters, but leaving room for customization. GMs are free to add more templates to the list, as dictated by the needs of a specific campaign.

Reputation is not included in these templates, but could apply to any of them.

### AESTHETE 45 POINTS

You are a young man or woman of education and taste and the money to live accordingly. Depending on which decade it is, you may be a dandy, a pre-Raphaelite, or a *fin de siècle* decadent; your role model may be Byron, Baudelaire, Swinburne, or Wilde – or their female counterparts. Sensible people like Gilbert and Sullivan make jokes about you, and respectable people find you scandalous, but you enjoy making life more beautiful.

**Attributes:** ST 9 [-10]; DX 11 [10]; IQ 13 [30]; HT 9 [-10].

**Advantages:** Fashion Sense [5]; Independent Income [5]; and 15 additional points from Empathy [15] or Sensitive [5]; Alcohol Tolerance [5], Attractiveness [Varies], Claim to Hospitality [5], Comfortable [10], Heir [5], Language Talent [2/level], Manual Dexterity [3/level], Musical Ability [1/level], Status [Varies], Versatile [5], or Voice [10].

**Disadvantages:** A total of -25 points from Addiction [Varies]; Alcoholism [-15]; Code of Honor (Gentleman) [-10]; Compulsive Carousing [Varies];

Enemies (Artistic rivals or critics) [Varies]; Jealousy [-10]; Laziness [-10]; Lecherousness [-15]; Low Pain Threshold [-10]; Manic-Depressive [-20]; Odious Personal Habits (Exaggerated mannerisms) [-5]; Pacifism [Varies]; Secret [Varies]; Skinny [-5]; Social Disease [-5]; Social Stigma (Fallen woman) [-10] or (Sexual deviant) [-15]; or Xenophilia [Varies].

**Primary Skills:** Appreciate Beauty (M/VH) IQ [8]-13 and Savoir-Faire (M/E) IQ+1 [2]-14.

**Secondary Skills:** Carousing (P/A; HT) HT+1 [4]-10; and 6 additional points from Weaving (P/E) DX+1 [2]-12, Singing (P/E; HT) HT+1 [2]-10, Flower Arranging, Gardening, or Musical Notation (M/E) IQ+1 [2]-14; Calligraphy, Dancing, Illumination, or Needlecraft (P/A) DX [2]-11; Architecture, Bard, Gambling, Poetry, or Writing (M/A) IQ [2]-13; or Artist, Bardic Lore, Literature, or Musical Instrument (M/H) IQ-1 [2]-12.



**Background Skills:** A total of 5 points from Guns (Pistol) (P/E), Cloak, Fencing, or Riding (P/A); Hiking (P/A; HT); Acting, Bartender, Fortune Telling, Language (French or Italian), or Occultism; (M/A); Sex Appeal (M/A; HT); or History or Naturalist (M/H).

**Customization Notes:** This template is especially suitable to silly campaigns. Consider the advantage Rapier Wit [5] and the disadvantage Lover's Distraction [-15] for such campaigns. For a really outrageous example of the type, take a Wealth level higher than Comfortable.

## ARMY OR NAVY OFFICER 30 POINTS

You're a commissioned officer in the army or navy of your country. As such, you have the skills of leading and managing a combat force. Background skills are based on typical curricula of 19th-century military academies.

**Attributes:** ST 10 [0]; DX 10 [0]; IQ 11 [10]; HT 10 [0].

**Advantages:** Military Rank 3 [15]; Status 1 [0]; and 10 additional points from Ally [Varies], Charisma [5/level], Comfortable [10], Language Talent [2/level], additional Military Rank [5/level], Patron [Varies], additional Status [5/level], and Strong Will [4/level].

**Disadvantages:** Duty (9 or less) [-5]; and -15 additional points from Bad Temper [-10], Code of Honor (Gentleman) [-10], Delusion (Genteel Proficiency) [-15], additional Duty [Varies], Fanaticism [-15], Overconfidence [-10], Social Stigma (Soldier) [-5], Vow (Parole) [-10], or Workaholic [-5].

**Primary Skills:** Leadership (M/A) IQ+1 [4]-12 and Tactics (M/H) IQ-1 [2]-10.



**Secondary Skills:** Savoir-Faire (Military) (M/E) IQ+1 [2]-12; Administration (M/A) IQ-1 [1]-10; and one of Cartography or Surveying (M/A) IQ-1 [1]-10; or Intelligence Analysis, Navigation, or Strategy (M/H) IQ-2 [1]-9.

**Background Skills:** Law (Military) (M/H) IQ-2 [1]-8/14; and any four of Sports (P/A) DX-1 [1]-9; Language or Writing (M/A) IQ-1 [1]-10; or Chemistry, History, Mathematics, or Physics (M/H) IQ-2 [1]-9.

**Customization Notes:** This template is not complete as written; it represents the leadership, command, and academic skills that officers' training emphasized, with the combat skills excluded. To complete the design, combine it with an appropriate template from *GURPS Warriors* (artillerist, cavalryman, engineer, marine, naval crew, rifleman, scout, and sharpshooter are all in period, while aviator, battlesuit trooper, space crew, and vehicle crew may be justified in specific campaigns) or with combat skills, advantages, and improved attributes worth roughly 75 points. For a senior officer with command or staff experience, add another 25 points in the primary and secondary skills and increased Military Rank.

## CAPTAIN OF INDUSTRY 80 POINTS

You are that quintessential figure of the Age of Steam, the self-made industrialist. You didn't inherit your fortune from aristocratic ancestors; you made it in trade. Most of your abilities are economic or managerial, but you understand the technology of at least one major industry.

**Attributes:** ST 10 [0]; DX 10 [0]; IQ 12 [20]; HT 10 [0].

**Advantages:** Filthy Rich [50]; Status 1 [0]; and 10 additional points from Charisma [5/level], Less Sleep [3/level], Lightning Calculator [5], Single-Minded [5], Strong Will [4/level], or +1 IQ or HT [10].

**Disadvantages:** Duties (12 or less, nonhazardous) [-5] or Workaholic [-5]; and -20 additional points from Age [-3/year over 50], Bad Sight [-10], Bully [-10], Callous [-6], Code of Honor (Merchant's) [-5], Enemies [Varies], Extravagance [-10], Greed [-15], Overconfidence [-10], Overweight [-5], Secret [Varies], Social Stigma [Varies], or Unfit [-5].

**Primary Skills:** Administration (M/A) IQ+1 [4]-13; Merchant (M/A) IQ+3 [8]-15; and one of Architecture, Armoury, Distilling, or Prospecting (M/A) IQ+2 [6]-14; or Chemistry, Computer Programming, Engineer, Metallurgy, Pharmacy, Shipbuilding, or Shiphandling (M/H) IQ+1 [6]-13.

**Secondary Skills:** Accounting (M/H) IQ-1 [2]-11 and Economics (M/H) IQ-1 [2]-11.

**Background Skills:** A total of 3 points in Masonry (P/E), Bard, Hydrology, Mechanics, Research, Sailor, or Surveying (M/A); or Detect Lies, Diplomacy, Geology, or Law (M/H).





**Customization Notes:** Enemies is a very common disadvantage for a captain of industry, and there are many possibilities to choose from; rival capitalists, labor leaders, newspapermen, and politicians are obvious choices. If you made your money off of somebody's stolen invention you could have either an Enemy or a Secret. For a higher point value, add Multimillionaire [25/level].

## CLERGYMAN 60 POINTS

You're a minister, priest, or rabbi, bringing the word of God to your congregation, whether in a fashionable London church or at a mission in a faraway heathen land. You may or may not have supernatural powers, depending on the campaign world; you certainly have Religious Rank and the social privileges it conveys. Your profession requires several abilities reflected in IQ, from self-command to knowledge of sacred texts.

**Attributes:** ST 10 [0]; DX 10 [0]; IQ 13 [30]; HT 10 [0].

**Advantages:** Religious Rank 2 [10]; and 15 points chosen from Charisma [5/level], Empathy [15], Fearlessness [2/level], Imperturbable [10], Language Talent [2/level], Musical Ability [1/level], additional Religious Rank [5/level], Strong Will [4/level], and Voice [10]. Status 1 is free from Religious Rank for some faiths.

**Disadvantages:** Discipline of Faith or Vow [-5]; and -15 points chosen from Absent-Mindedness [-15], Age [-3/year over 50], Compulsive Behavior (Religious observance) [-5], Fanaticism [-15], Honesty [-10], Intolerance [-5 or -10], No Sense of Humor [-10], Pacifism (Cannot kill) [-15], Poverty (Struggling) [-10], Secret [Varies], Sense of Duty

(Coreligionists/Everyone you know/All humanity) [-10/-10/-15], Social Stigma (Minority faith) [-5 or -10], or Truthfulness [-5].

**Primary Skills:** Bard (M/A) IQ-1 [1]-12; Performance/Ritual (M/A) IQ+1 [4]-14; and Theology (M/H) IQ [4]-13.

**Secondary Skills:** Language (Greek, Hebrew, Latin, or Old Church Slavonic) (M/A) IQ-1 [1]-12; and any two of Singing (P/E; HT) HT+1 [2]-11; Poetry, Research, or Teaching (M/A) IQ [2]-13; or Musical Composition or Musical Instrument (M/H) IQ-1 [2]-12.

**Background Skills:** Area Knowledge (Parish) (M/E) IQ+1 [2]-14; and 9 points in any of First Aid or Musical Notation (M/E); Hiking (P/A; HT); Administration, Language (any non-Western), Leadership, Occultism, or Writing (M/A); or Detect Lies, Diplomacy, History, Literature, Naturalist, or Psychology (M/H).

**Customization Notes:** Religious Rank in a minority faith, especially in a religiously intolerant milieu, adds interesting complexities to this archetype, starting with Social Stigma or a Secret. Religious Rank does not confer Status on such a character.

## CREATION VARIABLE

You're an artificial being, not fully part of human society and perhaps not acknowledged as human at all. This is less a template than a category of possible characters. The racial or model cost should be worked out and paid for as a package, even if you are the only example of a given "race." See the sections on analytical engines, mechanical men, and artificial life in Chapters 5 and 6. Any distinctive individual traits may then be added.



An artificially created being has a -10-point Social Stigma (Valuable property), a -15-point Social Stigma (Outlaw, outsider, or barbarian), or a Secret (see pp. C178-79). Mental disadvantages that reflect lack of human social experience are appropriate: Callous [-6], Clueless [-10], Confused [-10], Gullibility [-10], Low Empathy [-15], No Sense of Humor [-10], Oblivious [-3], or Truthfulness [-5]. Amnesia that includes unawareness of who created you can be interesting. The stereotypical created being is large and strong (ST 12, HT 12) but less intelligent than a human being (IQ 9).

## DEMIMONDAINE 70 POINTS

Your position in society is awkward. You aren't a respectable woman, but respectable men enjoy your company and seek you out. You don't exactly sell yourself, but you are willing to have your expenses paid or accept costly gifts. Your personal charm is your greatest asset; your quick wits are nearly as important.

The demimondaine's Code of Honor, if she has one, emphasizes "playing it straight" with her gentleman friends: either forming exclusive alliances or making sure they know the alliance is not exclusive; paying back loans and favors; keeping her social commitments. Of course, it does not include what most women of the period consider essential to their honor.

**Attributes:** ST 10 [0]; DX 10 [0]; IQ 12 [20]; HT 12 [20].

**Advantages:** Charisma +1 [5]; and 20 points chosen from Alcohol Tolerance [5], Attractiveness [Varies], additional levels of Charisma [5/level], Comfortable [10], Cultural Adaptability [25], Empathy [15], Fashion Sense [5], Language Talent [2/level], Musical Ability [1/level], Patron [Varies], Status 1 or 2 [5 or 10], Unusual Background (Trained in exotic techniques) [10], Versatile [5], or Voice [10].

**Disadvantages:** Social Stigma (Demimondaine) [-10]; and -15 points chosen from Addiction [Varies], Alcoholism [-15], Code of Honor [-5], Compulsive Behavior (Flirtation) [-5], Compulsive Carousing [-5], Compulsive Spending [Varies], Impulsiveness [-10], Jealousy [-10], or Lecherousness [-15].

**Primary Skills:** Carousing (P/A; HT) HT+2 [8]-14; Courtesan (M/A) IQ [2]-12; and Sex Appeal (M/A; HT) HT+2 [6]-14.

**Secondary Skills:** Acting (M/A) IQ [2]-12; Savoir-Faire (M/E) IQ [1]-12; and three of Singing (P/E; HT) HT+1 [2]-13; Games or Make-Up (M/E) IQ+1 [2]-13; Dancing or Needlecraft (P/A) DX [2]-10; Gambling, Language (preferably French), or Performance (M/A) IQ [2]-12; or Literature or Musical Instrument (M/H) IQ-1 [2]-11.

**Background Skills:** A total of 5 points in Guns (Pistol) or Knife (P/E); Area Knowledge (City), Cooking, Flower Arranging, or Musical Notation (M/E); Calligraphy (P/A); Disguise, Fast-Talk, Holdout, or Streetwise (M/A); Acrobatics or Erotic Art (P/H); Cryptography or Detect Lies (M/H); or Appreciate Beauty (M/VH).

**Customization Notes:** In a Japanese steampunk campaign, this template can be used to create a geisha; the main change is from Courtesan to the somewhat different professional skill Geisha. For a closer fit, take Geisha-14 and Sex Appeal-12 for the same point cost.

## DETECTIVE 70 POINTS

You may work for a police force or a private agency such as the Pinkertons, or you may be your own boss. In any of these roles, you are a pioneer in systematic investigation. Given the limitations of laboratory methods in your time, you rely as much on legwork as on forensic science. You have modest physical skills, but your trained intelligence is more important.

**Attributes:** ST 10 [0]; DX 11 [10]; IQ 12 [20]; HT 10 [0].

**Advantages:** Alertness +1 [5]; Composed [5]; and an additional 15 points from Administrative Rank [5/level], additional Alertness [5/level], Combat Reflexes [15], Empathy [15], Intuition [15], Legal Enforcement Powers [Varies], Patron [Varies], Sensitive [5], Single-Minded [5], or an additional +1 to IQ [10].



**Disadvantages:** A total of -15 points from Bully [-10]; Curious [Varies]; Duties [Varies]; Edgy [-5]; Fanaticism [-15]; Honesty [-10]; Jealousy [-10]; Overconfidence [-10]; Pacifism (Self-defense only) [-15]; Sadism [-15]; Sense of Duty [Varies]; or Workaholic [-5].

**Primary Skills:** Criminology (M/A) IQ+2 [6]-14; one of Forensics (M/H) IQ [4]-12, Research (M/A) IQ+1 [4]-13, or Streetwise (M/A) IQ+1 [4]-13; and one of Shadowing (M/A) IQ+1 [4]-13 or Stealth (P/A) DX+1 [4]-12.

**Secondary Skills:** Law (M/H) IQ-1 [2]-11; and two of Acting, Disguise, Fast-Talk, Holdout, Intimidation, Lockpicking, Photography, Tracking, or Writing (M/A) IQ+1 [4]-13; or Artist, Cryptanalysis, or Detect Lies (M/H) IQ [4]-12.

**Background Skills:** A total of 6 points in Black Powder Weapons, Guns, or Knife (P/E); Area Knowledge (Community) or Savoir-Faire (M/E); Stealth (P/A); Armoury, Fast-Talk, Languages, or Shadowing (M/A); or Forgery or Poisons (M/H).

**Customization Notes:** A policeman *must* take 5- or 10-point Legal Enforcement Powers and a Duty to the police force; a senior detective (inspector or superintendent) should also add Administrative Rank. Employees of private agencies lack such advantages, but any reputable agency will be licensed to operate and will extricate its detectives from sticky legal situations which arise on the job (but not troubles resulting from blatant stupidity!). As a result, a private agency counts as a Patron. Self-employed detectives had best watch their step; street or police Contacts can help.

## ENGINEER

### 55 POINTS

Whether on a ship, airship, or interplanetary vessel, you're the man who keeps the engines running. The ship's officers may not treat you as an equal, but they depend on your grimy hands. The Scottish accent is optional, though the stereotype (carried into the future by *Star Trek*) was already emerging in the Age of Steam.

**Attributes:** ST 11 [10]; DX 10 [0]; IQ 12 [20]; HT 10 [0].

**Advantages:** Manual Dexterity +1 [3]; and 15 points chosen from Alcohol Tolerance [5], Double-Jointed [5], Lightning Calculator [5], Machine Empathy [15], Mathematical Ability [10], Military Rank [5/level], Temperature Tolerance [1/level], Toughness [Varies], Versatile [5], +1 IQ [10], or additional levels of Manual Dexterity [3/level].

**Disadvantages:** A total of -15 points from Appearance [Varies]; Code of Honor (Keep the ship running) [-5]; Hard of Hearing [-10]; Missing Digit [Varies]; No Sense of Humor [-10]; Oblivious [-3]; Overconfidence [-10]; Status -1 [-5]; Stubbornness [-5]; or Workaholic [-5].

**Primary Skills:** Mechanic (Vehicle Type) (M/A) IQ+4 [6]-16 and Engineer (Vehicles) (M/H) IQ+1 [6]-13.

**Secondary Skills:** Two of Administration (M/A) IQ [2]-12; Blacksmith (M/A) IQ-2 [2]-10\*; Carpentry (M/E) IQ+1 [2]-13; Masonry (P/E) DX+1 [2]-11; Metallurgy (M/H) IQ-1 [2]-11; and Shipbuilding (M/H) IQ-1 [2]-11.

\* Reflects a -2 modifier for ST 11.

**Background Skills:** A total of 6 points in Brawling (P/E); First Aid, Seamanship, or Telegraphy (M/E); Carousing (P/A; HT); Distilling or Leadership (M/A); or Airshipman, Chemistry, Mathematics, or Physics (M/H).

**Customization Notes:** At TL(5+1) Etheric Science (M/VH), Exoskeleton (P/A), Free Fall (P/A), and Vacc Suit (M/A) may become available.



## EXPLORER

### 90 POINTS

You spend your life venturing where no one has gone before, or at least no European. You aren't going to settle down; your goal is to make discoveries and return to report them. You may be looking for ancient ruins, new species of plants or animals, geographic information, or trade routes. Whatever your goal, you measure your success by new knowledge gained – and by whether you live to tell the tale.

**Attributes:** ST 10 [0]; DX 10 [0]; IQ 11 [10]; HT 13 [30].

**Advantages:** Fit [5]; and 25 points from Absolute Direction [5], Alertness [5/level], Animal Empathy [5], Cultural Adaptability [25], Disease-Resistant [5], Language Talent [2/level], Military Rank [5/level], Patron [Varies], Wealth [Varies], or upgrade Fit to Very Fit [+10 points].

**Disadvantages:** A total of -10 points from Delusion [Varies]; Duty [Varies]; Jealousy [-10]; Loner [-5]; or Overconfidence [-10].



**Primary Skills:** Survival (M/A) IQ+3 [8]-14; and either Cartography (M/A) IQ+2 [6]-13 or Navigation (M/H) IQ+1 [6]-12.

**Secondary Skills:** One of Merchant or Prospecting (M/A) IQ+2 [6]-13; Anthropology, Archeology, Intelligence Analysis, Naturalist, or Strategy (M/H) IQ+1 [6]-12; or Linguistics (M/VH) IQ [6]-11; one of Administration, Leadership (M/A) IQ+1 [4]-12 or Diplomacy (M/H) IQ [4]-11; and 2 points in appropriate Language skills.

**Background Skills:** Area Knowledge (M/E) IQ [1]-11; and a total of 3 points in Black Powder Weapons or Guns (P/E); Cooking, First Aid, Gesture, or Scrounging (M/E); or Boating, Climbing, Lasso, or Riding (P/A).

**Customization Notes:** In a TL(5+1) campaign with space travel, add Planetology or Xenobiology (M/A) IQ+2 [6]-13, and Xenology (M/H) IQ+1 [6]-12 to the choices for Secondary Skills.

## INVENTOR

## 90 POINTS

You are a master of advanced technology and the scientific principles underlying it. You may have already created one or more devices, or you may be starving in an attic while you perfect your invention.

**Attributes:** ST 10 [0]; DX 10 [0]; IQ 15 [60]; HT 10 [0].

**Advantages:** A total of 25 points from Acute Vision [2/level]; Gadgeteer [25]; High Technology +1 TL [20]; Independent Income (Royalties from patents) [5]; Intuition [15]; Invention [Varies]; Lightning Calculator [5]; Manual Dexterity [3/level]; Mathematical Ability [10]; Military Rank [5/level]; Patron (Industrial firm) [Varies]; Single-Minded [5]; Versatile [5]; or +1 to IQ [20].

**Disadvantages:** A total of -20 points from Absent-Mindedness [-15]; Curious [Varies]; Jealousy [-10]; Obsession [Varies]; Poverty [Varies]; or Workaholic [-5].

**Primary Skills:** One of Armoury (M/A) IQ+6 [14]-21; Chemistry; Computer Programming; Engineer; Metallurgy; or Shipbuilding (M/H) IQ+5 [14]-20.

**Secondary Skills:** Research (M/A) IQ-1 [1]-14; and two of Blacksmith (M/A) IQ-3 [2]-12\*; Mechanic or Traps (M/A) IQ [2]-15; Glassblowing (P/H) DX-1 [2]-9; or Computer Programming, Geology, Pharmacy, or Poisons (M/H) IQ-1 [2]-14.

\* Reflects a -3 modifier for ST 10.





**Background Skills:** Two of Artificial Intelligence, Astronomy, Chemistry, Cryptology, Geology, Mathematics, or Physics (M/H) IQ-1 [2]-14; or two of Biochemistry, Etheric Science, or Physiology (M/VH) IQ-2 [2]-13. Two of Beam Weapons or Guns (P/E) DX+2 [1]-12\*; Scrounging (M/E) IQ [1]-15, Battlesuit, Driving, Exoskeleton, Free Fall, Piloting, or Powerboat (P/A) DX-1 [1]-9; Administration, Demolition, Hard-Hat Diving, Open-Dress Diving, Teaching, or Vacc Suit (M/A) IQ-1 [1]-14; Poisons or Shiphandling (M/H) IQ-2 [1]-13; or Law (Patents) (M/H) IQ-2 [1]-12/18.

\* Reflects the +2 bonus from IQ 12+.

**Customization Notes:** A variant on this archetype is the medical or biological innovator. Appropriate skills include Biochemistry, Chemistry, Pharmacy, Physician, Physiology, Surgery, Veterinary, and possibly Botany, Genetics, Paleontology, and Geology. A cinematic inventor may have Gadgeteer [50].

## MEDIUM 60 POINTS/55 POINTS

The practice of spiritualism began in the 19th century and was almost immediately controversial. Believers regarded it as proof of survival after death; skeptics considered it fraudulent. Two corresponding templates are presented here: a clever hoaxer and a true psychic. The latter should only be used in a campaign where psychic powers are real – but remember that a world with real psychics will still have fakes. Both kinds are likely to be young when they start their careers.

Use the following 60-point template for a fraudulent medium:

**Attributes:** ST 10 [0]; DX 13 [30]; IQ 11 [10]; HT 10 [0].

**Advantages:** Sanctity [5]; and a total of 15 points from Ambidexterity [10], Charisma [5/level], Double-Jointed [5], Empathy [15], Manual Dexterity [3/level], Night Vision [10], Religious Rank [5/level], or Voice [10]. You may also have the ability to use your feet as extra “hands”: Extra Arms x2 (“legless” when in use, -35%; clumsy and lack opposable thumbs, -40%) [5], as defined for Houdini in *GURPS Who's Who 2* (p. WWi100).

**Disadvantages:** Secret [-5]; and a total of -15 points from Delusions (Really in touch with mystical powers) [Varies], Enemies (Skeptics or criminal investigators) [Varies], Greed [-15], additional levels of Secret [Varies], or Youth [Varies].

**Primary Skills:** Fortune Telling (M/A) IQ+3 [8]-14.

**Secondary Skills:** Two of Stealth (P/A) DX+1 [4]-14, Acting, Holdout, Lockpicking, or Occultism (M/A) IQ+1 [4]-12; Escape or Sleight of Hand (P/H) DX [4]-13; Mimicry (Human Speech) (P/H; HT) HT [4]-10; or Ventriloquism (M/H) IQ [4]-11.

**Background Skills:** A total of 4 points chosen from Bard (M/A); Hypnotism (M/H); Performance/Ritual (M/A); Psychology (M/H); Research (M/A); Savoir-Faire (M/E); or Theology (M/H).

**Customization Notes:** A fake medium might also depend on technical wizardry to create supernatural effects. This might be provided by an assistant, or the medium might have technical skills, possibly even at the “crazed inventor” level.

Use the following 55-point template for a medium with genuine psychic gifts:

**Attributes:** ST 10 [0]; DX 10 [0]; IQ 13 [30]; HT 10 [0].

**Advantages:** Either Channeling or Medium with Preparation Required (One hour) [5]; and 15 points chosen from Autotrance [5 points], Charisma [5/level], Clerical Investment [5/level], Empathy [15], Intuition [15], Spirit Empathy [10], or Strong Will [4/level].

**Disadvantages:** A total of -15 points from Absent-Mindedness [-15]; Disciplines of Faith [Varies]; Low Pain Threshold [-10]; Nightmares [-5]; Pacifism (Cannot kill) [-15]; Split Personality [-15]; Unfit [-5]; Weirdness Magnet [-15]; Xenophilia [Varies]; Youth [Varies]; or -1 HT [-10]. The Split Personality disadvantage should be interpreted as periodically being taken over by a spirit – in effect, involuntary Channeling.



**Primary Skills:** Performance/Ritual (Spiritualist) (M/A) IQ+1 [4]-14; and one of Diplomacy (M/H) IQ [4]-13, Exorcism (M/H) IQ [4]-13, or Lucid Dreaming (M/E) IQ+2 [4]-15.

**Secondary Skills:** Savoir-Faire (M/E) IQ+1 [2]-14; and two of Hidden Lore (Spirits) or Occultism (M/A) IQ [2]-13; Anthropology, Philosophy, Psychology, Thanatology, or Theology (M/H) IQ-1 [2]-12; or Psionics (M/VH) IQ-2 [2]-11.

**Background Skills:** A total of 6 points in Area Knowledge (Astral Plane) (M/E); Bard or Criminology (M/A); or Detect Lies, Hypnotism, or Psychology (M/H).

**Customization Notes:** In a campaign where the spectral undead are psionic entities, levels of Astral Projection [3/level] may be substituted for Channeling/Medium and any other of these advantages, and mediums may also have the powers of Metabolism Control [1/level], Clairvoyance [2/level], Healing [3/level], or Telepathy [10/level]. Astral Projection (M/H) IQ+1 [4]-14 should replace the other primary skill options.

## NATIVE LEADER 80 POINTS

When the Europeans came to your land, you saw the threat they posed to your people. It may be too late to do anything about them, but you're determined to try, and you've found warriors willing to follow you. In a country without a standing army, it takes exceptional personal qualities to attain such leadership, and you have them.

**Attributes:** ST 11 [10]; DX 11 [10]; IQ 13 [30]; HT 11 [10].

**Advantages:** Charisma +1 [5]; Combat Reflexes [15]; and an additional 10 points chosen from Alertness [5/level], Ally [Varies], additional Charisma [5/level], Comfortable [10], Fearlessness [2/level], Religious Rank [5/level], Sensitive [5], Status [5/level], Strong Will [4/level], and Voice [10].

**Disadvantages:** Illiteracy [-10]; Primitive (-3 TLs) [-15]; and Sense of Duty (Your nation) [-10].

**Primary Skills:** Bard or Leadership (M/A) IQ+4 [10]-17.

**Secondary Skills:** One of Boating (P/A) DX+1 [4]-12, Hiking (P/A; HT) HT+1 [4]-12, or Riding (P/A) DX+1 [4]-12; two of Savoir-Faire (M/E) IQ+1 [2]-14, Intimidation or Politics (M/A) IQ [2]-13, Bard or Leadership (M/A) IQ [2]-13, or Diplomacy or Law (M/H) IQ-1 [2]-12; and two of Black Powder Weapons (P/E) DX+3 [2]-14, Knife, Shield, or Speed-Load (Black Powder Weapons) (P/E) DX+1 [2]-12, Broadsword, Shortsword, Spear, or Stealth (P/A) DX [2]-11, Bow (P/H) DX-1 [2]-10, or Tactics (M/H) IQ-1 [2]-12.

**Background Skills:** Survival (M/A) IQ-1 [1]-12; and 2 points in Swimming (P/E); Camouflage or Fishing (M/E); Stealth (P/A); Agronomy, Animal Guise, Armoury, Prospecting, Tracking, or Traps (M/A); Mimicry (P/H; HT); or Animal Handling, Bardic Lore, Naturalist, or Rituals and Ceremonies (M/H).

**Customization Notes:** This template could be adapted to describe the leader of a colonial rebellion. British troops faced many such opponents in the American War of Independence (a bit before this period) and the Boer War. Such a character would not be Primitive and usually would not have Illiteracy; select other disadvantages.



## RECKONER 65 POINTS

You belong to one of the newest professions of the Steam Age: the men (and women) who create instructions for analytical engines. Your work requires a sophisticated grasp of mathematical relationships, and willingness to get your hands dirty rearranging gears or circuits. This option is only available in a TL(5+1) campaign that has analytical engines.

**Attributes:** ST 10 [0]; DX 10 [0]; IQ 14 [45]; HT 10 [0].

**Advantages:** Manual Dexterity +1 [3]; and an additional 15 points from Administrative Rank [5/level], Double-Jointed [5], Machine Empathy (15), Mathematical Ability [10], Military Rank [5/level], Patron [Varies], Single-Minded [5], Versatile [5], +1 IQ [15], or additional Manual Dexterity [3/level].

**Disadvantages:** A total of -15 points in Absent-Mindedness [-15]; Bad Sight (Nearsighted) [-10]; Curious [Varies]; Hard of Hearing [-10]; No Sense of Humor [-10]; Odious Personal Habit (Grease-stained) [-5]; Shyness [Varies]; or Workaholic [-5].

**Primary Skills:** Computer Programming (M/H) IQ+1 [6]-15.

**Secondary Skills:** Mechanic (Electrician or Precision Machinery) (M/A) IQ-1 [1]-13; and an additional 5 points in Accounting, Astronomy, Cryptanalysis, Cryptography, Cryptology, Engineer, Mathematics, Musical Composition, Physics, Economics, Strategy, or Tactics (M/H). In a campaign with sentient engines, Artificial Intelligence (M/H) is also appropriate.

**Background Skills:** A total of 5 points in Chess, Musical Notation, or Telegraphy (M/E); Administration, Cartography, Forward Observer, Research, Streetwise, or Teaching (M/A); or Musical Instrument (M/H).

**Customization Notes:** Choose secondary and background skills to fit the reckoner's specialty. A military field officer who wires in artillery computations for the army might want Cryptography-12 [1], Forward Observer-15 [4], Tactics-14 [4], and Telegraphy-14 [1], while a civil servant who works with tax data would be more likely to have Accounting-14 [4], Administration-15 [4], Economics-12 [1], and Research-13 [1]. In high-powered campaigns, Eidetic Memory [30 or 60] and Intuitive Mathematician [25] are appropriate additions to this template.

## REFORMER 70 POINTS

Your goal is to improve society and the lives of your fellow men. Reformers pursue this goal through a variety of means; several specializations are offered to reflect this diversity. All of them, however, emphasize social and intellectual rather than physical skills.

**Attributes:** ST 10 [0]; DX 10 [0]; IQ 13 [30]; HT 11 [10].

**Advantages:** Charisma +1 [5]; and 20 additional points from Administrative Rank [5/level], Composed [5], Empathy [15] or Sensitive [5], Independent Income [5], Less Sleep [3/level], Religious Rank [5/level], Single-Minded [5], Status [5/level], Voice [10], Wealth [Varies], or additional Charisma [5/level].

**Disadvantages:** Sense of Duty [-10]; and -10 additional points from Bad Sight [-10], Delusions [-5], Enemy [Varies], No Sense of Humor [-10], Obsession [Varies], Odious Personal Habits (Lecturing others) [-5], Overconfidence [-10], Poverty [Varies], Secret [Varies], Skinny [-5], Social Stigma [Varies], Status [-5/level], Workaholic [-5], -1 ST, DX, or HT [-10], or increased Sense of Duty [Varies].

**Primary Skills:** Administration (M/A) IQ+1 [4]-14; Bard (M/A) IQ+1 [2]-14; and one of the following options:

**Politician:** Law (M/H) IQ-1 [2]-12; and Politics (M/A) IQ+1 [6]-15;

**Revolutionary:** Acting (M/A) IQ+1 [4]-14; Holdout (M/A) IQ-1 [1]-12; Intelligence Analysis (M/H) IQ-1 [2]-12; and Shadowing (M/A) IQ-1 [1]-12;

**Social Worker:** Area Knowledge (M/E) IQ+1 [2]-14; and Psychology (M/H) IQ+1 [6]-14.

**Secondary Skills:** Research (M/A) IQ [2]-13; and two of Criminology (M/A) IQ [2]-13; Economics, Epidemiology, History, Law, Philosophy, Physician, Psychology, or Theology (M/H) IQ-1 [2]-12; or Conspiracy Theory (M/VH) IQ-2 [2]-11.

**Background Skills:** One of Teaching or Writing (M/A) IQ-1 [1]-12; and a total of 4 points in Typing (P/E); Cooking, First Aid, Savoir-Faire, or Scrounging (M/E); Architecture, Disguise, Fast-Talk, or Leadership (M/A); or Detect Lies or Diplomacy (M/H).

**Customization Notes:** Both Fanaticism and Pacifism are suitable higher-point-value disadvantages.



## REPORTER 60 POINTS

You work for a newspaper, writing accounts of noteworthy events – or creating them yourself. Especially on small papers, this is a stressful job with long hours, but it's seldom dull. You might end up as the editor of a great metropolitan newspaper, or even as a famous writer.

**Attributes:** ST 10 [0]; DX 10 [0]; IQ 12 [20]; HT 12 [20].

**Advantages:** A total of 15 points from Alcohol Tolerance [5], Alertness [5/level], Charisma [5/level], Intuition [15], Patron [Varies]; and Composed [5], Fearlessness [2/level], or Unfazeable [15].

**Disadvantages:** Code of Honor (Newsmen: get the story in) [-5]; and -15 additional points from Alcoholism [-15], Callous [-6], Compulsive Carousing [-5], Curious [Varies], Duty [Varies], Enemies [Varies], Jealousy [-10], Odious Personal Habit (Aggressive questions) [-5], Overconfidence [-10], Struggling [-10], or Workaholic [-5].

**Primary Skills:** Area Knowledge (M/E) IQ+2 [4]-14 and Writing (M/A) IQ+2 [6]-14.

**Secondary Skills:** Research (M/A) IQ [2]-12; one of Artist (M/H) IQ-1 [2]-11, Calligraphy (P/A) DX [2]-10, Photography (M/A) IQ [2]-12, Telegraphy (M/E) IQ+1 [2]-13, or Typing (P/E) DX+1 [2]-11; one of Savoir-Faire (M/E) IQ+1 [2]-13 or Streetwise (M/A) IQ [2]-12; and one of Sports (P/A) DX [2]-10, Criminology or Politics (M/A) IQ [2]-12 or Accounting, Law, Economics, or Strategy (M/H) IQ-1 [2]-11.

**Background Skills:** Carousing (P/A: HT) HT [2]-12; and 5 additional points in Brawling or Guns (P/E); Driving or Riding (P/A); Acting, Bard, Disguise, Fast-Talk, Holdout, Poetry, or Shadowing (M/A); or Detect Lies, Diplomacy, Forgery, or History (M/H).

---

There had, for instance, been no printed news-sheet in Illinois for twenty-seven years. Chicago argued that engines for printed news sooner or later developed into engines for invasion of privacy, which in turn might bring the old terror of Crowds and blackmail back to the Planet.

– Rudyard Kipling,  
"As Easy as A.B.C."

---

**Customization Notes:** Select an Area Knowledge skill which matches the reporter's "beat": a neighborhood, a city, or an entire nation. There are many popular reporter stereotypes, and suitable choices let this template be used for any of them: e.g., Big-Shot Editor (Charisma; Overconfidence and Workaholic; and Bard, Diplomacy, Politics, and Savoir-Faire), Hard-Boiled Stringer (Alcohol Tolerance; Alcoholism, Compulsive Carousing, or Struggling; and Brawling, Criminology, Fast-Talk, and Streetwise), and War Correspondent (Unfazeable; Callous and Overconfidence; and Guns, History, Savoir-Faire (Military), and Strategy).

## SCIENTIST

70 POINTS

The role of scientist is new; the word wasn't coined until 1840. Scientists are knowledgeable in one or more branches of the study of nature; there is little specialization yet. Scientists are often amateurs supported by inherited wealth or doing research in their spare time; neither government nor industry offers large research budgets in the English-speaking world, though Germany is more generous.



**Attributes:** ST 10 [0]; DX 10 [0]; IQ 14 [45]; HT 10 [0].

**Advantages:** A total of 15 points from Alertness [5/level]; Collected [5]; Comfortable [10]; High Technology [Varies]; Higher Purpose [5]; Independent Income [5]; Intuition [15]; Manual Dexterity [3/level]; Mathematical Ability [10]; Single-Minded [5]; Status [5/level]; Tenure [5]; or +1 IQ [15].

**Disadvantages:** A total of -15 points from Absent-Mindedness [-15]; Age [-3/year over 50]; Bad Sight (Nearsighted) [-10]; Callous [-6]; Code of Honor (Professional) [-5]; Combat Paralysis [-15]; Delusions [-5]; Fanaticism [-15]; Jealousy [-10]; Low Empathy [-15]; Obsession (Research project) [Varies]; Poverty [Varies]; Shyness [Varies]; Skinny [-5]; Truthfulness [-5]; or Workaholic [-5].



**Primary Skills:** Research (M/A) IQ+1 [4]-15; and one of Astronomy, Botany, Chemistry, Geology, Naturalist, Physician, Physics, Paleontology, Psychology, or Zoology (M/H) IQ+2 [8]-16; or Biochemistry, Etheric Science, Physiology, or Psionics (M/VH) IQ [8]-14.

**Secondary Skills:** One of Bard, Teaching, or Writing (M/A) IQ-1 [1]-13; and a total of 6 points in Astronomy, Botany, Chemistry, Geology, Mathematics, Naturalist, Physician, Physics, Paleontology, Psychology, or Zoology (M/H).

**Background Skills:** Language (English, French, German, or Latin) (M/A) IQ-1 [1]-13; and a total of 5 points in Savoir-Faire (M/E); Administration, Mechanic, Photography or Survival (M/A); Glassblowing (P/H); or Animal Handling, Artist, Computer Programming, Engineering, Metallurgy, Physician, Poisons, or Veterinary (M/H).

**Customization Notes:** A cinematic scientist may have Intuitive Mathematician [25] rather than Mathematical Ability [10]. Consider the *Science!* skill as well.

## SERVANT 40 POINTS

In many households you're the one who really keeps things going. The aristocracy and the respectable middle classes depend on you for your practical skills and as the proof of their respectability. For all that, your life isn't easy, especially if your master or mistress can only afford one or two servants for the many tasks of a household without electrical appliances.

**Attributes:** ST 10 [0]; DX 10 [0]; IQ 10 [0]; HT 12 [20].

**Advantages:** A total of 15 points chosen from Acute Taste and Smell [2/level]; Alertness [5/level]; Ally [Varies]; Animal Empathy [5]; Less Sleep [3/level]; Manual Dexterity [3/level]; Military Rank 0 [0]; Patron [Varies]; or Versatile [5]; and Composed [5] or Unfazeable [15].

**Disadvantages:** Duty (12 or less, nonhazardous) [-5]; Status -1 [-5]; and -10 points chosen from Illiteracy [-10], Laziness [-10], Poverty (Struggling) [-10], Semi-Literacy [-5], Sense of Duty (Employer and family) [-5], Shyness [Varies], Skinny [-5], Truthfulness [-5], or Workaholic [-5].

**Primary Skills:** Savoir-Faire (Servant) (M/E) IQ+2 [4]-12 and any of the following specializations:

**Batman:** Cooking (M/E) IQ [1]-10; First Aid (M/E) IQ [1]-10; Savoir-Faire (Military) (M/E) IQ+2 [4]-12; and Scrounging (M/E) IQ+1 [2]-11;

**Butler:** Administration (M/A) IQ [2]-10; Bartender (M/A) IQ [2]-10; Merchant (M/A) IQ [2]-10; and increase Savoir-Faire (Servant) to 13 [2];

**Chauffeur:** Driving (P/A) DX+1 [4]-11; and Mechanic (M/A) IQ+1 [4]-11;

**Coachman:** Animal Handling (Horses) (M/H) IQ-1 [2]-8/14; and Teamster (M/A) IQ+2 [6]-12;

**Cook:** Beverage-Making (M/E) IQ+2 [4]-12; and Cooking (M/E) IQ+2 [4]-12;

**Maid:** Flower Arranging (M/E) IQ [1]-10; Needlecraft (P/A) DX-1 [1]-9; Professional Skill: Housekeeping (M/A) IQ+1 [4]-11; and Stealth (P/A) DX [2]-10;

**Nurse:** Diagnosis (M/H) IQ-2 [1]-8; Fast-Talk (M/A) IQ [2]-10; First Aid (M/E) IQ [1]-10; Profession (Child Care) (M/A) IQ [2]-10; Singing (P/E; HT) HT [1]-12; and Teaching (M/A) IQ [1]-9.

**Secondary Skills:** One of Acting or Fast-Talk (M/A) IQ+2 [6]-12; or Diplomacy (M/H) IQ+1 [6]-11.

**Background Skills:** A total of 7 points chosen from Bicycling (P/E) DX+1 [2]-11; Area Knowledge (local community), First Aid, Savoir-Faire, or Scrounging (M/E) IQ+1 [2]-11; Riding or Stealth (P/A) DX [2]-10; Carousing (P/A; HT) HT [2]-12; Administration or Language (French) (M/A) IQ [2]-10; or Sex Appeal (M/A; HT) HT [2]-12.

**Customization Notes:** A cinematic butler or "gentleman's gentleman" should be built on substantially more points, with at least IQ 12 [20] and commensurate increases in skills. Servants of this type often have amazingly diverse skills with which to assist their masters or get them out of trouble. The head servant from a wealthy household may have Status 0.

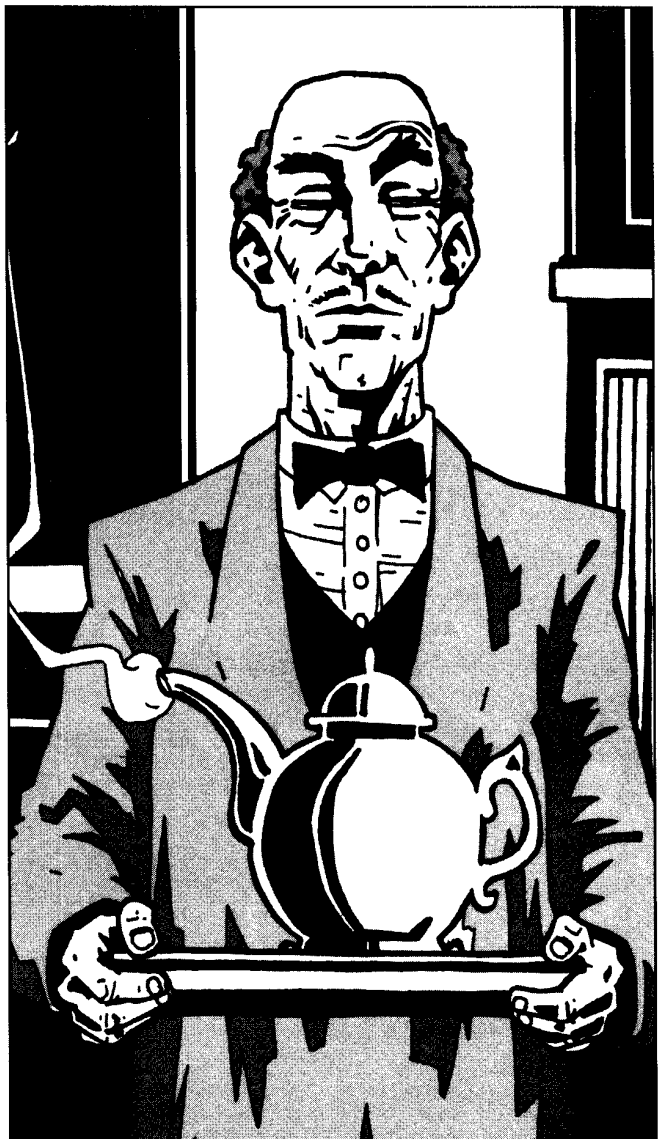

## SPORTSMAN

## 75 POINTS

You may be an amateur or a professional; in either case, athletic achievement is the focus of your life. You spend considerable effort on keeping fit and practicing the sport(s) you enjoy. This template includes a variety of options, including packages of skills to cover unusual choices such as hunting, mountain climbing, and rodeo.

**Attributes:** ST 11 [10]; DX 11 [10]; IQ 10 [0]; HT 12 [20].

**Advantages:** A total of 20 points chosen from Ambidexterity [10]; Attractiveness [Varies]; Breath-Holding [2/level]; Charisma [5/level]; Comfortable [10]; Extra Fatigue [3/level]; Fit or Very Fit [5 or 15]; High Pain Threshold [10]; or +1 [10] or +2 [20] to DX or ST.

**Disadvantages:** A total of -20 points chosen from Appearance [Varies]; Bad Temper [-10]; Bully [-10]; Code of Honor [Varies]; Compulsive Behavior (Exercise) [-5]; Glory Hound [-15]; Impulsiveness [-10]; Overconfidence [-10]; Sense of Duty (Teammates) [-5]; or -1 IQ [-10].



**Primary Skills:** One of the following skills or skill packages: Bicycling, Guns Sport (Pistol or Rifle), or Swimming (P/E) DX+4 [16]-15; Boating, Boxing Sport, Fencing Sport, Riding, Sports, or Wrestling Sport (P/A) DX+3 [16]-14; Bow Sport, Skating, or Throwing (P/H) DX+2 [16]-13; Lifting (PH; ST) ST+2 [16]-13; Running (PH; HT) HT+2 [16]-14; Acrobatics (P/H) DX+1 [8]-12 and Jumping (P/E) DX+3 [8]-14; Boating (P/A) DX+2 [8]-13 and Fishing (M/E) IQ+4 [8]-14; Climbing (P/A) DX+2 [8]-13 and Survival (Mountains) (M/A) IQ+3 [8]-13; Equestrian Acrobatics (P/H) DX+1 [8]-12, Lasso (P/A) DX+1 [4]-12, and Riding (P/A) DX+1 [4]-12; or Guns (Rifle) (P/E) DX+4 [8]-15, Stealth (P/A) DX+1 [4]-12, and Tracking (M/A) IQ+1 [4]-11.

**Secondary Skills:** Tournament Law (M/E) IQ+2 [4]-12; and any two of Brawling (P/E) DX+2 [4]-13; First Aid (M/E) IQ+2 [4]-12; Intimidation, Leadership, or Teaching (M/A) IQ+1 [4]-11; or Naturalist (M/H) IQ [4]-10.

**Background Skills:** A total of 7 points chosen from Bicycling, Jumping, or Swimming (P/E); Boating, Climbing, Dancing, or Riding (P/A); Acrobatics or Throwing (P/H); Lifting (PH; ST); Running (PH; HT); Animal Handling (M/H); or maneuvers appropriate to a specific sport.

**Customization Notes:** The sportsman should pick secondary and background skills which mesh with the pursuit suggested by his primary skills; e.g., Brawling and Intimidation are better matches for Boxing Sport or Sports (Rugby) than for Bow Sport or Riding. In a 100-point game, 25 points will be left over after purchasing this template; another 25 points can be gained from additional disadvantages and quirks. It is reasonable for a career athlete to spend all 50 points on more ST, DX, and HT. Physical attributes of 14 to 16 – and the attendant lack of skills outside of sports pursuits – are in keeping with the character type.

---

He had now achieved a very striking control of his muscles. There was no more learning of skilled movements. His limbs, nay the individual muscles themselves, did precisely as he willed.

– Olaf Stapledon,  
*Odd John*

---

# SOCIAL POSITION

Several types of Rank exist in the Age of Steam: Administrative, Military, and Religious, nearly everywhere; Academic in Germany and countries influenced by its university system; Corporate in large businesses (roughly comparable to Merchant). Military Rank, Administrative Rank in a government, and Religious Rank in an established or generally accepted church give a bonus to Status (+1 per three levels of Rank, rounded off). Rank in other organizations generally does not. Courtesy Rank exists in various forms (1 point/level) but never confers Status.

Administrative Rank in republics goes as high as level 8 (head of state); in societies where the head of state is a hereditary ruler or religious figure, Administrative Rank only reaches level 7 (head of government). Military Rank always goes as high as level 8 (see p. B22 and Chapter 4, p. 55 and 59). Religious Rank is much more varied. The Pope has Religious Rank 8; Joseph Smith had Religious Rank 8 during his life, but his successors, the Presidents of the Church of Jesus Christ of Latter-Day Saints, only have Religious Rank 7. Patriarchs of the Orthodox churches have Religious Rank 7, as do heads of national churches. However, the head of the Church of England is the Queen, who does not have Religious Rank apart from her Social Status, while the Archbishops of Canterbury and York have Religious Rank 6. At the other extreme, American Baptist churches typically have only two ranks, deacon or elder (Religious Rank 1) and ordained minister (Religious Rank 2), and congregations of Friends may have none.

The highest Status is 7 for a reigning monarch (except "divine" monarchs such as the Japanese emperor or the Mahdi, who are Status 8); Napoleon was Europe's last Status 8 ruler. The head of state in a republic is Status 6 (with three levels free from Administrative Rank). The lowest Status is -3 for a beggar or someone confined to a lunatic asylum, prison, or workhouse; someone who can at least simulate working for a living is Status -2.

*Social Stigma* means belonging to an identifiable subgroup whose members are treated with less respect than others of their class. It's possible to have both Social Stigma and high Status. For example, Queen Victoria has Status 7 and Social Stigma (Second-Class Citizen), for a net reaction modifier of +6 and a net cost of 30 points. She is treated with great respect, but slightly less than a reigning *king* would receive.

A known criminal has a negative Reputation. An ethnic population that includes many criminals, or is *believed* to do so, such as the Gypsies, may have Social Stigma (minority group); even law-abiding members of such a population will be immediate suspects in any crime, unless they have a compensatory positive Reputation. Not having a regular source of income is good for Status -2 or -3 – but a fence who ran a pawnshop would have Status 0 as a tradesman.

Player characters are free to set aside these modifiers in dealing with each other, unless they have Intolerance of other social classes. But crossing the lines too freely can earn a negative Reputation: "doesn't know his place" or "associates with riffraff."

## WOMEN AS ADVENTURERS

Women in the Age of Steam had limited legal rights and few career options; these restrictions can be represented as Social Stigma (Second-Class Citizen) [-5]. Most men expected women to be physically and mentally helpless and need male protection. The only career open to most women was that of wife and mother, a role not easily combined with having adventures.

But none of this absolutely prevents women from having adventures. Any of a variety of explanations can be used for a woman's being in an unusual role:

Her husband may have unusual views on marriage and the role of women; such "advanced" ideas began to find advocates in this era. (He may be an Ally.)

She may be widowed and carrying on her husband's work.

She may be unmarried and have an independent income that lets her pursue her own interests, whether doing good works as a nurse or philanthropist, or studying a traditionally masculine subject such as medicine. (She may have an Independent Income.)

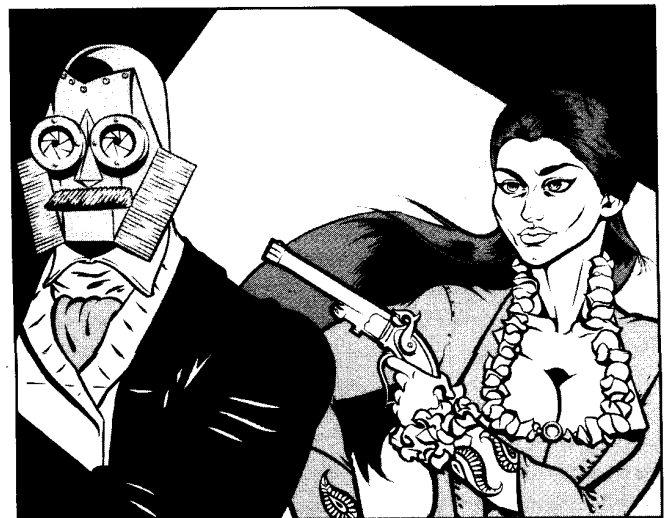

She may be from the lower social classes – for example, one of the factory girls whose new independence worried many traditionalists. (She will have Status -1 or -2.)

She may be an actress, adventuress, demimondaine, or other figure of scandal. Social Stigma (minority group) is appropriate.

She may be able to disguise herself as a man, even in the army or navy; there are many accounts of women who did so. (This is a Secret.)

Remember that adventurers and innovators are unusual people almost by definition; a woman with the talents, skills, and motivation to become one isn't likely to be stopped by the relatively weak restraints of 19th-century law and custom upon her sex, though they may be the basis for dramatic conflicts and interesting characterization. Women are no longer treated as valuable property but as people, albeit not as equals to men.

# ADVANTAGES, DISADVANTAGES, AND SKILLS

## ADVANTAGES

### **Multimillionaire** *see p. C127*

Being a Multimillionaire, as such, does not grant additional Status. There is new money and there is old money. "The sort of people who buy their silver" is an expression of contempt.

### **Patron** *see pp. B24-25*

In the Age of Steam, even national governments are comparatively small, especially in the English-speaking world. A national government is a Patron with base cost 25 points, equivalent to a very large business firm (such as a railroad) or a very wealthy one (such as the Rothschilds); it does not have effectively unlimited assets. Most business firms are 15-point Patrons.

### **Strong Will** *see p. B23*

This advantage is very much in the 19th-century idiom.

## NEW ADVANTAGES

### **Independent Income** *5 points*

You have what nearly everyone in the Age of Steam wants: a source of income that does not require you to work. The source of income is up to you: a trust fund, a pension, rent on land or houses, royalties on inventions – use your imagination! Income per month is 5% of the starting wealth for your wealth level. At the GM's discretion, you may need to spend 10 hours a month looking after financial matters – doing anything from standing in line at a pension office to reading reports from trustees. This advantage only applies to those who normally *would* work for a living, i.e., from Poor to Wealthy. If you are Very Wealthy or better you already have it, and the same 5% of starting wealth per month can be used to determine your income; if you are Dead Broke you have no income.

This advantage can be used to represent military pensions and half pay: Kipling's "shillin' a day – bloomin' good pay!" (an old sergeant's pension) amounts to Poor with Independent Income, while an inactive officer's half pay is Comfortable with Independent Income.

If your income derives from investments, their exact value need not be specified; it is assumed that you cannot or will not invade your capital.

### **Invention** *Variable*

This is a specialized form of Unusual Background, designed to let characters start play with one or more advanced devices without making character design more complex. There are three versions, each with a point cost and

prerequisite. A 5-point invention is a novel application of TL5 knowledge (or TL(5+1) knowledge that is already established in the campaign setting), such as the use of ether for surgical anesthesia; its prerequisite is possession of a relevant scientific skill at 15 or better. A 15-point invention is a new TL(5+1) device or process, such as the analytical engine; its prerequisite is skill 20 or better. A 50-point invention is a radical discovery, such as time travel or the reanimation of corpses; its prerequisite is skill 25 or better. Any invention requires the permission of the GM.

No monetary cost need be paid for the invention; instead, describe how the inventor spent an inheritance on it, scrounged the parts from junkyards, built them in a basement workshop, synthesized a rare ingredient, or the like. The device cannot be sold for any substantial amount of money. It is assumed to be a prototype, not readily copied and thus not licensable.

The inventor need not be a Gadgeteer. The differences are discussed in Chapter 5 (see p. 68).



## Machine Empathy

15 points

You have a natural feel for machines. If a machine is having problems, you have +2 to figure them out and correct them for an unfamiliar machine, +4 for a familiar machine. You also have +2 to reactions and social skills for dealing with sentient machines. You can use machines – that's what they're made for – but you find it unpleasant to see machines or tools used carelessly or destructively and should prevent others from doing so.

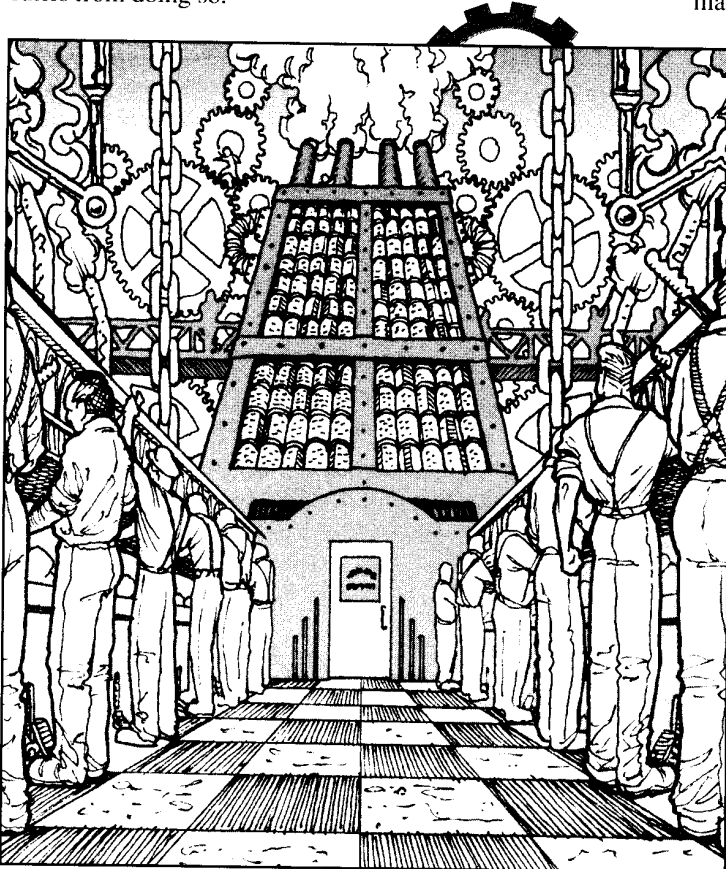

## DISADVANTAGES

### Addiction

see p. B30

In the civilized world, drug use is not subject to legal penalties; the value of any addiction is thus 5 points lower than in the 20th century. Many drugs are also cheap, since they do not have to be bought on the black market. For example, laudanum (an alcohol solution of opium) is cheap, highly addictive, and legal, and is thus a -5 point addiction.

### Code of Honor

see p. B31

The gentleman's Code of Honor is widespread in the Age of Steam; any male character of Status 3 or higher should have it, or have a negative Reputation or a Secret. (See the *Flashman* novels by George Macdonald Fraser for an example of such a Secret.)

## CHARACTERS

## Delusion (Genteel Proficiency) -15 points

This delusion could also be called "Blood Will Tell." It reflects the belief that an untrained combatant of good breeding can defeat a trained combatant from the lower classes. You begin play with combat skills no higher than DX and with Strategy and Tactics no higher than IQ; all such skills have double cost. You can raise skills normally during play, but you must make a Will-2 roll to accept formal instruction (informal instruction, as from a ruffian, is never acceptable). Note that military officers sometimes had this delusion! Unlike most Delusions, this one does not give any reaction penalty.

## Lecherousness

see p. B34

This is certainly a possible disadvantage for people in the Age of Steam; history records some impressive examples. But its expression requires some subtlety. A man who takes the direct approach risks a duel, a fist fight, or horsewhipping; a woman faces subtler but more lasting penalties. If you fail a Will roll against Lecherousness you should begin scheming to be alone with the object of your passion; once you manage this you can press the matter further.

## Sense of Duty

see p. B39

Victorian women usually do not have adventures; they stay at home with their families while their husbands fight wars or explore remote lands. Thus, it is often inappropriate to treat a family as Dependents. However, both men and women are likely to have a Sense of Duty to their families (-5 points). This may be subsumed under Sense of Duty to one's country; the point value should be based on which Sense of Duty takes precedence in a crisis.

## Vow (Parole)

-10 points

A military man who is captured alive by the enemy may be offered the chance to give his parole. This is a promise to refrain from combat against the enemy, from actively supporting other combatants, and from attempting to escape. The captive benefits from avoiding the more unpleasant aspects of imprisonment; the captors benefit from not having to pay for guards or prison walls to keep him imprisoned. Parole is taken seriously and can be treated as a Vow. Usually this disadvantage will be acquired during play.

## NEW DISADVANTAGES

### Rote Learning

-25 points

This is a slightly less restrictive form of Cannot Learn (p. C186). Someone with Rote Learning cannot spend character points to improve IQ, DX, or skills. However, he can learn new maneuvers by drill and memorization, buying them up from the prerequisite skill; or he can practice a maneuver and increase his ability in it.



*Example:* You are a mechanical musician, with the skill of Musical Instrument (Piano)-14. If you have to play a new piece, you must make a skill roll at -2 to sight-read it. However, with practice, you will gain improved facility: 100 hours of practice counts as 1/2 point, multiplied by 4 due to Eidetic Memory 2 to give an effective 2 points, which allows a +2 bonus for a hard maneuver, or skill 14.

## TL5 SKILLS

The skills in this list are based on the real 19th century. Skills based on more advanced steam technology appear on the facing page. Universes with different natural laws (see *Weird Science*, pp. 94-108) may develop some skills early or may have entirely new skills.

### **Area Knowledge** *see pp. B62-63*

In campaigns where psychic powers exist, one possible specialization for Area Knowledge is the Astral Plane.

### **Black Powder Weapons** *see p. B49 and p. C1120*

This applies to firearms up through the introduction of cartridges and to older models for the rest of the period. Caplock models are standard, though a few archaic flintlocks may still be around.

### **Computer Operation** *see p. B58*

Computers built with 19th-century technology do not have terminals or interface programs; thus, there is no skill of Computer Operation.

### **Computer Programming** *see p. B60*

Computers built at TL5 have the Dedicated option; their "programs" are built in when they are constructed. There is thus no separate skill of Computer Programming; use Engineer.

### **Driving** *see p. C1123 or pp. VE143-144*

Available specializations are construction equipment and locomotive.

### **Electronics** *see p. B60*

There is no separate skill of Electronics in the Age of Steam. A character with Engineer still may specialize in electrical machinery and power.

### **Electronics Operation** *see p. B58*

There is no separate skill of Electronics Operation in the Age of Steam. Substitute Mechanic or Engineer with an appropriate specialization, or Physics for experimental apparatus.

### **Forward Observer** *see p. C1151*

In the late 19th century, naval gunnery is directed by fire control officers in observation posts high above the deck of a ship, using a naval version of Forward Observer. Naval officers have -3 to skill when directing land artillery fire; conversely, army officers have -3 when directing naval gunnery.

### **Genetics** *see p. B61*

While Gregor Mendel established the basis of genetics in the 19th century, his work was ignored until after 1900. The skill of Genetics is thus not available.

### **Gunner** *see p. B50*

The specializations of cannon, grenade launcher, machine gun, mortar, rocket launcher, and torpedo are commonly available; others may require an Unusual Background or not be allowed.

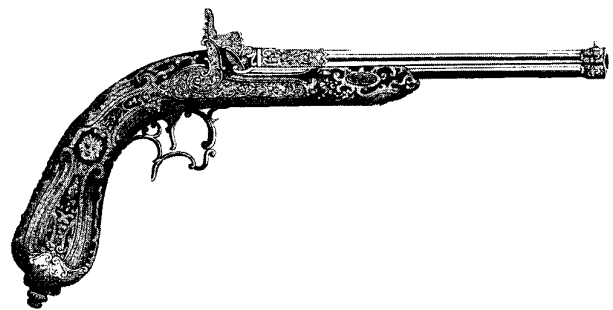

### **Guns** *see p. B51 and p. C1121*

This skill applies to weapons using smokeless powder, invented in 1885. The specializations of pistol, rifle, and shotgun are commonly available; others may require an Unusual Background or not be allowed.

### **Linguistics** *see p. B61*

Explorers often need to learn the basics of a language in a hurry. In a cinematic campaign, anyone with Linguistics skill can attempt a Linguistics roll once per day when confronted with a new language. A success gives the linguist a default skill in the language (IQ-4 for easy languages, IQ-5 for average languages, IQ-6 for hard languages, IQ-7 for very hard languages). A critical success allows communication to begin immediately.

Modifiers: +2 to learn an easy language; -2 to learn a hard language; -4 to learn a very hard language; -3 to learn by just overhearing; if able to talk with a native speaker with Linguistics skill, +1/10 of that skill (rounded down).

### **Nuclear Physics** *see p. B61*

The skill of Nuclear Physics is not available.

### **Photography** *see p. B47*

Photography is available after 1839, when Louis Daguerre developed the daguerrotype. Chemistry is a prerequisite until 1888, when George Eastman began selling film and developing services.

### **Piloting** *see pp. VE144-145*

Available specializations are balloon and lighter-than-air.

### **Psionics** *see p. C1158*

In the Age of Steam this may include the study of ghosts, spirits, and the afterlife.

## **Savoir-Faire**

*see p. B56*

This includes the vital skill of determining who has precedence in a social situation. The higher-ranked gentleman goes in to dinner ahead of the lower, has first claim to escort the lady of his choice, and has the lower-ranked gentleman introduced to him first. ("Your Grace, may I introduce my cousin, Lieutenant Bertram Cholmondely? Bertie, His Grace Robert, the Duke of Avon.") A failed roll gets you talked about; a critical failure in public earns a permanent -1 Reputation.

A GM who wants to emphasize social interaction may define maneuvers for this skill, from the Cut Direct (ostentatiously not seeing another person's greeting) to the Assertion of Previous Acquaintance ("I beg your pardon, but weren't you and I at Magdalen College together?"). Manuals of etiquette will suggest possibilities.

## **Shiphandling**

*see p. VE145*

Available specializations are sailing (which includes handling craft propelled by oars), steamer, and submersible.

## **Surgery**

*see p. B56*

In 19th-century Great Britain and many other countries, medicine and surgery are separate professions; Great Britain had a Royal College of Physicians and, after 1843, a Royal College of Surgeons. Surgery therefore does not have Physician as a prerequisite. Instead, First Aid is a prerequisite; most surgeons begin training as wound dressers.

The Manual Dexterity advantage increases Surgery skill.

## **Teamster**

*see p. B47*

The skill of Animal Handling is not a prerequisite for Teamster in the Age of Steam; too many people drive carriages or wagons without knowing how to train horses, mules, or oxen. Of course, if the vehicle is upset or the team is spooked, the driver will have very little chance of calming them; let Animal Handling default to Teamster-4 for this purpose.

## **Telegraphy**

*see p. B55*

Several technologies for signaling exist in the Age of Steam, including signal flags, semaphores, the electric telegraph, and the heliograph; treat these as required specializations. The heliograph and the electric telegraph both use Morse code and default to each other at -2; the others use different codes and have no defaults. Manual Dexterity adds to any of these skills.

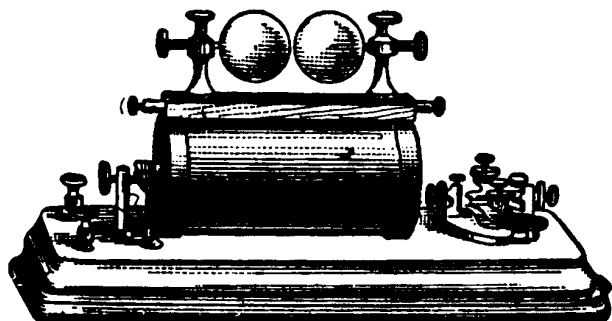

# CHARACTERS

## TL(5+1) SKILLS

Most skills have the same general definition at TL5 and at TL(5+1), even those for which tech level is significant. However, the nuances of the skill are sometimes of interest. Here are some notes on specific abilities that various TL(5+1) skills do or do not include.

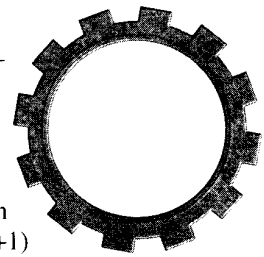

### **Architecture**

*see p. B59*

The scale of buildings is constantly increasing at TL(5+1); architects design skyscrapers or entire futuristic cities. Stylistically, think either grimly industrial or art deco (for example, *Metropolis*).

### **Armoury**

*see p. B53*

TL(5+1) armourers are not required to specialize.

### **Artificial Intelligence**

*see p. CI155*

Artificial intelligence is purely algorithmic rather than based on neural nets; the greater difficulty of this approach makes this a Mental/Hard skill. It is typically used to develop suitable maneuvers for mechanical men or analytical engines that have Rote Learning.

### **Beam Weapons**

*see p. B49*

Depending on the campaign world, specializations of this skill may include disruptor, etheric shock gun, flasher, screamer, and stunner.

### **Computer Programming**

*see p. B60*

Fully programmable, nondedicated devices become available at TL(5+1). They still have neither terminals nor the kind of operating systems that create easily accessible interfaces. Programming them involves actually readjusting the workings of the mechanism; it thus has Mechanic as a prerequisite (with an appropriate specialty), rather than Computer Operation. Alternatively, it is possible to have Mathematics as a prerequisite for Computer Programming, but the resulting "programs" are actually algorithms, not optimized for any particular engine; treat the "programmer" as unfamiliar with all engines (-2 to skill).

### **Criminology**

*see p. B60*

If criminal behavior indicates evolutionary regression to a less advanced human type, criminologists may study criminals' bodies as well as their minds.

### **Driving**

*see pp. B68 and VE143*

New available specializations include automobiles, heavy wheeled vehicles, and possibly mecha.

### **Genetics**

*see p. B61*

Genetics and eugenics are closely linked fields at TL(5+1).



### **Jeweler**

*see p. B53*

For the proper retrotech feel, consider having jewelers work in osmium, iridium, and other uncommon metals in preference to silver and gold. In a world where industrial use of electricity is delayed, aluminum will remain a precious metal.

### **Mathematics**

*see p. B61*

Mathematics emphasizes solution of equations and computation, especially if analytical engines are available; abstract theories are less emphasized and the paradoxes of 20th-century mathematics are not even imagined. Ambitious mathematicians look forward to being able to calculate everything in the universe.

### **Mechanic**

*see p. B54*

New required specializations of Mechanic may develop for analytical engines, for mechanical men and automata, and for various types of vehicles and power plants. The specialization of clockwork and small gadgets applies to many types of automata.

### **Metallurgy**

*see p. B61*

The emphasis at TL(5+1) is on developing better forms of steel, not on light metals, except for specialized purposes.

### **Navigation**

*see pp. B57 and VE56-58*

For both ocean ships and airships, advanced navigation relies on beacons, commonly using visible light, though Hertzian waves (radio) are also possible. A craft in line of sight of at least two beacons can identify its position within 1 mile.

### **Physician**

*see p. B56*

TL(5+1) medicine is best envisioned as "TL5 medicine, but more so." Treatment of diseases relies on inorganic toxins such as arsenic and mercury and on developing synthetic compounds of these toxins that are relatively harmless to human patients, but still lethal to bacteria. Salvarsan and sulfa drugs fit this pattern. Vaccines and serums are also important concerns.

### **Piloting**

*see pp. B69 and VE144-145*

Many new specializations become possible, depending on the campaign world. Glider, interplanetary ship, and ornithopter are especially idiomatic.

### **Shipbuilding**

*see pp. B52 and CI137*

At TL(5+1), shipbuilding remains Mental/Hard, defaulting to IQ-6. Up to three specializations are possible, depending on the campaign world: watercraft, airships, and interplanetary ships. In a realistic campaign allow them to default to each other at -4; in a cinematic campaign, at -2.

## **NEW SKILLS**

### **Epidemiology/TL (Mental/Hard)**

**Defaults to Cartography-4 or Intelligence Analysis-4**  
**Prerequisite: Physician**

Epidemiology is effectively medical detective work, the skill used to trace the path by which a disease has been spread. A successful Epidemiology roll can identify an asymptomatic disease carrier, find a location where people have been infected, or show the characteristic route by which a disease is communicated from one victim to another. Modifiers: if working with an analytical engine, increase effective skill by its Complexity when looking for statistical patterns.

### **Etheric Science/TL(5+1)** **(Mental/Very Hard)**

**No default**  
**Prerequisites: Physics-15+ and Mathematics-15+**

In a world where classical physics is an accurate model of reality (see pp. 94-97), Etheric Science is the skill analogous to Nuclear Physics: the study of the luminiferous ether, the material medium for light and other electromagnetic waves.

### **Phrenology (Mental/Hard)**

**Defaults to Psychology-4**

The skill of assessing mental traits from the shape of the skull. Phrenology is a pseudo-science, and in the interest of game balance should be treated as a half-cost Hobby skill (see p. B54) rather than as a Scientific skill. But in a Weird Science campaign (see p. 107) it just might work!

## **ECONOMICS, JOBS, AND WEALTH**

### **CURRENCY AND PRICES**

To keep notation simple and reasonably consistent, *GURPS* customarily lists prices in dollars (\$), equated to some coin or unit of wealth in a given historical setting. In the historic Age of Steam the United States dollar actually existed, and it is used to list prices in *GURPS Steampunk*. As stated on p. B16, starting wealth for this period is \$750.

Most characters must put 80% of their starting wealth into furniture, carriages, and other fixed assets, leaving only 20% for adventuring gear and spending money.

However, the most widely accepted currency is not the dollar, but the pound sterling; the natural impulse of any merchant or banker is to define the worth of other currencies in relation to sterling. The GM who wants historical flavor may wish to use British currency rather than dollars.

British currency is not decimal. The basic reckoning is in pounds, shillings, and pence, abbreviated £.s.d.; one pound equals 20 shillings, and one shilling equals 12 pence. Through most of the century, a pound equals five dollars (starting wealth is £150, as stated on p. B16); a shilling equals 25 cents; and a penny equals a bit over two cents in American money. Amounts are written in the form £6 13/4 (read "six pounds, thirteen and four"), though such forms as 13s. and 4d. are also used. The full system is much more complicated, running from the farthing (one-fourth of a penny) up to the guinea (21 shillings, or a pound plus a shilling). Quoting prices in guineas rather than pounds carries more prestige; luxuries and expensive items such as carriages are priced in guineas.

The franc, used in France and its colonies, fluctuates in value, but averages 8d. or \$0.17. The rupee, used in India, is worth 2s. or \$0.50.

### Price List

#### Food

Inexpensive meal	\$0.25
Beer, 1 quart	\$0.10

#### Clothes

Workman's clothing	\$1.00
Ordinary man's suit	\$6.00
Formal man's suit	\$25.00
Pair of shoes	\$2.50
Pair of boots	\$5.00
Pocket watch	\$10.00

#### Sundries

Newspaper	\$0.02
Inexpensive book	\$0.10
Cheap cigar	\$0.05
Postage, half-ounce domestic letter	\$0.02

#### Equipment

Navigational instruments	\$20.00
Set of handcuffs	\$4.00
Lantern	\$1.00
Rope, 30 ft	\$0.10
Camping gear	\$10.00
Coal, 1 cf	\$0.08
Coal, 1 ton	\$2.75

#### Travel

Pony	\$100.00
Carriage horse	\$500
Matched pair of horses	\$2,500
Gig	\$125.00
Brougham	\$750.00
Coach	\$2,500.00
Cabfare, one passenger, 2 mi. (minimum fare)	\$0.12
Hotel room, by the night	\$5.00
Cook's tour, five days in Paris	\$26.75
Cook's tour, three months in Egypt and the Holy Land	\$600.00

## SOCIAL STATUS AND COST OF LIVING

Level	Monthly Cost of Living
7 Royalty	\$6,000
6 Duke, archbishop, President of the United States	\$3,000
5 Marquess, Earl, Baron, Viceroy, prime minister, state governor	\$1,000
4 Wealthy gentry, Cabinet member, senator	\$500
3 Gentry (knight or baronet), judge, member of Parliament, congressman	\$250
2 Wealthy professional	\$200
1 Professional (clergyman, doctor, lawyer), wealthy tradesman, large farmer	\$100
0 Tradesman, small farmer	\$50
-1 Factory worker, farmworker, enlisted man, servant	\$25
-2 Seasonal worker, actor	\$10
-3 Beggar, ragpicker, petty criminal, lunatic	\$2.50



## JOB TABLE

### Job (Prerequisite), Monthly Income

#### Poor Jobs

Job (Prerequisite), Monthly Income	Success Roll	Critical Failure
Beggar* (none), Streetwise × \$0.25	HT	-1i/1d
Groom (Savoir-Faire (Servant) 10+), \$7.50, room and board	PR	LJ
Enlisted man (Black Powder Weapons or Guns 12+, Savoir-Faire (Military) 12+), \$10, quarters	Weapon skill	-1i/1d
Factory worker, female (no prerequisite), \$12.50	DX	-1i/1d
Street vendor (none), Merchant × \$0.50	IQ	-1i/-2i

#### Struggling Jobs

Blacksmith* (Blacksmith 12+), ST × \$2.50	PR	-1i
Cabman* (Teamster 12+, Area Knowledge 12+), Area Knowledge × \$3	HT	-1i/-2i, 2d
Clerk (Calligraphy 12+, Administration 12+), \$20	Worst PR	-1i/LJ
Coachman (Teamster 12+), \$15 room and board	PR	LJ
Factory worker, male (no prerequisite), \$25	DX	-1i/1d
Noncommissioned officer (Leadership 12+), \$20, quarters	PR	-1i/demoted or 2d
Policeman (Streetwise 12+), \$25	PR	1d/3d or LJ
Wound dresser (First Aid 12+), \$20	PR	-1i/LJ
Writer* (Writing or Poetry 12+), \$30	PR	-1i/-3i

#### Average Jobs

Carriagemaker* (Mechanic 12+, Woodworking 12+), \$50	Worst PR	-1i/LJ
Clergyman (Theology 12+), Bard × \$10	PR	-1i/LJ
Demimondaine (Courtesan 12+), Courtesan × \$10	Courtesan	LJ/LJ, -1 Reputation
Subaltern (Savoir-Faire (Military) 12+, Leadership 12+), \$50	Worst PR	2d
Telegraph Operator (Telegraphy 12+), \$40	PR	-1i/LJ

#### Comfortable Jobs

Colonel or post-captain (Tactics 12+, Leadership 12+), \$100	Worst PR	2d/lost command
General or admiral (Strategy 12+), \$250	PR	LJ
Instructor in swordsmanship (Fencing 14+, Teaching 12+), \$125	Teaching	-1i/1d
Solicitor* (Law 12+, Administration 12+), \$100	Worst PR	-1i/-2i
Surgeon* (Surgery 14+), \$125	PR	-2i/1d
University professor (Academic skill 14+, Teaching 12+), \$175	Academic skill/	LJ

#### Wealthy Jobs

Barrister* (Law 14+) Law × \$20	PR	-1i/LJ
Doctor* (Physician 12+, Status 1+) Physician × \$15	PR	-1i/-3i
Industrialist* (Administration 12+, Merchant 12+, Very Wealthy), \$200	Merchant	-3i/LJ, -1 Wealth level

\* Freelance occupation; see p. B193.

## USING CHARACTERS FROM HISTORY AND FICTION

The key historic figures of the 19th century, major and minor, are usually well documented, as are many less influential people who simply led interesting lives; the two volumes of *GURPS Who's Who* offer several examples. The fiction of the period is also a rich supply of interesting characters. Cameo appearances can liven up a campaign; some campaigns may give them continuing, even major roles, and a daring GM may allow them to appear as PCs.

The second and third options call for creating character sheets for these figures. Here are some guidelines for doing so (see pp. WWi125-127 for a fuller treatment of historic figures).

For historic figures, assign attributes conservatively. A score of 11-12 will be noticed over time as above average; a score of 13-14 will be noticed quickly by nearly everyone; 15+ is remarkably high and affects the entire shape of a person's life. Consider such "aptitude" advantages as Alertness,



Charisma, Manual Dexterity, Mathematical Ability, or Strong Will, rather than high attributes, for historic figures with somewhat specialized abilities. In a realistic campaign, one level of an aptitude is unusual, and five levels would fit the greatest figures in history.

Advantages that can be learned or trained, such as Alcohol Tolerance, Combat Reflexes, or Literacy, are appropriate in a realistic treatment, as are any "ordinary" disadvantages. Major advantages such as Eidetic Memory should be quite rare. The same applies to the more extreme disadvantages, especially mental ones such as Lecherousness, Paranoia, or Vow, which are written to portray extreme behavior. Quirk levels of such extreme traits, such as "an eye for the ladies," can be suitable for less extreme behavior.

A skill of 12 is good enough for work in most careers; a skill of 14 is good enough for risky careers such as boxer or surgeon. Highly skilled professionals admired in their fields tend to have skill 16-18. The best practitioner of an age or a nation may be at skill 19-20; the best ever could be at skill 21-25.

All these criteria can be applied more generously to fictional characters. While a real person has an entire life, with far more incidents than any biography can hold, a fictional character has only the experiences the author chooses to portray; one or two episodes can justify an advantage or disadvantage or a high attribute or skill. Literary characters were often larger than life; such scientists as Frankenstein, Jekyll, and Moreau clearly had skills well over 20, and many literary heroes and villains had extreme psychological traits.

Here is an example of such an adaptation.

## CAPTAIN NEMO 466 POINTS

Age, between 40-50; 5'11"; 160 lbs.; a striking man with a dark complexion, strong features, and straight black hair.

**Attributes:** ST 12 [20]; DX 11 [10]; IQ 15 [60]; HT 13 [30].  
Speed 6; Move 6.  
Dodge 6.

**Advantages:** Ally Group (20 men; 12 or less) [40]; Attractive [5]; Charisma +2 [10]; Filthy Rich [50]; Invention (Advanced diving suit) [5]; Invention (Cinematic primary batteries) [15]; Invention (Submarine hull) [15]; Lightning Calculator [5]; Multimillionaire x6 [150]; Peripheral Vision [15]; Versatile [5].

**Disadvantages:** Code of Honor (Aristocrat's) [-10]; Curious [-5]; Intolerance (Irrational people) [-5]; Loner [-5]; Overconfidence [-10]; Pacifism (Cannot harm innocents) [-10]; Status 0 [-5]; Vow (Exile from land) [-10].

**Quirks:** Cigar smoker; Detests the British; Loves oceanography; Brags about his inventions; Secret (He is the exiled Prince Dakkar of India). [-5]

**Skills:** Archaeology-13 [1]; Area Knowledge (The Oceans) -18 [6]; Bard-16 [1]; Body Language-14 [2]; Cartography-14 [1]; Chemistry (Electrochemistry)-14/20 [4]; Engineer (Vehicles)-20 [14]; Fishing-15 [1]; Guns (Air Gun)-13 [1]; Hard-Hat Diving-14 [1]; Hydrology-16 [4]; Leadership-16 [1]; Mechanic (Ships)-14 [1];

Meteorology-13 [1]; Musical Instrument (Organ)-13 [1]; Musical Notation-15 [1]; Naturalist (Marine Life)-12/18 [1]; Navigation-16 [6]; Physics-15 [4]; Prospecting-16 [4]; Research-14 [1]; Savoir-Faire-17 [4]; Science-14 [4]; Seamanship-15 [1]; Shipbuilding-20 [14]; Shiphandling-16 [6]; Swimming-12 [2]; Two-Handed Axe/Mace-10 [1].

**Languages:** Hindustani (native)-15; English-14 [1]; French -14 [1]; German-14 [1]; Greek-14 [1]; Latin-15 [2]; Sanskrit-14 [1].



Prince Dakkar was the heir to a kingdom in India, but was educated in England and on the Continent, mastering the languages and sciences of the West. However, in the Indian Mutiny, he attempted to lead his people in resisting British rule, failed, lost his wife and child, and had to flee. He used his wealth to construct a new vessel, the submarine *Nautilus*, in which he abandoned the land to take up life in the sea. He restored his personal fortunes with vast quantities of treasure salvaged from wrecked ships. His self-imposed exile made him lonely, and when he discovered that a man he had rescued was the famous French marine biologist Professor Arronax, he attempted to befriend him, calling himself by the Latin pseudonym *Nemo* (meaning "no one" and probably a reference to the famous seafarer Odysseus calling himself "Noman" when he spoke to the Cyclops). Ultimately, he allowed Arronax and his two companions to escape to the land.

For more details, especially of the meeting with Arronax, see the account by Verne.

# CHAPTER 4

# MATTERS OF

# LIFE AND DEATH

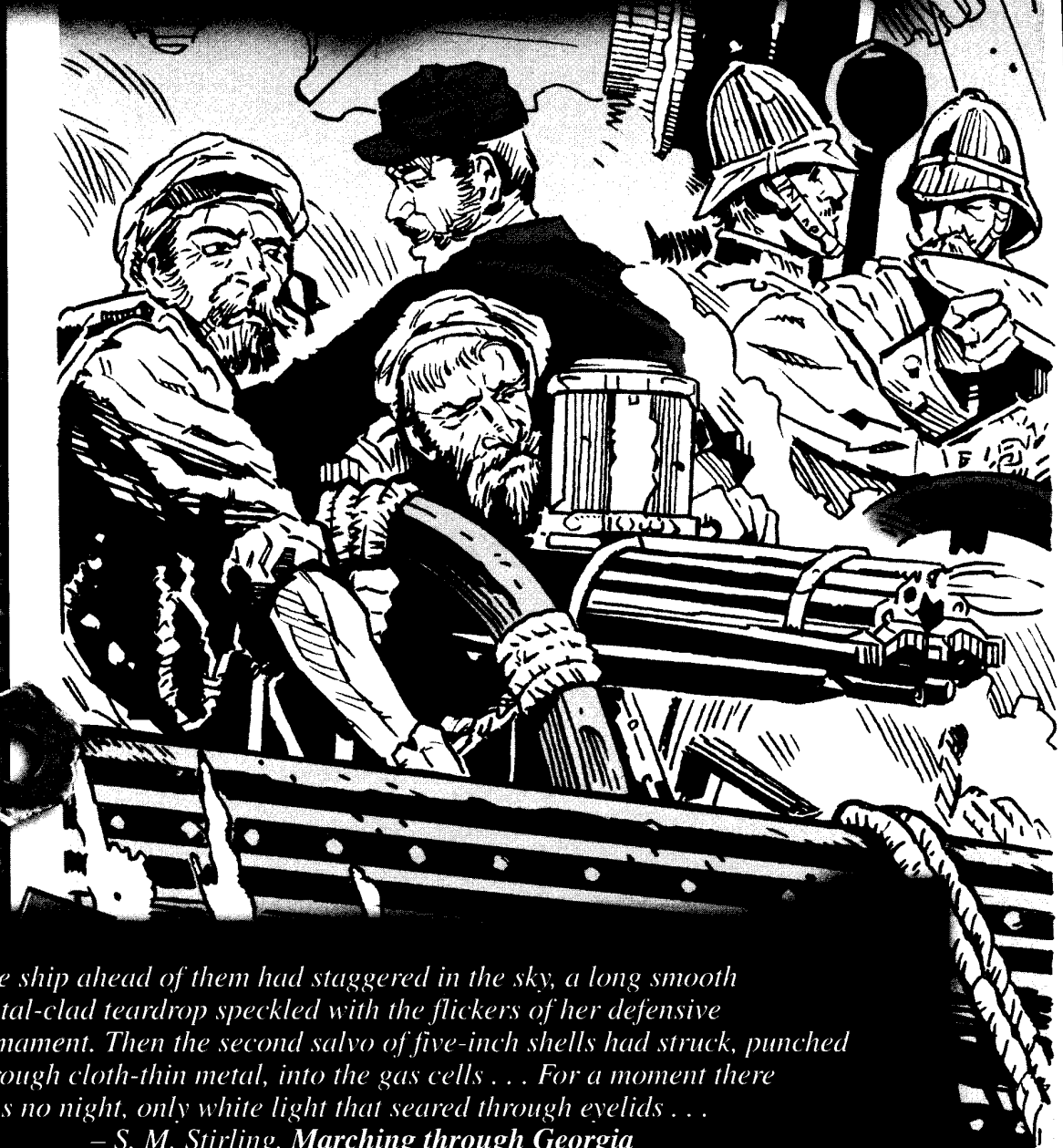

*The ship ahead of them had staggered in the sky, a long smooth metal-clad teardrop speckled with the flickers of her defensive armament. Then the second salvo of five-inch shells had struck, punched through cloth-thin metal, into the gas cells . . . For a moment there was no night, only white light that seared through eyelids . . .*

*— S. M. Stirling, **Marching through Georgia***

# THE DUEL

Dueling was illegal in the 19th century, at least in civilized countries. That didn't stop it; after all, dueling was also illegal in Richelieu's France. So long as a man fought according to polite custom, and no one died in the confrontation, the authorities were likely to stay out of the matter.

In order to initiate a duel, one person must be the challenger, issuing the initial demand for "satisfaction." The challenger and the challenged choose seconds to negotiate time and place; the challenged gets to choose the weapons. Since the choice is important, two potential duelists may try to maneuver each other into making the challenge. Treat such an attempt as a contest of skills using *Savoir-Faire*. Eccentric choices of weapons such as "batleaxes at three paces" may be dismissed as frivolous, although several historical duels were fought with even stranger implements.

If one of the principals does not appear, his second must fight in his place, or apologize. A pair of matched weapons must be provided; if one combatant provides the weapons, the other gets to choose first. Combat is preceded by the referee or a second asking if the combatants can resolve their differences peacefully. The participants may agree to fight "to first blood" – that is, until either is wounded – or in a pistol duel to a single exchange of shots. For more serious slights, a duel may be fought until one duelist is unable to continue fighting because of serious injury, or even to the death, although this is rare. In a pistol duel, the first exchange of shots may be followed by the seconds asking if they will consider that honor is satisfied.

If swords are used in a duel, the relevant skill is Fencing; if pistols are used, the relevant skill is Black Powder Weapons (Pistol). In pistol duels the combatants stand at a distance, typically 10 to 20 paces. Pistol duelists are expected to fire immediately, without taking time to aim; Speed and Fast-Draw skill are important in duels.

A steampunk campaign opens up a whole new range of weapons which combatants might choose, from laser pistols to steam automata. While it is unlikely that the gentleman in the street would have access to such technology, PC duelists are another matter entirely. Inventors could choose to fight with any lethal oddity they created, so long as they could provide an identical weapon to their opponent. In a campaign with magic or psionics, mages or mediums might duel with one another using the special tools of their trades.

See *GURPS Castle Falkenstein* for a detailed description of dueling. A different version of dueling, the gunfight, is discussed in *GURPS Old West*.

## "CIVILIZED" WARFARE

Civilized warfare (as defined by Western European nations) was governed by elaborate conventions about proper military conduct. Underlying these was a sharp distinction between combatants (enemy soldiers) and noncombatants (civilians, including enemy civilians). Combatants were legitimate targets of deadly force; civilians were not. Of course, in a war, accidents happened, but military forces were supposed to try to avoid them.

## MARTIAL ARTS

The unarmed combat skills of Asia are almost unknown in Europe during the Age of Steam. Until late in the century, there are not even legends about them. Western characters need a 10-point Unusual Background to learn Judo or Karate or any maneuvers that depend upon them.

In 1899, E.W. Barton-Wright (see pp. WWi98-99) opened the first western school of martial arts in London, teaching a version of jujitsu which he called baritsu. Arthur Conan Doyle described Sherlock Holmes as a student of these skills.

During this period, the mystical and philosophical aspects of the martial arts receive little attention. Western accounts of judo emphasize balance and leverage and turning the force of an attacker's blow against him; they often sound like treatises on mechanics. Karate is even less known, though books may discuss vulnerable points where a blow may be targeted. These are thought of in terms of Western medical concepts such as nerve pathways, rather than chi or prana.

## THE PLAYING FIELDS OF ETON

The Duke of Wellington said "The battle of Waterloo was won on the playing fields of Eton." Whatever truth there was in this, many of his countrymen believed it. Sports, particularly team sports, cricket and football, were considered essential to a young man's education. A boy at Eton, Harrow, or Rugby faced punishment if he did not participate.

This may be just an aspect of the Genteel Proficiency Delusion (see p. 45). But even in a realistic Age of Steam campaign, athletes may gain such advantages as Fit or High Pain Threshold. Team captains have a chance to learn Leadership. Many British officers, such as Kipling's friend General Dunsterville ("Stalky"), believed they had a special rapport with their men, unknown in other countries; in a campaign where this is true, sports may help explain it. If so, consider Charisma as an advantage for successful athletes.

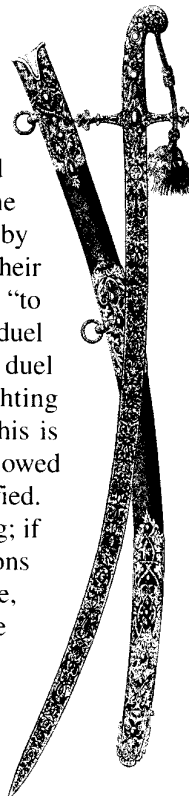

## SCIENTIFIC FISTICUFFS

The modern sport of boxing goes back to the 18th century, when Jack Broughton proposed the first formal rules for matches. These were replaced in 1839 by the London Prize Ring rules, which banned kicks, bites, and head butts. The modern form of the sport emerged in 1867, when John Graham Chambers proposed new rules that banned wrestling moves and required padded gloves; the Marquess of Queensberry allowed their publication under his name, hoping to make boxing respectable. Prizefighters did not accept the new rules until 1892, when John L. Sullivan insisted on them in his championship fight against Gentleman Jim Corbett. Sullivan's motives were not entirely disinterested; bare-knuckles fighting was illegal throughout the United States, and his 1889 championship fight against Jake Kilrain had cost him \$18,760 in fines and legal costs.

Boxing was always popular with the working classes, especially in the United States. From the beginning it was open to Irishmen, Jews, and other outsiders – two former slaves from the United States, Bill Richmond and Tom Molineux, boxed professionally in England before 1815. Boxing offered a man with good physical attributes and a high pain threshold a way to better himself economically.

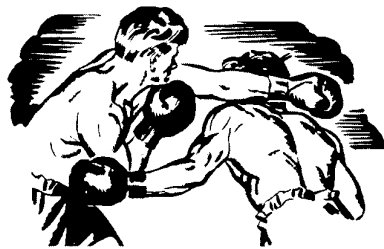

The idea of boxing as a science was created by Daniel Mendoza, a 160-pound English Jew whose quick footwork and left-handed jabs enabled him to take the championship from much stronger opponents. The techniques of Boxing can be learned any time after 1795, when Mendoza opened his school in London. After 1867, Boxing Sport is a separate skill, defined by the Marquess of Queensberry rules. The belief that Boxing Sport can substitute for Boxing may form part of the Genteel Proficiency Delusion (see p. 45). Working-class characters may still learn bare-knuckles techniques and use them for self-defense or to settle disagreements; treat this as Boxing skill.



This does not mean that civilians cannot be coerced. A government can take or occupy the property of its own civilians for military use; that property then becomes a legitimate military target. Moreover, the other side can lawfully seize or occupy property under the force of military necessity. A military commander who really needs something from civilians in enemy country can almost certainly find a justification for taking it. But a commander who runs roughshod over civilians may expose his government to pressure from other countries that could end his career.

A curious nuance of these rules is that an enemy soldier who lays down his arms becomes a noncombatant. In theory, he must not be harmed further, though troops in the heat of battle sometimes don't bother to take prisoners. An officer may give his parole, his word as a gentleman not to engage in further combat, and the enemy would expect him to keep it. Of course, there are practical penalties for breaking parole – the enemy will react with lethal force, and his own side may shun him, lest the enemy stop accepting paroles in favor of imprisonment or death. But the knowledge that some things are Not Done may weigh more heavily on a captive officer's mind.

## ON THE FRONT LINES

Over the course of the Age of Steam, battlefronts grew wider, as front rank infantrymen were spaced farther apart. The increased speed and accuracy of small arms allowed one man to hold as much ground as half a dozen in the previous century. That same speed and accuracy made it dangerous to form closely spaced ranks. Starting with the American Civil War, infantrymen spend as much time as possible under cover, even in combat. Camouflage, Engineer (Military), and Stealth become essential skills. Infantry advances are made by sending a few men at a time to the front, preferably without the enemy seeing them, followed by a final rush against the enemy position.

Infantrymen are taught to maintain fire discipline – to shoot at a designated target area at a designated range. A bullet has only a small chance of hitting a soldier on the other side; what kills the enemy is massed fire. But for officers to direct that fire effectively, it all has to be aimed at the same area; then they can see the statistical center of the bullet impacts, estimate its range and direction from the intended target, and give orders for corrected aim.

If soldiers don't maintain fire discipline, they probably won't know if they've hit anything. The GM should make all Gun rolls under battle conditions. A critical success on a Vision roll should be required for a soldier to see if he hit the target.

None of this applies to snipers, or in any other circumstance where a small party of soldiers are firing at visible adversaries. Remember, though, that the adversaries won't remain visible after the first shots go off if there is anywhere to take cover.

## MECHANIZED WARFARE

Steam and steel offer the prospect of a mechanized battlefield; H.G. Wells envisioned "land ironclads" overwhelming traditional armies. Such vehicles would be unlikely to resemble 20th-century tanks. Steam engines are bulkier than diesel engines and operate most economically on a large scale. A plausible armored land vehicle might be slow and have a large turning radius, carrying massive armor and huge guns. (See Chapter 5 for a prototype.) A fleet of half a dozen such monsters could overwhelm any defensive line or fortification. Ultimately, landfleets themselves might provide a nation's main defensive fortifications. Really large land ironclads might be organized more like ships than like army units; Britain or some other seagoing nation might even make them a branch of the navy rather than the army.

## AERIAL COMBAT

The first application of flight in warfare was the use of tethered balloons as observation posts; this goes back to the French Revolution and the Napoleonic Wars. Observation balloons were used in the American Civil War and the Franco-Prussian War. Balloons at 2,500', the length of a telegraph cable, could see up to 50 miles. In a lower-tech version, balloonists at 400' (visual range 20 miles) could simply throw notes over the side.

A few experiments were made in the military use of powered airships, and a steampunk world may take this much further. One way of doing so is to use airships as long-range military transport, taking advantage of their relatively high payload; unhindered by terrain other than mountains, airships might allow much more flexible logistics and reduce the need to protect railways. Airships can also serve as bombers.

A more dramatic use for airships would be as artillery platforms. Such airships would be analogous to battleships, being able to attack at great range and to travel at high speeds, but lacking maneuverability. They would also share the vulnerability of battleships, especially since they could hardly carry much armor. Fleets of airships might need to be accompanied by smaller, faster craft – whether powered airplanes or gliders or more exotic craft such as ornithopters – to screen them from similar craft on the other side.

Both airships and airplanes were used for aerial reconnaissance as well. Airships were actually a superior technology for this purpose; early cameras worked better with a stable platform, and airships' large volumes and low speeds made them more stable.

## MATTERS OF LIFE AND DEATH

### MILITARY ORGANIZATION AND RANK

Ranks in the British army can be defined as follows in *GURPS* terms:

Title	Rank
General, lieutenant general,	
major general	8
Brigadier	7
Colonel	6
Lieutenant colonel	5
Major, captain	4
Lieutenant	3
Sergeant-major, first sergeant	2
Sergeant, corporal	1
Private	0

In the British army for most of the century, the basic military unit is the company, commanded by a captain. Its wartime strength is 123, of whom 110 are privates. Larger units are the battalion, made up of eight companies and commanded by a lieutenant colonel; the brigade, made up of three battalions and commanded by a brigadier; the division, made up of six battalions, commanded by a general; and the army corps, made up of 18 battalions, also commanded by a general. All these larger units include support forces and administrative staff officers; the division and corps include artillery, cavalry, engineers, military police, and other specialized units. Wartime strength is 9,600 for a division and 34,000 for an army corps.

(The regiment, "five hundred fighting Englishmen, the colonel and the band," exists mostly on paper. In 1870, all but a few of Britain's regiments comprise a single battalion each.)

The United States has a similar organization for most of the century. Continental armies follow a different pattern: a typical battalion is divided into only four companies, not eight, and, a company is divided into platoons, each headed by a lieutenant. The British army adopted this structure in the 1870s, later than the other major powers.



## PURCHASED COMMISSIONS

Until the 1850s, commissions in the British army were bought and sold. Sir Walter Scott paid £3,500 (\$17,500) to buy his son a captaincy and another £1,000 (\$5,000) for uniforms and equipment, and commented on what a high price this was for a position that paid only £400 (\$2,000) annually. Actually, this was an 8.9% return, much higher than government bonds. Becoming an officer was much like buying a franchise. Since there were no military pensions, an officer's ability to sell his position when he left it was also his retirement fund – fear of losing such investments was one of the main sources of opposition to abolishing the purchase of commissions. When purchase was finally abolished a system of retirement pensions was instituted.

## RAIL TRANSPORT AND LOGISTICS

Powered vehicles played almost no part on 19th-century battlefields; the relevant skills are Hiking (for the infantry), Riding (for the cavalry), and Teamster (for engineers and field artillery). But to reach the battlefield in the first place, armies increasingly relied on the railroad. It was faster, it could carry heavier loads of supplies, and it cost less per ton-mile than feet or horses. Military officers were well aware of this; the Prussian chief of staff, Helmut von Moltke, said that it was better to spend money on railroads than on fortifications. Reliance on railroads changed many aspects of war.

First, multiple-front engagements became common. Transporting one infantry regiment took 10 trains; a full division occupied miles of track and took hours to unload. Getting an army into battle required multiple tracks, which meant multiple parallel advances into enemy territory.

Second, railroads operated on timetables. There was little room for improvisation; movements of men and supplies had to be coordinated, which meant extensive advance planning.

Third, railroads themselves became a major strategic objective. Capturing the enemy's rail made it possible to invade his territory; destroying it cut off his forces from their sources of supply. During the American Civil War, armies frequently directed their attention toward the opposition's rail lines.

Conversely, the needs of war became a major stimulus to the building of railroads. In Germany, the army subsidized railways, just as the United States in the 20th century would one day subsidize freeways in the interest of national defense.

# COLONIAL WARFARE

Colonial warfare was the antithesis of civilized warfare. It was actually far more lethal; native peoples seldom had much regard for European ideas about respect for noncombatants or mercy to defeated foes, nor did Europeans view their native adversaries as deserving such chivalry. Soldiers from European nations tended to be better armed than their tribal opponents and thus able to stand off large numbers of opponents; but when they failed, they were slaughtered.

In infantry combat, European soldiers have an important advantage over tribal adversaries: their training emphasizes formations in which each man helps defend his neighbors, making it hard for an enemy to surround any of them. The famous "British square" and similar formations largely negate the benefits of superior numbers. They also have useful psychological effects; allow +1 to Leadership rolls if the men being led are in formation, from the sense of security that results. If the enemy break the square, further Leadership rolls are at -1.

Cavalry, already becoming obsolete on European battlefields, comes into its own in the colonies, especially the open plains of northern India and the American West. The enemy seldom have rapid-fire weapons, so a cavalry charge can reach enemy lines. The open formations of most uncivilized opponents offer no protection against the shock of a cavalry charge. And since many such opponents are also mounted, the mobility of cavalry is needed to pursue them effectively.

Curiously, the kings of some Asian countries have very good artillery, often up to the highest European standards; the Sikhs of the Punjab are an example. It is much easier to hire or train a few artillerymen than many infantrymen, and armament manufacturers such as Krupp gladly sell modern weapons to Asian monarchs. European soldiers in some colonial wars face undisciplined mobs of foot soldiers or horsemen backed up by high-precision artillery fire.

## NAVAL COMBAT

The evolution of naval warfare between 1815 and 1914 was something of a paradox. There were few naval battles, and Britain's control of the seas was never contested, but naval technology developed with unprecedented speed. At the start of the era, three-masted ships of the line controlled the seas; at the end, steel dreadnoughts played the same role. In between came a period of transition, dominated not by any one technology or ship design (despite being called "The Age of Steam") but by a series of radical innovations and experiments.

## THE AGE OF SAIL

Sailing ships depend on the wind to maneuver. A ship's speed varies with the angle between its course and the wind: 80% of maximum speed if the wind is from astern, 100% if it is on the quarter (from astern at an angle), 80% if it is from abeam, 20% if it is on the bow (see pp. VE158-159). This constrains both tactics and strategy.

Tactically, opposing fleets typically form parallel lines, so that the sides of enemy ships face each other; hence the designation "ship of the line." Ships sail at an angle to the wind, rather than running before it, so one line must be upwind from the other. The *windward* ships have the initiative in a

naval engagement, being able to keep their distance from the opposing *lee-*ward ships, or close and attack. If the leeward ships break off the battle, they can stay ahead of the windward ships and escape; but to hold their position they must meet the windward ships' attack.

Attacks are made with cannon fire, broadside against broadside. The effective power of a ship depends on the weight of metal its cannon can fire, the time needed to reload, and the accuracy of its fire at a given range. Ranges of a few hundred yards are typical. During the early phases of battle, fire may be directed either at the rigging (favored by the French) or at the hull (favored by the British). Special types of ammunition may be used in each case: pairs of cannonballs joined with chains to cut the masts, or cannonballs heated red-hot to set fire to the hull or explode the magazine. When a ship is at a disadvantage, an enemy ship may close with it, fire cannonballs or small shot at the crew, and then grapple, board, and fight hand to hand.

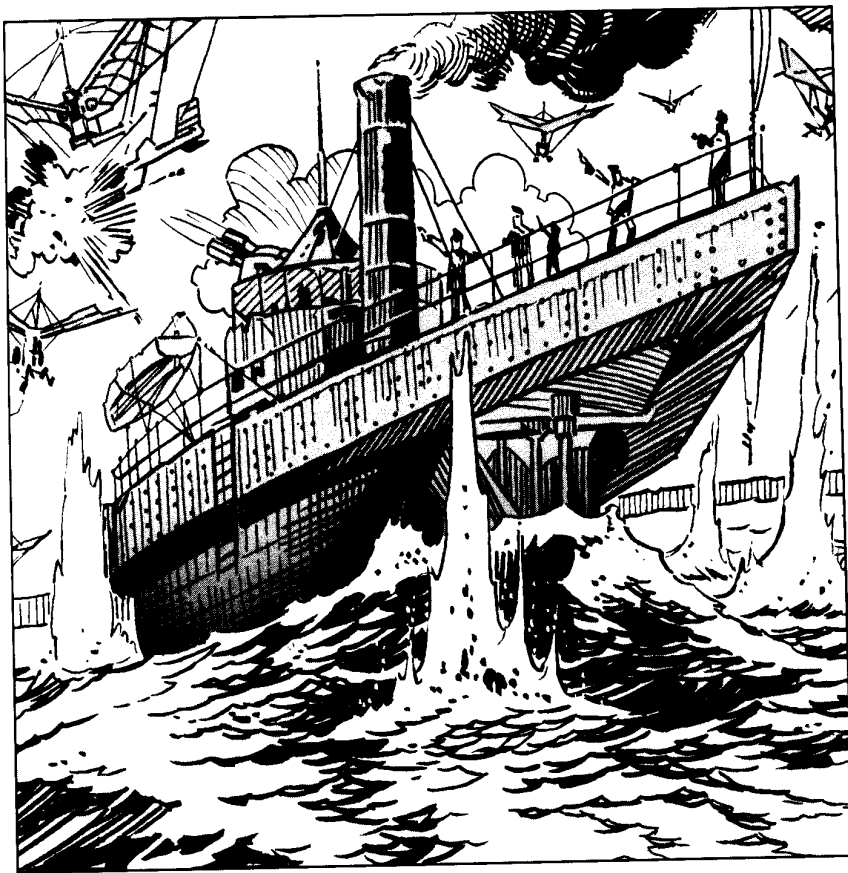

Ordinary tactics of line against line tend to produce indecisive results. A fleet with superior numbers may form a double line, gaining twice the firepower against each enemy ship. A fleet situated to windward can sail through the leeward fleet's line, called "crossing the T"; as it passes through, its ships fire broadsides down the length of the enemy ships, while exposed only to the small volume of fire from the enemy's bow or stern guns.

Strategy emphasizes position relative to the wind: windward for fleets that want freedom to attack (which the British favor), leeward for fleets that want to make the foe come to them (which the French usually prefer). Either Meteorology or Area Knowledge can identify the characteristic pattern of winds in an area.

For more on Age of Sail warfare, see pp. SW108-116 or CII94-99.

## COMMUNICATIONS

Armies in the 19th century still relied on traditional methods for coordinating their actions: bugle calls for short-range tactical signals and runners or riders to carry information and orders between headquarters and the front lines. But a variety of newer technologies allowed more rapid communication.

At the start of the century, shutters and semaphores (on land) and signal flags (at sea) allowed strategic communication. Both the sender and the receiver needed to be elevated, in towers or in the masts of ships; effective visibility in miles can be estimated as the square root of the sum of the sender's and receiver's heights above sea level in feet. Telescopes improved visibility at range. On good days a semaphore message could be sent from London to Portsmouth in 5 minutes, with time for a confirmation message to come back.

The electric telegraph provided rapid communication between military headquarters and the governments they served, sometimes too rapid to suit commanding officers who wanted to make their own decisions. Its use in the battlefield was limited by the need for wires to carry messages; advancing armies easily outran their own telegraph lines. Nonetheless, signal corps officers strung miles of wire over battlefields. Of course, the messages on those wires could be intercepted: the British army officer Lord Wolseley pointed out in 1886 that "a telegraph operator can, with a small pocket instrument, tap the wires anywhere, and learn the messages passing along them." The skill of Traffic Analysis began to emerge at this time.

Armies in the field, especially in sunny desert or tropical lands, could use the heliograph, brought into use in 1879 in Afghanistan. This device used mirrors to catch the sunlight, creating flashes that could be seen up to 70 miles away under good conditions. Again, visibility was crucial, and telescopes or binoculars helped improve it. Heliographic messages used Morse code.

Finally, starting in 1903, wireless telegraphy offered effectively unlimited range, independent of sunlight, clear weather, or vulnerable wires. Navies in particular found the wireless telegraph ideal, and Guglielmo Marconi deliberately aimed to sell his invention in this market. Early transmitters were large and heavy, inconvenient for vehicles smaller than a ship, though a horse-drawn wagon could hold a transmitter and enough batteries to operate it for several days. Signals went out in all directions, so they had to be encrypted for security (see p. 61).

## THE AGE OF STEAM

### FIELD INTELLIGENCE

Military operations depend not only on long-term collection of strategic information, but on quick collection and interpretation of tactical intelligence during battles. Every field commander's staff includes an intelligence officer. Information comes to such an officer from a variety of sources. He can send cavalry on scouting missions (one officer and two troopers are considered the best scouting force); this calls for Riding and Survival as well as good vision. He can question captured enemy soldiers and local inhabitants, using Interrogation, Intimidation, or any other applicable social skill. Military doctrine emphasizes that prisoners are not to be questioned by their captors but turned over to headquarters for trained interrogation. He can recruit and manage spies; an intelligence officer is expected to have enough wealth to pay for such information. He can have written dispatches intercepted and telegraph messages tapped. Finally, he can use balloons and airships as observation platforms; treat this as a variation on Forward Observer skill. Gathering information from any of these sources can generate missions for adventurers.

### THE GENERAL STAFF

Staff work encompasses several functions and draws on several skills. Staff members need Cartography to draw accurate maps of battlegrounds (actually collecting the information depends on Forward Observer or Surveying). This is the origin of the maps that forward observers use. Gunner skill is needed to calculate trajectories for indirect fire, which allow an artillery attack to be made almost as quickly as the orders are sent out. Staff officers need Administration to mobilize and supply troops, especially to work out railroad schedules. They also engage in Intelligence Analysis to determine enemy capabilities and objectives. A roll against the average Strategy of the staff members consulted can work out a battle plan ahead of time, enabling the high command to make decisions quickly. But remember that "no battle plan survives contact with the enemy."

Staff work is primarily intellectual and may not seem to offer much prospect of adventure. But in the 19th century, at least, staff officers are expected to go out to the front lines and observe the course of battle with their own eyes. Their other duties can also become unexpectedly interesting; solving problems of supply may lead to the discovery of worker unrest, sabotage, or even enemy attacks behind the front lines, for example.

Steam-powered warships became practical with the development of the screw propeller. Between 1850 and 1873, steam supplemented sail rather than replacing it; sail was used for long voyages and as a backup in battle, while steam power let ships maneuver independent of the wind. The Age of

Sail naval combat system can be used, except that having the weather gage (i.e., your ship is windward, between the wind and the foe) against a functioning steamship has no effect on battle outcomes; any steamship attacking a ship dependent on sail should be given the weather gage automatically.

The same period saw the introduction of the ironclad and then of the iron-hulled warship. Naval guns became more powerful and solid shot was replaced with high explosive shells. Starting in the Crimean War, only metal ships were durable enough to survive a battle. The weight of armor precluded protecting the whole ship; ships had belts of armor around the hull above the waterline or had heavy armor only for the guns and the engines. Below the waterline a ship was vulnerable.

In 1873, the British navy launched H.M.S. *Devastation*, the first seagoing warship without sails. Forced-draft steam engines gave her enough fuel economy to cross the Atlantic Ocean, and twin engines and propellers meant she could fight if one engine broke down or was disabled. The abandonment of sails let her carry turreted guns that could fire in any direction without being blocked by masts. All these features became standard in the last quarter of the century, the first battleship era.

Battleships continue to fight at close range, less than a mile. They are heavily armored to withstand enemy fire, limiting speed and maneuverability. They are vulnerable to torpedoes, which attack below the waterline; this leads to the invention of a new type of ship, the torpedo-boat destroyer (later just *destroyer*), a fast, lightly armored ship that can intercept torpedo boats, and to a fleet composition doctrine that calls for a mix of light and heavy ships.

The most important strategic factor is the ability to refuel. The British navy established coaling stations around the world, often on small islands; the French and Americans followed their example, but too late to claim the best-placed locations.

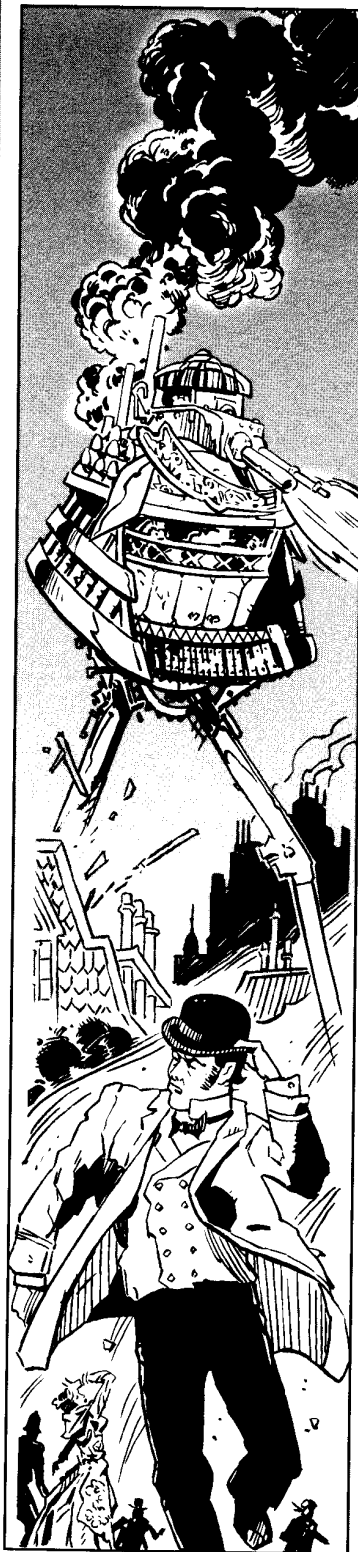

# THE DREADNOUGHT AGE

The full potential of the new naval technologies was only realized in the early 20th century. The Battle of Tsushima Straits in 1905, the first major battleship fleet engagement, demonstrated a new way of using battleships, with exchanges of fire at over 7 miles. In the same period, the construction of H.M.S. *Dreadnought*, launched in 1906, set a new standard for battleships. Steam turbines made her the fastest battleship on the seas, while steel construction and ten 12" guns enabled her to deal out, and endure, unprecedented amounts of damage.

## Gunnery and Fire Control

Naval combat at TL(5+1) rests on long-range gunnery. This is similar to indirect artillery fire on land, but with important changes.

Naval guns are fired in salvos, with all guns that can bear on a target firing simultaneously. A single roll is made for the salvo, using the average effective Gunner skill for all gun crews. Depending on the number of shots fired and the margin by which the roll succeeded or failed, a varying number of shots hit.

## Gunner Salvo

Shots	Margin							
	-3	-2	-1	+1	+2	+3	+4	+5 or more
1	0	0	1	1	1	1	1	1
2	0	0	1	1	1	1	1	2
3	0	1	1	1	1	2	2	3
4	0	1	2	2	3	3	3	4
5	0	1	2	3	3	3	4	5
6	0	1	3	3	4	4	5	6
7	0	1	3	4	5	5	6	7
8	0	1	4	4	6	6	6	8
9	0	1	4	5	6	6	7	9
10	1	2	5	5	7	7	8	10
11	1	3	5	6	8	8	9	11
12	1	3	6	6	9	9	9	12

Indirect fire can be used against targets as far away as 2.5x normal maximum range for a gun, or as close as 25% of normal maximum range. The guns are not pointed at the target, but upward at an angle. Typically, the gunners can't see the target, which must be designated for them by a fire control officer high above the deck. (The required height in feet approximately equals the square of the target range in miles.) Two skills are involved: the naval version of Forward Observer for the fire control officer and Gunner for the gun crew.

On the first salvo, modifiers to Forward Observer are -1 for the naked eye (no modifier if using a spyglass); -1 to -5 for bad weather; and -1 per mile of range (-1 per 3 miles if using a spyglass). This differs from air and artillery observation (p. B243) in two ways: There is no modifier for lacking a map, since the fire control officer and the gunner are on the same ship, and the range is greater to reflect the greater size of the target being acquired.

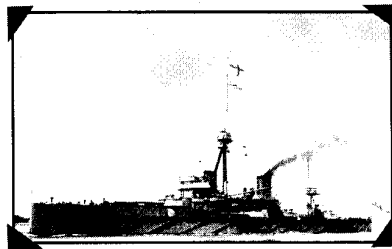

## NAVAL ORGANIZATION AND RANK

Ranks in the British navy for most of the 19th century followed those used on sailing ships. The titles are generally similar to those for 20th-century ranks:

Title	Rank
Admiral	8
Vice admiral, rear admiral	7
Post-captain	6
Commander	5
Lieutenant	4 or 3
Warrant officer	3 or 2
Petty officer	2 or 1
Seaman	rank 0

Despite verbal similarity, the meanings of these terms were significantly different. The legal terms of service in the navy varied drastically from rank to rank.

The only men on a warship who were "in the navy" in the modern sense - individually sworn to serve the state in whatever duties it might assign - were the commissioned officers (lieutenant and above). Their oaths permitted their reassignment from ship to ship, and such reassignment was the main way they advanced their careers. A commissioned officer started out as a lieutenant serving under another man's command. Ships of the line had from one to six lieutenants. A newly commissioned lieutenant might be the only lieutenant on a small ship or the least senior on a large one; each had advantages and disadvantages for working one's way up to first lieutenant of a large ship. An experienced lieutenant might be appointed to command a very small ship, such as a sloop; this was prestigious but did not actually increase rank (treat as rank 4).

The next step was "commander," an officer in charge of a larger ship that was not a ship of the line. Success in this role might bring promotion to post-captain, in command of a ship of the line. (Technically, only a post-captain was properly called a captain; other naval ships had commanders, and civilian ships had masters and mates.) A captain might command a fleet under the title of "commodore" without actual promotion (rank 6, brevet rank 7 or 8); if he was promoted, he became an admiral. The senior admiral of a fleet might be assisted by a vice admiral, in operational command of the line of battle, and a rear admiral, in command of the reserve.

*Continued on next page . . .*

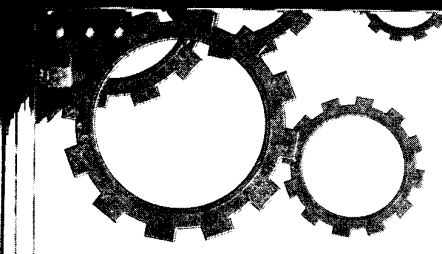

## NAVAL ORGANIZATION AND RANK (Continued)

Warrant officers were authorized to perform specific duties, normally on board a specific ship; their commitment was to those duties and not to the navy as a whole. When a ship went out of service, many warrant officers remained attached to her and responsible for her maintenance.

Below them were the petty officers, who served at the captain's pleasure and could lose their ratings at his will. Somewhat surprisingly, the midshipmen – young men destined to become commissioned officers – counted as petty officers; a midshipman who offended his captain could be “reduced to the ranks,” redefined as a common sailor.

Below all these different sorts of officers were common seamen, who stood watches, and idlers, such as the sailmaker's and carpenter's crews, who were exempt from watches. This distinction cut across higher ranks also; the sailing master might stand watches on a small ship, but the surgeon would not. Still lower were servants, mostly boys learning to be sailors, typically 10-15% of the crew; they had no Military Rank.

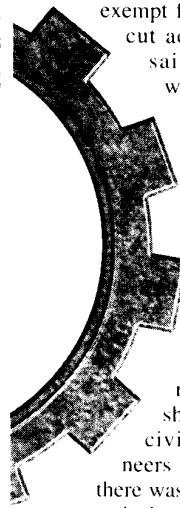

When the navy went over from sail to steam, the engineers occupied an anomalous position. On the very first steamships, they might not even be “in the navy” – the firm that built the ship's engines would supply a civilian specialist. When engineers were accepted into the navy, there was resistance to treating them as commissioned officers. Gradually engineering came to be accepted as a fourth specialty for officers, along with navigation, gunnery, and torpedoes.

In the same period, the navy adopted new procedures for recruiting, training, and assigning duties to sailors. Civilians were no longer liable to pressing, and sailors no longer moved between the navy and the merchant fleet. Under the old system, any loyalty a sailor felt was probably to his captain; under the new, sailors were expected to have a sense of obligation to the navy itself, just as officers did.

It takes 2d+5 seconds for the fire control officer to relay firing coordinates to the gunner by speaking tube, telephone, or telegraph. The Gunner roll is based on the average effective skill of all the gun crews; if the gun crews are all NPCs, they can be rated similarly to ground troops, as Raw (10), Green (11), Average (12), Seasoned (13), Veteran (14), or Elite (15). The roll is modified by four factors. First, add or subtract the margin of success or failure on the Forward Observer roll (a critical failure on Forward Observer means that there is no hope of the guns hitting anything). Second, if the ship has a fire direction center, apply a +2 modifier at TL5, or +3 at TL(5+1). Third, if the ship has a calculating engine able to run a fire direction program (this requires a Complexity 1 system, either a dedicated system at TL5 or an analytical engine at TL(5+1)), apply a +2 modifier. Fourth, apply range modifiers (p. B201). However, the range penalty is 10 less than usual (minimum 0), because the designated target is a fairly large area (this reduction assumes a target zone 100 yards across, comparable to the size of a capital ship). Note that weapon Accuracy does *not* affect this roll (but see the rules for corrected fire below).

If some shots in a salvo fail to hit the target, determine scatter for those shots. First determine the scattering range number; this is -10 added to the margin by which the Gunner roll failed (or simply -10 if the Gunner roll succeeded). Look this up in the Size and Speed/Range table on p. B201. Determine scatter direction as on p. B119; if more than one shot misses, assume they all scatter in the same direction.

*Example:* On a salvo of eight shells with effective Gunner skill of 14, the roll is 15. One shot hits the target; the other seven miss. The margin of failure is -1, so the scattering range number is -11; on the table on p. B201 this gives 150 yards.

On subsequent salvos, the fire control officer may correct fire. Repeat the Forward Observer and Gunner rolls, but with a bonus to effective Gunner skill of +4 on the first salvo, +8 on the second, and an added +2 for each further salvo, up to the Accuracy of the gun. If the Forward Observer rolls is a failure, the salvo just past is not observed; use the same effective Gunner skill as on the preceding salvo. Each salvo requires 2d+5 seconds for transmission of orders.

## THE GREAT GAME

“The great game” was Kipling's name for espionage, especially in India, Britain's most valuable possession and the target of Russian schemes (or so the British feared). In *GURPS Steampunk* the phrase includes espionage and covert operations all over the world.

In 1815, Britain had two professional intelligence organizations: the Secret Intelligence Service, founded by Sir Francis Walsingham, and the Decyphering Branch, founded by John Wallis. The Decyphering Branch was abolished in 1844, after political changes made the routine opening and copying of letters unacceptable. The Secret Intelligence Service concentrated on Irish rebels between 1815 and 1899. During the Crimean War in 1854, military attachés in British embassies began collecting foreign intelligence. The Intelligence Branch of the War Office was founded in 1873, and the Naval Intelligence Department in 1887. Both were small; the Intelligence Branch started out with only 27 staff members, including 10 civilian cartographers. The Foreign Office theoretically had intelligence responsibilities, but was not systematic about pursuing them.



On the Continent, most governments had larger intelligence agencies; Bismarck's aide Wilhelm Stieber led the way in giving Prussia a professional intelligence service. The United States, on the other hand, was even less systematic about intelligence than Britain. During the Civil War, the Union's main intelligence agency was Pinkerton and Company, a private detective firm (see pp. WWii84-85).

Espionage in the 19th century is largely the work of amateurs. British merchants and tourists travel all over the world; their accounts of their travels provide information useful to the government and the military. In addition, a military officer engaged in espionage can easily invent a cover story, blending into the crowds of travelers. For example, Robert Baden-Powell toured Dalmatia as a butterfly collector and brought out plans of a fortress disguised as a sketch of a butterfly. Beginning in the 1880s, travel grants of £600 (\$3,000) are available for officers in the Division of Military Intelligence. Officers volunteering to collect intelligence during their travels are cautioned against claiming any connection with the intelligence services, sending mail to the army, or carrying away notes or sketches. In fact, official policy is to "prove" that they were operating without official approval by punishing their indiscretions.

Intelligence has three principal functions: collecting information, analysis, and reporting. The essential skill for the third is Writing, and for the second Intelligence Analysis. The first draws on more varied skills, but Acting is important, as it can be used to simulate innocent motives. Knowledge of foreign languages is a major asset. Spies must operate on their own; there are not enough resources to support team assignments. In fact, being rich enough to pay for information and help is a major asset in a spy's career.

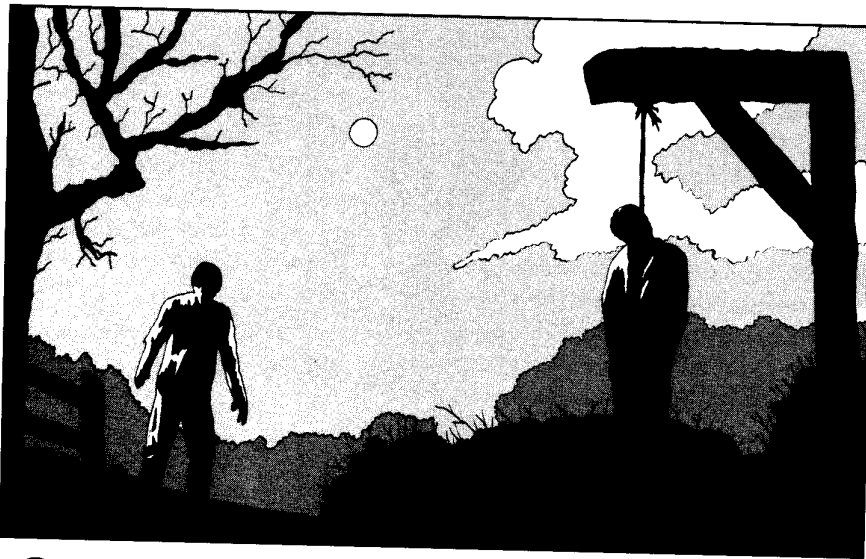

## CRIMINAL INVESTIGATION

The 19th century saw the emergence of systematic criminal investigation. In part, this was a response to the changing political climate, especially in the English-speaking countries; legal restrictions on methods of law enforcement – the right to a trial, the requirement for search warrants based on probable cause, and the legal prohibition of torture – meant that the authorities actually had to support criminal charges with evidence.

## CODES AND CRYPTOGRAPHY

Interest in codes and ciphers was common in the 19th century. Poe's story "The Gold Bug" gives a clear explanation of breaking letter substitution codes on the basis of letter frequencies, for example. Babbage and his friend Wheatstone made a hobby of breaking and inventing ciphers.

The telegraph created increased demand for encryption systems; people sending telegrams were aware that their words would be read at each end of the line. In 1845, two codebooks for telegraphic messages were published, in which various words and phrases were represented by index numbers. It soon became evident that telegraph operators were likely to make mistakes in transmitting such strings of characters; later codebooks relied more on actual words to represent other words.

In most European countries, encryption was allowed only to governments at first, with each country having its own rules; in the United States, where the telegraph system was privately owned, there were no such restrictions. In 1865, a conference of 20 nations set up the International Telegraphic Union, under whose rules encryption was legal for everyone.

Transmission of encrypted messages was slower and less accurate; see p. B55. Telegraph companies charged for such messages by the letter, not by the word, and at a higher rate. Even so, there were many customers for such messages. Governments, especially their military and diplomatic branches, sent many of them; the French government established a Bureau de Chiffre in the 1890s to crack other nations' codes. Much the same techniques were still in use in the 1940s, when they stimulated the early development of electronic computers.

Encryption also had financial applications: Western Union set up a system for secure transmission of funds by telegram in 1872, the original e-cash. (Stock exchanges were also heavy users of telegraphy; one of Thomas Edison's early inventions was an improved ticker tape machine.) The skills of Cryptanalysis and Cryptography are available to characters with suitable backgrounds; anyone may learn Cryptology, though it has Mathematics as a prerequisite.

## BERTILLON STATISTICS

In 1879, a young clerk working for the French prefect of police proposed that identification of criminals could be aided by systematic measurement and recording of the sizes of various parts of their bodies. Trained in statistics, Alphonse Bertillon (1853-1914) worked out that any one body measurement had one chance in four of failing to distinguish two people chosen at random. By taking 11 measurements (height, span of outstretched arms, head length and breadth, right ear length and breadth, trunk length, span of the outstretched arms, length from elbow to fingertip, length of middle and ring fingers, and length of the left foot), he proposed to reduce the chance of error to one in 4,194,304. His system came into widespread use as a method of identification in the last two decades of the century; the police accumulated millions of records. Anyone who deals with the police before 1900 may encounter this practice.

The technique of bertillonage is tricky; it defaults to (late TL5 or TL(5+1)) Forensics -1, Anthropology-2, or Criminology-3 (if the criminologist subscribes to theories of crime as evolutionary regression). It can be raised as an Average maneuver; Manual Dexterity helps. A person who cannot use numbers cannot perform bertillonage. Success produces exact measurements; failure produces one slightly inaccurate measurement per point of mismatch; critical failure produces hopeless inaccuracy. A simplified system with only five measurements, used by departments with a shortage of trained personnel, has a +5 modifier; it can eliminate a suspect but not positively identify one.

## PUNISHMENT

At the start of the 19th century, over 200 crimes were punishable by death, ranging from murder to sodomy to stealing an item worth 5s. (\$1.25) from a shop. The reform movement of the early 19th century brought an end to most death penalties, and by 1850 only treason, piracy, murder, and arson of a dockyard or arsenal still carried the death penalty. The penalty was carried out by hanging. Hangings were conducted in public until 1868 and were viewed as entertainment – a well-publicized hanging might draw tens of thousands of spectators. Last speeches to the crowd were popular in folklore, ballads, and novels.

The first replacement for hanging was transportation, or shipping criminals overseas. Botany Bay, in Australia, was a prison colony, and 140,000 convicts were sent there between 1810 and 1852. As gold mining and sheep ranching attracted voluntary colonists, they voiced objections to the introduction of more convicts and the system was abolished.

*Continued on next page . . .*

Until 1880, police work relied primarily on informers and *agents provocateurs*. Ex-criminals were recruited to denounce other criminals to the police.

The major skill for a detective in this period is Acting, Administration, Research, or Streetwise. The famous American agency Pinkerton and Company (see pp. WWii84-85) made its reputation with such methods, not only in fighting crime but in anti-union activities and Civil War intelligence work. Collecting portraits of criminals was a Pinkerton techniques that later became standard.



From 1880 to 1900, Alphonse Bertillon's anthropometric methods (see sidebar, this page) provided the standard method for identifying criminals. Bertillon also systematized

photography, establishing the now standard full face and profile "mug shot." Photographs taken by these standards can be used to identify criminals with a Vision roll by the witness (+2 for Eidetic Memory 1, +4 for Eidetic Memory 2, with modifiers for the original viewing conditions); photographs by less exacting standards impose at least a -2 penalty. Finally,

Bertillon was a pioneer in systematic collection of evidence at a crime scene; he is known to quote the complaint of Sherlock Holmes comparing the police to a herd of buffalo. The skill of Forensics becomes available to characters after 1880.

In 1900, Scotland Yard adopted fingerprinting for identification. Police departments throughout the world followed their example, collecting the fingerprints of arrested men, though it is a long time before the general public accepts being fingerprinted. From 1900 to 1914, an adventurer without a criminal past would be unlikely to have fingerprints on record, though if he came under suspicion for other reasons fingerprints might confirm his guilt.

The technique of comparing wear patterns on bullets to match a bullet to a gun was not used during the Age of Steam; microscopes for this purpose were not designed until after the Great War.



# HEALING AND MEDICINE

In the 19th century, British medical practice was divided up in a way foreign to 20th-century assumptions. There were no “general practitioners”; medicine and surgery were separate professions. Apothecaries made up a third medical profession. The three differed in the tasks they performed and also in social background, physicians having the highest Status and apothecaries the lowest.

Other countries do not necessarily follow the British pattern. In the United States, for example, medical licensure was abolished under Andrew Jackson as an undemocratic interference with individual liberty; for decades thereafter, anyone who likes could set up as a doctor – physician, surgeon, or both.

## Physicians

Medicine is a learned profession; many physicians are university graduates. There was a Royal College of Physicians long before 1815. Physicians treat the wealthy and the middle classes. Treatment means asking questions, taking a case history, and writing out instructions to be carried out by family or servants. Physical examination is limited to taking the pulse and looking at a urine specimen. Training emphasizes reading classical texts in the original Latin. A physician will have the skills of Physiology, Physician, Diagnosis, and Latin. Many physicians also have scientific interests; the skill Naturalist is common.

By this period, many diseases had been described and distinguished; a physician actually had a fairly good chance of diagnosing a common disease. Later in the period, such diagnostic tools as the stethoscope and the thermometer came into use, giving the standard +1/2 TL bonus.

Medical treatment relied heavily on toxic inorganic compounds. Whatever therapeutic effect they have depends on their being more toxic to the disease organism than to the patient. For such treatments, a successful Physician roll results in the patient’s regaining one point of HT over and above natural healing, while losing one point of HT from toxicity; the toxicity wears off automatically over the next 24 hours. On a critical success, there is no toxicity. On a failure, the toxic effects are experienced with no curative effect. On a critical failure, the patient loses 1d HT from toxicity with no curative effect. A physician who chooses heroic treatment may give multiple doses, increasing both curative effects and toxicity by the same factor. The patient is allowed an HT roll to resist toxicity, unless the physician makes a critical success (no toxic effects) or a critical failure (too high a dose to resist).

## Surgeons

Surgeons have lower social standing than physicians; surgery may be highly skilled work, but it counts as manual labor, not quite respectable. Over the course of the 19th century, surgeons improve their social position, notably with the founding of the Royal College of Surgeons in 1843. Surgery is taught by apprenticeship, like any craft. A surgeon of this period will have the skills of First Aid and Surgery, but not Physician, and Physician is not a prerequisite for Surgery.



## PUNISHMENT (Continued)

Imprisonment, which replaced it, was a new idea. Accused offenders awaiting trial had been imprisoned for many centuries, but prison as a punishment in itself only went back to the 18th century. Early prisons tended to be chaotic, with large numbers of prisoners under minimal supervision. Reformers in the early 19th century went to the other extreme, favoring solitary confinement of all prisoners and requiring total silence. Solitary confinement was retained for troublesome prisoners long after the first versions of the present-day prison system were established in the late 1800s.

Many prisoners were sentenced to hard labor; from 1818 to 1898 this was performed on the treadmill, a muscle engine powered by walking steadily upward. British prisoners spent 6 hours a day on the treadmill; Australian convicts spent 40 minutes out of each hour from sunrise to sunset, climbing the equivalent of 3 miles. Labor on the treadmill was dreaded, as it was both physically difficult and tedious. Less physically fit prisoners were assigned to making oakum (tar-impregnated rope for caulking wooden ships).

Corporal punishment was abolished in the armed services in the 1850s. It remained in use in schools, typically in the form of caning, though blows to the hand were sometimes used.



## DRUGS

Clergymen and reformers in the 19th might worry about drugs, and writers from Thomas de Quincey to Aleister Crowley made money from lurid accounts of their use, but they were sold without prescription to anyone who wanted them, over the counter or by mail. In 1839, when the Chinese Empire tried to shut down the opium trade, the British Empire declared war to enforce the right of civilized men to sell drugs – and picked up Hong Kong in the process. Only a backward, half-civilized country such as China, most people thought, would try to interfere in the opium trade.

Such interference became widespread in the 20th century: the United States restricted opiates in 1914 (the Harrison Act), alcohol in 1919 (the Prohibition Amendment), and marijuana in 1937 (the Marijuana Tax Act). Many heroes of 20th-century popular culture, from the Untouchables to the Lensmen, were enforcers of drug laws. Such heroes are an anachronism in the 19th century, when a popular literary character's regular use of cocaine is a minor eccentricity, comparable to his playing the violin.

The century sees two technical developments that make surgery safer and more effective: anesthesia, which removes the pressure to operate quickly, allowing more careful technique, and antisepsis, which makes it more likely that wounds will heal without infection. Before these innovations, surgery is terrifying – painful, risky, and often ineffective, resorted to only in desperation. To reflect this, use the following rules.

First, surgery always inflicts bodily injury. The basic level of injury is 1d for minor surgery such as dental extractions or lithotomy (removing stones from the bladder); 2d for amputation; 3d for amputation at the shoulder or hip or internal surgery. On a successful Surgery roll, count one of the dice as an automatic 1; on a critical success, damage is 1 point per die. On a critical failure, roll damage normally and double the result. If anyone attempts brain surgery, treat it as minor surgery, but on any failure, apply the usual  $\times 4$  multiplier for brain hits.

Surgery skill is modified by the patient's behavior and the depth of the incision. There is no modifier if the patient is completely still; -1 if the patient makes small involuntary movements; -3 if the patient is held down by force; -6 if the hold fails and the patient moves violently. There is no modifier for superficial surgery; -1 for oral surgery; -2 for work in an incision into the body; -3 for work with probes.

For a patient to hold still requires a Will roll; patients with High Pain Threshold are exempt from this requirement. Success by 4 or more points allows a patient to remain completely still; any success limits movement to small involuntary movements. A surgeon may take the precaution of having a patient held down, but if the patient makes his Will roll, there is no penalty

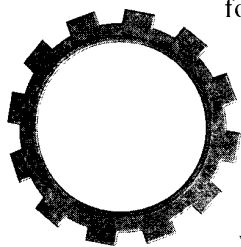

for being held. Modifiers are -2 for surgery on the torso; -4 for surgery on the head, hands, or groin; -5 if the patient has Low Pain Threshold; +1 if the patient has taken opium or alcohol; +5 if the patient has taken stupefying amounts or is unconscious. Hypnotism (see *Magnetism*, p. 104) can also be used, with +1 to Will for each point by which the Hypnotism roll succeeds; after a critical success, no Will roll is required.

Holding a patient still requires assistants with total ST at least 3× the patient's ST.

Surgical procedures before anesthesia are measured in minutes. Assume 1d minutes for the first Surgery roll. If it fails, further rolls may be attempted at -1 per attempt; each roll takes 1 minute, causes 1 hit additional damage, and requires an additional Will roll for the patient to hold still.

Following surgery, a First Aid roll is required to dress the surgical wounds; First Aid is also used to treat superficial combat injuries. Treat this as TL4 First Aid; see pp. B127-128.

With the development of anesthesia and sterile technique, surgical outcomes improve. The rules on p. B56 may be used. Alternatively, the rules above may be used, with the following modifiers: first, a Physician roll allows the patient to be anesthetized (see p. 93); second, with slower and more careful technique, any success causes 1 point damage per die, and a critical success causes no damage; third, use TL5 First Aid (see pp. B127-128).

### Apothecaries

Apothecaries were originally merchants who dealt in herbs and medicinal substances. When a physician prescribed a drug, it was the apothecary who prepared it for the patient. But since physicians were expensive, many people went directly to the apothecary and asked for recommendations; even rich people called in apothecaries rather than physicians when a servant was ill. So apothecaries did a great deal of prescribing and some diagnosis. It was not legal for them to charge for such services, only for the drugs they actually sell. An apothecary will have the skills of Herbalism and Chemistry; treat Herbalism as a form of Physician.

For available drugs and their effects, see *The Chemist's Shop* (pp. 91-93).

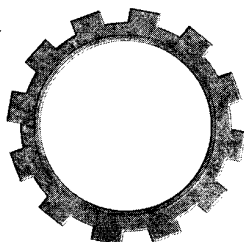
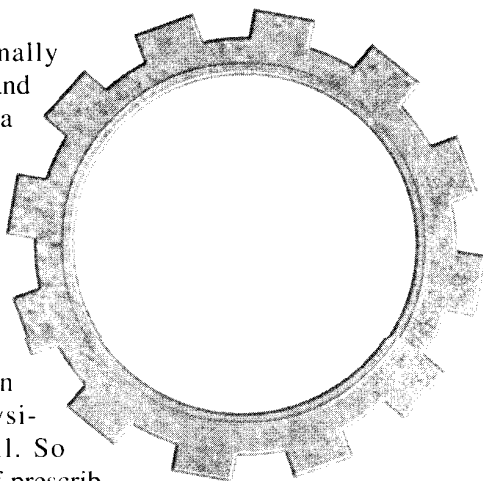

### NURSING

Many casualties of 19th-century battles were not killed immediately, but suffered wounds that became infected, leading to slow, nasty deaths. Early in the century no systematic efforts were made to provide supportive care to the wounded. Under these conditions, a roll against Physician skill may improve a wounded man's condition, but the wounded man does not get +1 to HT rolls, and typically faces a -1 to -5 penalty.

In 1854, in response to reports of medical conditions in the Crimean War, the British government recruited Florence Nightingale to organize better care for wounded soldiers. Taking three other nurses and £30,000 (\$150,000), she traveled to the Black Sea. Despite bitter opposition from army doctors, she was able to push through such radical ideas as giving the wounded clean clothes and beds. Within a year she was running the hospital. Her reforms created lasting changes in military medicine and hospital care and helped create the profession of nursing. Dorothea Dix played a similar role during the American Civil War, organizing the first nursing corps in 1861.

In this period, nurses typically had a strong, almost religious sense of vocation and duty. They defined their own role as one of subordination to doctors; nurses followed orders, regardless of their personal feelings, and do not presume to practice medicine or have medical opinions. But an experienced nurse, especially one with administrative powers, has always had ways of bringing doctors into line.

### MEDICINE AND MORTALITY RATES

During the 19th century, life expectancy at birth rose from about 35 to about 45. Medicine and surgery had little to do with this. Anesthesia and antisepsis improved a patient's chances of surviving surgery, but most people didn't die of conditions that surgery could help with. Medical treatment for infectious diseases, the major killers for most of the period, was ineffective at best. In fact, one of the major developments in medical science was the statistical evaluation of therapeutic methods, as in a study that showed that death rates from pneumonia were 1 in 5 with bleeding, 1 in 5.5 with doses of tartar emetic (an antimony compound), and 1 in 13 with simple bed rest. The concepts of self-limiting diseases and supportive treatment emerged during this period and at least stopped doctors from killing patients with heroic doses of heavy metals.

*Continued on next page . . .*





## MEDICINE AND MORTALITY RATES

(Continued)

Improved public sanitation was a major contributor to longevity. Sewer systems, street cleaning, and safe drinking water reduced contagion and the prevalence of illness, starting in the 1840s. By the 1850s most cities had boards of health, organized locally in English-speaking countries and nationally elsewhere. Bathing was revived between 1850 and 1875, at least for the upper and middle classes, whose servants could do the heavy work a bath required before indoor plumbing. Pasteur's work on bacteriology gave a scientific justification for new standards of cleanliness that were already emerging.

The collection of social statistics, pioneered by Babbage, Quetelet, and others of their era, led to the emergence of epidemiology. Disease carriers such as Typhoid Mary, unsafe wells, and other sources of contagion could be identified and removed. This was undertaken on a large scale during the construction of the Panama Canal. The first attempt by the French in the 1880s cost 25,000 lives, largely to yellow fever. The American attempt that completed the canal in the 1900s lost fewer than 5,000, thanks to American health officers who wiped out the mosquitoes that carried the disease.

Immunization became available for an increasing number of diseases. Doctors already gave smallpox vaccinations, and scientists developed vaccines against anthrax and rabies. After 1905, mortality from childhood infections began to fall.

Finally, nutrition improved during the 19th century. The energy content (calorie values) of foods could be measured, using thermodynamic apparatus. Carbohydrates, fats, and proteins were recognized as energy sources, and the concept of trace nutrients began to emerge. Beriberi, rickets, and scurvy were identified as deficiency diseases and chemists began trying to isolate and then to synthesize the "vitamines" that prevented them. The concept of a balanced diet was developed. Aside from preventing deficiency diseases, better nutrition led to overall improvements in health.

A referee who wants to allow moderately enhanced abilities in this background may base them on advanced nutrition during childhood. Arguably, this is even realistic. Improvements in diet have made successive generations taller and stronger over the course of the 20th century. Athletic records have increased steadily as well, though training may have more to do with this than diet.

## INVENTING THE PAST

Science fiction is based on imaginary future technology. If steampunk is a genre that recreates 19th-century science fiction, why does *GURPS Steampunk* have so many rules for technology that actually existed in the 19th century?

In the first place, the real technologies create a baseline for the imaginary technologies. Verne's lunar cannon and Kipling's bulkhead vacuum airships were imaginary improvements on real guns and real airships; knowing something about the reality makes the fantasy more understandable.

In the second place, the 19th century was a time of incredibly rapid progress in many technologies. One decade's wild visions were a later decade's engineering manuals. In 1893, Kipling had the Scots engineer McAndrew say, "There's be the loco-boiler next an' thirty mile an hour!" – a speed that was reached in less than a decade. Simply speeding up the pace of invention is one strategy for creating a steampunk world. Anything from airships a decade early to computers a century early can provide the basis for a world of advanced technology.

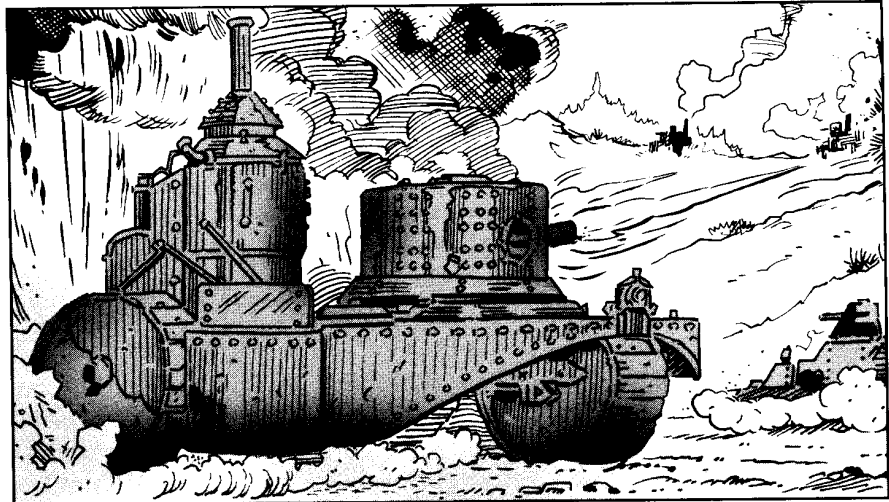

Conversely, carrying older technologies forward into the future, or having future technologies created in their image, can produce a steampunk effect. The naval history of the Age of Steam had such atavisms, from a brief revival of ancient Greek ramming tactics to the long survival of close-range naval battles, even when naval guns had ranges of several miles. A similar anachronistic effect could be produced by having heavily armored airships doing battle in the style of naval ships, especially if their maneuvers remained two-dimensional. So, in the third place, knowing how those older technologies worked can provide a model for such steampunk technologies.

One basis for this persistence of older technologies can be the delayed invention of later technologies. For example, in a world without internal combustion, heavier-than-air flight might be unable to replace the airship. A world without liquid-fuel rockets might get itself into space with solid-fuel rockets, huge magnetic cannon, or gravity screens.

For any of these strategies, the key point is the same: The real 19th century was an age of wonders. Recapturing its sense of wonder at its own creations is what steampunk is all about.

# CHAPTER 5 MARVELOUS INVENTIONS

*In its case it lay compactly,  
Folded into nearly nothing;  
But he opened out its hinges,  
Pushed and pulled the joints and hinges  
Till it looked all squares and oblongs,  
Like a complicated figure  
In the second book of Euclid.*

*— Lewis Carroll,  
“Hiawatha’s Photographing”*



The driving force behind steampunk is the technology: the wonderful devices that were never actually invented, but might have been. This chapter details some historical technology,

and also some that only exists in fiction and the imagination. In addition, it offers guidelines for working out new miraculous inventions based on the science of the Age of Steam.

## THE INVENTOR

How can steampunk characters create advanced devices? *GURPS* offers several paths, with different game implications. Some require that the inventor have an appropriate advantage.

Devices at the campaign TL can be built using the ordinary inventing procedure (see pp. B186-187 for a simple treatment or pp. VE201-202 for an expanded treatment).

The Gadgeteer advantage confers the ability to create new devices at higher TLs with a skill roll (see pp. CI121-122). Gadgets must be rated for complexity as well as TL; these ratings determine the time needed to develop the gadget, the skill penalty, and development and production costs, which must be paid before the first gadget of a given type can be made. The gadgeteer needs at least one technical skill at a high level and substantial wealth. Alternatively, a gadgeteer with a Patron or an appropriate job may obtain funding, but any resulting gadget will be someone else's property! This option is normally used to create new devices in play, but at GM discretion, the "trading points for equipment" option (p. CI17) may be used to pay the costs of having built a gadget before play begins.

A cinematic extension of this approach is the quick gadgeteering system (pp. CI123-124). This requires the 50-point Gadgeteer advantage. Time required is drastically reduced, and a roll against an appropriate technical specialty can make scrounged parts available at minimal cost.

All these options let characters build new devices during play. In contrast, the Invention advantage (p. 44) allows a

character to *have invented* one advanced device before the start of play, bypassing skill rolls and costs, but does not permit further inventions in play. (It *is* legal, though expensive, to have both Invention and Gadgeteer!)

The inventor's TL is normally the same as the campaign TL. However, someone from a less advanced society – for example, a tribal or peasant society encountering Europeans – may have the Primitive disadvantage. Someone from a small enclave of higher technology may have the High Technology advantage (p. Ci26), usually +1 TL [20 points] for someone from a TL(5+1) enclave in a TL5 society. If the whole society is TL(5+1), ordinary invention can produce TL(5+1) gadgets.

An inventor from a lower TL can try to duplicate a device from a higher TL. First apply the penalty for working with a higher TL to figure out what the device does and how it works; then apply the penalty for working with a lower TL to duplicate it with available technology. The combined modifiers are as follows (see p. B185):

TL Difference	Combined Modifiers
1	-6
2	-13
3	-20

All these rules assume that the character builds his own gadgets. An Unusual Background (a gadgeteer or high-tech friend) or a Patron may also be a source of advanced equipment.

## NEW MATERIALS

The 19th century saw a great increase in the use of iron as a structural material. Blast furnaces, fueled by coke, produced several tons of cast iron per day. Ironclad warships, railroads, and building frames were all made of cast iron. Steel and wrought iron were more expensive and less widely used, as the crucibles where they were produced could hold no more than 100 lbs. of raw material. Techniques for producing larger amounts of steel were developed in 1846 by William Kelly and in 1856 by Henry Bessemer and by Wilhelm and Friedrich Siemens. Commercial production of steel in lots of up to 15 tons began in 1864 in the United States. By 1900, steel replaced iron in most uses. The electric-arc furnace, invented in 1878, produced special alloy steels in lots of several tons.

Manganese, tungsten, chromium, nickel, and vanadium became valuable as additives.

Aluminum was isolated in 1825 by Hans Christian Oersted. Aluminum production used potassium and was extremely costly; aluminum cost \$260 a pound. In 1854, Henri Deville developed a process using sodium that lowered the cost tenfold and set up a factory near Paris. In 1886, Charles Hall and Paul-Louis-Toussaint Héroult invented electrolytic processes, which are still in use. Manufacturing plants were founded at Niagara Falls and in Switzerland and Norway, all sources of hydroelectric power. Aluminum had less structural strength than steel, but its lightness and resistance to corrosion made it a major industrial material.

## THE SKYSCRAPER

In 1851, James Bogardus constructed the first building with a cast-iron frame, a five-story factory in New York. The weight of

the building was supported by columns rather than by the building's walls; that is, buildings were *framed* rather than *frameless*.

As the price of urban land rose, buildings were erected on the smallest possible lots, their walls close together or even touching. Cast iron frames and the hydraulic elevator led to multistory buildings in which many tenants occupied the same lot. The first skyscraper was the Equitable Life Assurance Society Building, erected 1868-1870 in New York and standing 130 feet tall. By the century's end, buildings were hundreds of feet tall, creating the high skylines of the modern urban landscape. Architects such as Louis Sullivan struggled to find designs and ornamentation for structures taller than the ancient world had ever envisioned.



## PRIME MOVERS

The Industrial Revolution began with wind and water power. Most of New England's textile factories, for example, were built alongside rivers that supplied water power. But as industry developed, factories relied more and more on a new power source: the steam engine. Steam developed first in Britain, where wood was in short supply – factories turned to Britain's vast reserves of coal, resulting in the first fossil fuel economy. Factory managers faced with the choice of running their factories with human laborers, draft animals, water, wind, or steam began measuring energy efficiency and choosing cost-effective technologies.

### WATER POWER

The water mill remained an important source of power throughout the 19th century. In 1750 Europe had 1 mill per 29 people, and nearly all remained in use for the next hundred years. Water power also played a large role in the industrialization of North America.

Water mills have three main forms: *undershot*, in which the water hits the wheel low down, turning it in the direction of stream flow; *overshot*, in which the water hits at the top of the wheel and propels it forward, forcing the bottom of the wheel to turn against the stream; and *vertical*, in which the water hits one side of a horizontal wheel and turns it on a vertical shaft. The cost and the power output of any wheel depend on its diameter. The maximum diameter for a wheel in normal practice is 16'.

#### Water Wheel

Type	Cost	Power Output
Overshot	\$7.50	0.225
Undershot	\$7.50	0.045
Vertical	\$10	0.075

Cost is dollars per foot of wheel diameter; power output is kW per foot of wheel diameter. An overshot wheel needs a fall of water through the full height of the wheel, either naturally occurring or produced by a watercourse. A typical watercourse is at least 100' long per 1' of wheel diameter. Constructing a watercourse doubles the cost of a wheel.

Water turbines (see p. 72) come into use during TL5; they can be supplied from a free-flowing stream, as long as there is a height difference to provide potential energy.

In terms of the *GURPS Vehicles* rules for collisions (pp. VE166-167), skyscrapers are 10-60 stories high, with breach capacity equal to length in yards, multiplied by width in yards, multiplied by the number of stories, divided by 4. Typical wall materials are concrete (DR 4, 60 HP), light brick (DR 6, 40 HP), heavy brick (DR 6, 60 HP), light stone (DR 8, 90 HP), and heavy stone (DR 8, 180 HP). An attack that causes damage equal to the building's HP, after its DR is subtracted, creates one breach. The creation of a number of breaches equal to the breach capacity causes the building to collapse, inflicting damage equal to (HP + DR)/4 dice per story of building height on everyone in it. A DX roll avoids damage, with a +4 modifier for anyone in the basement.

### WIND POWER

Windmills also remained in use during the 19th century. Many farms, for example, irrigated their fields with water pumped by windmills.

A windmill's basic attribute is the diameter of its blades, equal to twice the length of a single blade. To find the cost in dollars, square the diameter in feet and divide the result by 2. Windmills are normally built in locations with reasonably steady winds; daily average power for a windmill, in kW, can be estimated as the square of the diameter in feet, divided by 1,000.

### CLOCKWORK

Springs and other forms of clockwork were the first energy banks. They were still in use throughout TL5. Realistic clockwork weighs 0.25 lbs. per kW, occupies 1 cf per 50 lbs., and costs \$1 per lbs. In a cinematic campaign, advanced clockwork with highly efficient springs can store much more energy: weight 0.025 lbs. per kW, volume 1 cf per 50 lbs., cost \$2.50 per lbs.

### STEAM ENGINES

The basic stages in the development of steam technology are as described on pp. VE82-83:

Early *low-pressure* steam engines such as Watt's original model were in use before 1815.

*Forced-draft* steam engines, operating at higher pressures, were first experimented with in 1840 and came into regular use in 1850.

*Compound* engines, such as the triple-expansion engine, could have a varying number of stages of expansion. Two-cylinder engines were experimented with in 1854 and generally adopted in 1874. Triple-expansion engines followed in 1885, and German shipbuilders produced quadruple-expansion engines from 1897 through 1906. Such engines were mainly used on ships or in factories.

*Steam turbines*, burning coal or oil, came into use at the same time as quadruple-expansion engines and replaced them after a decade. Oil had clear advantages over coal: it gave more energy for the same weight and it did not require human stokers. No one actually built a sextuple-expansion steam engine, but someone might have tried had the turbine not been developed.

## MARVELOUS INVENTIONS



## Steam Engine

Type	Weight if Output Is		Cost	Fuel Used	TL
	under 5 kW	5 kW or more			
Low-pressure	200×kW	(100×kW)+500	\$0.01	0.12C/0.48Wd	5
Forced-draft	150×kW	(75×kW)+375	\$0.02	0.08C/0.32Wd	5
Double-expansion	112×kW	(56×kW)+280	\$0.03	0.04C/0.16Wd	5
Triple-expansion	100×kW	(50×kW)+250	\$0.04	0.03C/0.12Wd	5
Quadruple-expansion	94×kW	(47×kW)+235	\$0.05	0.02C/0.08Wd	5
Sextuple-expansion	88×kW	(44×kW)+220	\$0.07	0.015C/0.06Wd	5+1
Steam turbine	125×kW	(25×kW)+500	\$0.05	0.02C/0.10FO	5+1

Use the power output of the engine in kW to determine its weight in pounds. There are two columns for use in calculating weight, one for engines with output under 5 kW, the other for larger engines. Divide weight by 50 to find volume in cf. Cost is in dollars per pound of engine weight. Fuel use is per kW, in cf per hour for coal (C) or wood (Wd), and in gallons per hour of fuel oil (FO). If two fuels are listed, the engine can use either.

### Upgrades

The performance of steam engines could be enhanced by giving them more stages of expansion. As with upgrading a computer, the result would not be an optimized design but might be cheaper than a new engine. Here is how to compute the characteristics of an engine with an increased number of stages of expansion: First, determine the total fuel consumption before expansion. Assume that after expansion, the engine still uses the same amount of fuel but gets more power out of it. Figure the increased power output for the new engine type. Use this to compute the variable part of the weight for the new engine type. The weight of the modified engine is the original fixed weight plus the new variable weight; the cost of the upgrade is the new variable weight times the cost factor for the new engine type.

For example, a 10-kW double-expansion engine weighs  $56 \times 10 + 280 = 840$  lbs., costs \$25.20, and burns 0.4 cf/hr. of coal. If it is refitted as a triple-expansion engine, that same coal consumption will produce 13.3 kW. The new engine will weigh  $50 \times 13.3 + 280 = 935$  lbs.; the cost of the upgrade will be  $655 \times \$0.03 = \$19.65$ . In contrast, a new triple-expansion engine would have weighed 905 lbs. and cost \$27.15.

Any upgrade requires an Engineering roll at -2 per stage of expansion added, followed by a series of Mechanic rolls to get the engine working properly (see the rules on bugs, pp. VE201-202).

### Solar Steam Engines

The solar steam engine provides power to spacecraft or space stations, using the intense solar radiation in outer space as a heat source. This system has two parts. One is equivalent to a standard steam engine, but with weight, volume, and cost reduced 20% and with no fuel consumption. The other is one or more mirrors. Mirror area needed per kW is 200 sf for an expansively worked engine, 100 sf for a double-expansion engine, 66.7 sf for a triple-expansion engine, 50 sf for a

quadruple-expansion engine, 33.3 sf for a sextuple-expansion engine, or 50 sf for a steam turbine. Mirrors weigh 1 lbs. and cost \$0.04 per sf. Mirrors must be mounted on masts; maximum area of mirrors equals (average mast length) squared  $\times$  number of masts/2. Compute crewmen needed to align the mirrors as for sails (p. VE75).

### Boiler Explosions

Steam engines could be pushed beyond their rated maximum power output. This dramatically increased the chances of a breakdown or explosion. When the engineer in a steam-punk campaign says, "Captain, the engines canna take much more o' this!" he's warning of a potential disaster.

Power may be increased above the rated maximum in 10% increments. Increased power allows increased speed, according to the following table.

### Steam Power Beyond Rated Maximum

Power Increase	Water Speed Increase	Air/Ground Speed Increase
10%	3%	5%
20%	6%	10%
30%	9%	14%
40%	12%	18%
50%	14%	22%
60%	17%	26%
70%	19%	30%
80%	22%	34%
90%	24%	38%
100%	26%	41%

This increase requires an Engineer roll at -1 per 10% increase. On a critical success, the engine functions perfectly. On an ordinary success, it functions safely but needs immediate maintenance afterward. On an ordinary failure, it breaks down – gears jam, pipes burst, or the like. On a critical failure, it explodes. On an 18, the explosion is immediate; on any other critical failure, there is a moment's warning, during which bystanders may dive for cover – or a heroic engineer may try to prevent the explosion with an Engineer-5 roll, with no opportunity to avoid injury if the attempt fails.

If a pipe leaks or bursts, escaping steam causes 1d-1 burn damage to a randomly chosen victim in the engine room. He may attempt to dodge the steam.



If a steam engine explodes, it causes concussive damage equal to 6d per 50 kW for a low-pressure engine, 6d per 10 kW for any expansively worked engine, or 6d per 2 kW for a turbine. The full damage is applied to anyone within 2 yards of the engine. For each 2 yards out, divide damage by 4. Superheated steam also scalds anyone close enough to suffer concussive damage, inflicting 1d-1 damage from burns. Fragmentation damage occurs in hexes adjacent to the engine on a 17 or less, with a -1 modifier per hex farther out; damage is 1d per hex (equivalent to being in a scrap yard).

## PRIMARY BATTERIES

Before the storage battery was invented, chemists made primary batteries – nonrechargeable wet or dry cells that produced electricity by an irreversible chemical reaction. Realistically, primary batteries can operate small devices but produce too little energy to power a vehicle. In a cinematic campaign, they may be more powerful.

### Batteries

Type	Weight	Cost	TL
Lead-acid	0.03	\$0.0125	5
Primary	0.012	\$0.025	5
Lead-acid	0.025	\$0.025	(5+1)
Primary	0.01	\$0.05	(5+1)
Advanced primary	0.001	\$0.15	(5+1)

Weight is weight in pounds per kW of stored energy. Divide weight by 200 to obtain volume in cf for lead-acid batteries, or by 100 for primary batteries. Cost is in dollars per pound of battery weight.

The “advanced primary” battery is a cinematic design and should not be used in technologically realistic campaigns. The GM may assume that it is really a cold fusion device or something else that 19th-century science can’t fully explain, discovered by trial and error.

### Comparative Power Transmission Systems

Technology	Conversion System Cost	Transmission Cost	Wasted Power	TL
Millwork, Wooden	–	\$25/mi.	750%/mi.	2
Millwork, Steel	–	\$60/mi.	500%/mi.	5
Telodynamics	–	\$5/mi.	50%/mi.	5
Hydraulics	\$60	\$10/mi.	25%/mi.	5
Pneumatics	\$135	\$5/mi.	10%/mi.	5
Steam Pipes	–	\$15/mi.	25%/mi.	5
Electricity, Low-Voltage	\$150	\$2.50/mi.	10%/mi.	5
Electricity, High-Voltage	\$225	\$5/mi.	1%/mi.	5
Electricity, High-Voltage	\$225	\$5/mi.	0.05%/mi.	(5+1)
Beamed Power	\$750	–	line of sight	(5+1)

In this table, costs are per kW of peak capacity. Since these systems are in fixed locations, weights and volumes are not specified. Power lost in transmission is equal to (Wasted Power × Distance in Miles) × Power Delivered; add delivered power to lost power to obtain the required size of the power plant. Millwork normally delivers power over fractions of a

## POWER TRANSMISSION

Generating power was one thing; making it available where it was needed was another. The traditional technology, millwork, used massive rotating shafts to drive gears and belts and lost huge amounts of power over any distance. Factories were laid out to place equipment as close as possible to the power source; convenience and safety were secondary considerations. The second half of the 19th century saw experiments with several systems for power transmission before electricity emerged as the winner.

Telodynamics used thin wire ropes supported by pulleys several feet in diameter, moving at speeds averaging 50 mph. This system had the advantage of being driven directly by a mechanical prime mover – no pumps or generators were needed.

Hydraulics used mechanical power to pump water into pipes at high pressure. The system was expensive, and could not be operated at high speeds due to friction, but it was and still is used for specialized applications where massive force may be needed.

Pneumatics used air rather than water as the fluid medium – it was less expensive and could be controlled with more flexibility.

Steam pipes had to be substantially heavier than pneumatic tubes. Even with insulation they lost power as the steam cooled.

Electricity required substantial investment in generators and motors. In the long run, though, it paid off not only in lower costs per mile but in much smaller power losses. Alternating current, which could be stepped up to higher voltages with transformers, increased the range still further, making long-distance power transmission possible for the first time.

Beamed power was never made practical, despite Tesla’s heroic efforts – but in a retrotech setting, it might have been (see *Gernsback*, pp. AE107-125).

mile, and power losses must be taken into account at such distances. Losses from other power transmission systems over less than 0.5 mi. can be disregarded. Beamed power has negligible losses in transmission, but can only reach to the horizon. Retransmission can extend this, but with a 5% loss for each retransmission.

For example, a factory needs 20 kW to operate its equipment. The nearest electric power plant is 5 miles away, with TL5 high-voltage transmission (approximately 1,000 volts). The power loss is  $1\% \times 5 = 5\%$  or 1 kW. The power plant must supply 21 kW to keep the factory running.

Using transmitted power usually requires some form of motor at the location where the power is used.

### Motors

Type	Weight if output is		Cost	TL
	under 5 kW	5 kW or more		
Water turbine	$20 \times \text{kW}$	$4 \times \text{kW} + 80$	\$0.25	5
Air turbine	$6 \times \text{kW}$	$0.6 \times \text{kW} + 27$	\$0.25	5
Steam turbine	$25 \times \text{kW}$	$5 \times \text{kW} + 100$	\$1	(5+1)
Electric motor	$20 \times \text{kW}$	$4 \times \text{kW} + 80$	\$0.02	5
Electric motor	$10 \times \text{kW}$	$2 \times \text{kW} + 40$	\$0.02	(5+1)
Beamed power receiver	$15 \times \text{kW}$	$3 \times \text{kW} + 60$	\$100	(5+1)
			$+ \$0.10 \times \text{kW}$	

Volume is 1 cf per 50 lbs. Cost is per pound, except for a beamed power receiver, for which cost is per kW. A beamed power receiver must be combined with an electric motor to produce mechanical work; by itself it only produces electric current. Hydraulic, pneumatic, electrical, or beamed power systems can power movable tools or mechanical men. Only

electrical or beamed power systems are useful as power sources for vehicles.

## HOW MUCH POWER DO WE NEED?

Working out the power requirements of various machines and installations in detail would involve complexities enough to fill a book; ask any engineer who has to do it for real! Here are some rules of thumb for power requirements.

### Power Requirements

Power Requirements	Item
0.05 kW	Hand tool, small appliance
0.5 kW	Farm machine, large appliance, machine shop
5 kW	Mill, water pump (20 cf/min.)
50 kW	Small factory, elevator, large building environmental system
500 kW	Large factory

*Note:* The output rate for the water pump assumes a column 35 feet high, the maximum under 1 atmosphere pressure. For shorter columns, increase output proportionately; a 7-foot column could have 100 cf/min. for the same power.

## VEHICLES

Scientific romances of the 19th century are filled with radical new vehicles. Verne's name for the genre was *voyages extraordinaires* – "extraordinary journeys." Many steampunk campaigns include such vehicles, and some center around them. This section offers designs both for real 19th-century vehicles and for possible or imaginable advanced models.

The vehicles presented here were worked out using *GURPS Vehicles*. However, *GURPS Steampunk* introduces a new, more user-friendly format for vehicle stats, which are explained in the *Vehicle Stats Key* on the following page. Any of these vehicle designs may be used as is, or as a model for the creation of new Age of Steam vehicles.

Prices in *GURPS Steampunk* are in 19th-century United States dollars. When creating new vehicles, work out the design with *GURPS Vehicles* and divide the price by 20; the result will come reasonably close to the historical price. Note that the systems and components described in *GURPS Steampunk* are already in 19th-century dollars – to use them in vehicle design, multiply prices by 20, and then divide the final price by 20 to return to 19th-century dollars.

Vehicles may have components more advanced than actual Victorian engineering permitted. TL6 components from *GURPS Vehicles* may be used, if compatible with a campaign's technological assumptions. They will be considered to be TL(5+1). More advanced components, if they are allowed, should have doubled weight, volume, and cost – this applies to arm motors and leg and ornithopter drivetrains. (Arm motors should also have Bad Grip, so they actually

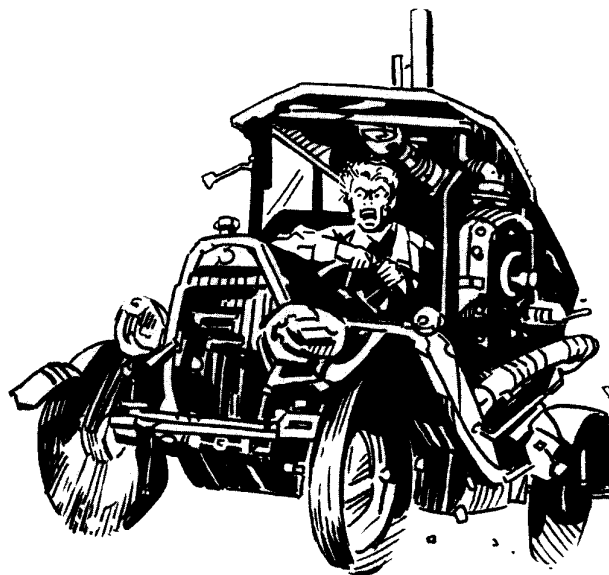

have standard cost but -4 DX.) Treat structure and armor as TL5, but assume that the Advanced option is available and that the Expensive option is the usual one at TL(5+1). The weight factor for Advanced metal armor is 0.5.

In general, vehicles labeled TL5 actually existed, but TL(5+1) vehicles are "what ifs." The exceptions are identified in the vehicle descriptions.

## SIMPLE STEAMPUNK VEHICLE DESIGNS

GMs who prefer to avoid the complexities of vehicle design may also use a simplified approach: Choose a TL6-7 vehicle that might plausibly have an Age of Steam analog. Double its weight and volume and divide its cost by 10. Multiply top speed by 0.71 for land vehicles, 0.86 for water or underwater vehicles, or 0.79 for air vehicles; multiply stall speed by 1.26 for air vehicles; multiply acceleration by 0.5 for space vehicles.

## VEHICLE STATS KEY

In the following vehicle descriptions, the subassemblies where components are located are abbreviated Gas, Opn, Sub, Sup, Trk, Tur, Whl, for Gasbag, Open Mount, Substructure, Superstructure, Track, Turret, and Wheel respectively, followed by a number if there are multiple subassemblies of the same type. (Arm, Body, Leg, Mast, Skid, and Wing are spelled out.) Faces of subassemblies are coded as F for front, RL for right and left, B for back, T for top, and U for underbody. In the initial list of subassemblies, the number following each subassembly is the targeting modifier to hit it.

Fuel is listed by amount (cf of solid fuel or gal. of liquid fuel), type, and fire number. Occupancy is coded as CCS, NCS, or RCS for cramped, normal, or roomy crew stations; CS, NS, and RS for cramped, normal, and roomy passenger seats; CSR, NSR, or RSR for passenger standing room. An X indicates an exposed position. C indicates crew members without a specific crew station. Unless otherwise specified, cargo space holds 20 lbs. per cf.

Armor is shown by PD/DR values. Armor may be coded as ablative (A), nonrigid (N), or wood (W); if it is not coded, assume metal armor.

Weapons are shown by location and facing. Ammunition listings include all rounds stored on the vehicle. Each entry ends with the targeting modifier provided by the vehicle's support systems for direct fire. For full weapon statistics, see the weapons tables on pp. 88-89.

Statistics are vehicle dimensions in feet; payload (including fuel, crew, cargo, and ammunition) and full loaded weight; volume in cubic feet; price in 19th-century U.S. dollars; overall HT and location hit points; top speed in mph, acceleration and deceleration in mph/second, MR in G, and SR, a margin of safety for failed control rolls. To determine turning radius (p. B139), square the vehicle's current speed and divide by  $(40 \times MR)$ . The letters g, w, u, a, s, and t indicate ground, water, underwater, air, space, and time. Other statistics appropriate to a given type of vehicle are listed at the end.

## LAND VEHICLES

Land vehicles range from the vehicles that actually revolutionized Victorian travel – the bicycle and the locomotive – to fanciful experimental steam vehicles. Several designs for steampunk “mecha” are provided; see pp. ME108-109 for another treatment of this topic.

### Bicycle, TL5

The bicycle brought personal mobility to the working class, enabling a rider to travel under his own power as fast as a horse-drawn carriage. Bicycle mechanics played a key role in the development of the automobile and airplane. This model has the now standard two equal-sized wheels and hollow steel frame. The armor is an open frame (2-in-6 chance of protecting against thrusting attacks or small missiles); the wheels are not armored but have wheelguards (no protection from below; 4-in-6 chance of protecting against attacks from other directions). The rider occupies a cycle seat, and the cargo an open rack. The performance statistics assume a ST 12 rider; the drivetrain can transmit up to ST 15.



*Subassemblies:* Body -2, Wheels -4.

*Power & Propulsion:* 0.3-kW muscle engine w/ wheeled drivetrain.

*Occupancy:* 1 XCCS      *Cargo:* 0.5 cf

#### Armor

*Body:* 3/5

*Whl:* 3/5

#### Statistics

*Size:* 3'x0.5'x5'      *Payload:* 210 lbs.      *Lwt.:* 269 lbs.

*Volume:* 0.75 cf      *SizeMod:* -2      *Price:* \$6.30

*HT:* 7      *HP:* 3 [Body]      2 [Whl]

*gSpeed:* 16      *gAccel:* 1      *gDecel:* 10      *gMR:* 1.5      *gSR:* 2  
Very High GP. Off-Road Speed 2.

A variant design, the tandem “bicycle built for two,” was celebrated in the popular song “Daisy.” The performance statistics for this model assume combined ST 20; the drivetrain can transmit up to ST 25.

*Subassemblies:* Body -1, three Wheels -3.

*Power & Propulsion:* 0.5-kW muscle engine w/ wheeled drivetrain.

*Occupancy:* 2 XCCS      *Cargo:* 1.0 cf

### Armor

Body: 3/5

Whl: 3/5

### Statistics

Size: 3'x0.5'x8' Payload: 420 lbs. Lwt.: 517 lbs.

Volume: 1.32 cf SizeMod: -1 Price: \$11.40

HT: 7 HP: 5 [Body] 2 [Whl]

gSpeed: 15 gAccel: 1 gDecel: 10 gMR: 1.5 gSR: 2  
Extremely High GP. Off-Road Speed 0.

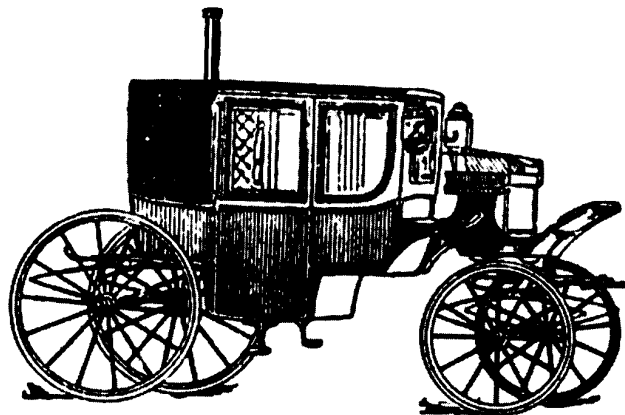

### Steam Carriage, TL5

Early automobile designers experimented with a variety of power sources: electric batteries, internal combustion, and steam. The model described here is literally a horseless carriage. It has an open wooden body with seats for four (including the driver) and luggage space underneath, with separate standing room at the back for a stoker; the body and engine are mounted on a heavy steel frame. The wheels are not armored but have wheelguards (no protection from below; 4-in-6 chance of protecting against attacks from other directions).

*Subassemblies:* Body +3, four Wheels +1.

*Power & Propulsion:* 5-kW double-expansion steam engine w/ wheeled drivetrain.

*Fuel:* 1.5 cf coal, 7.5 hours.

*Occupancy:* 1 XRCS, 1XC, 3XRS Cargo: 10 cf

### Armor

Body: 2/2W

Whl: 2/2W

### Statistics

Size: 4.5'x5.5'x9' Payload: 1,275 lbs. Lwt.: 4,675 lbs.

Volume: 141 cf SizeMod: +3 Price: \$215.00

HT: 12 HP: 450 [Body] 45 [Whl]

gSpeed: 18 gAccel: 1 gDecel: 10 gMR: 0.75 gSR: 4  
Extremely High GP. Off-Road Speed: 0.

### Steam Locomotive, TL5

Steam engines were the power source for nearly all 19th-century rail transport. This steam locomotive is a fairly typical design, with eight wheels, four of which supply tractive force. Fuel is carried in a 15-ton coal car where the fireman (i.e., stoker) rides; the performance statistics take its weight into account. The armor is an open frame (2-in-6 chance of protecting against thrusting attacks or small missiles); the wheels are not armored but have wheelguards (no protection from below; 4-in-6 chance of protecting against attacks from other directions).

*Subassemblies:* Body +5, eight Wheels +3.

*Power & Propulsion:* 360-kW forced-draft steam engine w/ wheeled drivetrain.

*Fuel:* 300 cf coal, carried externally; 10.4 hours.

*Occupancy:* 2 RCS

### Armor

Body: 3/5

Whl: 3/5

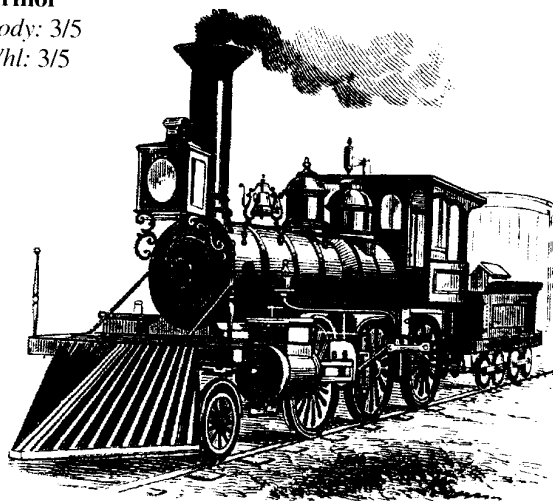

### Statistics

Size: 9'x7'x30' Payload: 400 lbs. Lwt.: 56,855 lbs.

Volume: 1,675 cf SizeMod: +5 Price: \$2,310.00

HT: 12 HP: 4,500 [Body] 375 [Whl]

gSpeed: 70 gAccel: 1 gDecel: 10 gMR: 0.25 gSR: 5  
Off-Rail Speed: 0.

### Land Ironclad, TL5

This massive war vehicle is a late TL5 "what if"; it has one TL(5+1) innovation, a tracked drivetrain, in an experimental form. It is manned by two gunners and four loaders, a driver, a commander, a stoker/mechanic, and a general utility crewman whose duties range from running messages to opening a hatch and shooting at enemy soldiers who are getting too close. Environmental control technology makes the interior tolerable, though noisy. A plow blade gives +1 for each 2d of collision damage.

*Subassemblies:* Body +5, top Turret +4, two Tracks +4.

*Power & Propulsion:* 400-kW triple-expansion steam engine w/ tracked drivetrain.

Fuel: 100 cf coal, 8.33 hours.

Occupancy: 2 C, 1 NCS, 1 CCS, 2 NCS [Tur], 4 CCS [Tur]

Cargo: 10 cf

Armor	F	RL	B	T	U
Body:	4/20	4/20	4/20	3/10	3/6
Tur:	6/40	5/30	4/20	3/10	-
Trk:	3/14 (all locations)				

### Weaponry

2 x 105mm Naval Gun [Tur:F] (50 Solid each) +3

### Equipment

Body: Periscope, 5', no magnification.

### Statistics

Size: 8'x12'x24' Payload: 11,300 lbs. Lwt.: 81,900 lbs.

Volume: 1,640 cf SizeMod: +5 Price: \$7,450.00

HT: 10 HP: 2,220 [Body] 780 [Trk] 1,140 [Tur]

gSpeed: 30 gAccel: 2 gDecel: 20 gMR: 0.25 gSR: 6  
Very High GP. Off-Road Speed: 24.

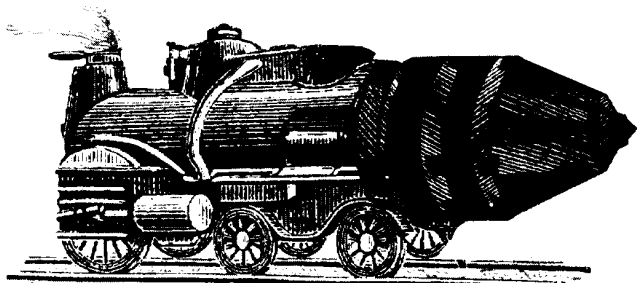

## Steam Mole, TL(5+1)

The steam mole is a cinematic vehicle, based on a super-borer. It can drill 100' per hour through solid rock, creating a tunnel with cross-sectional area 72 sf. (Multiply speed x2 in soft rock, x3 in clay, or x4 in sand or soil.) Two drivers and three stoker/mechanics share three bunks. Life support is good for 15 man-days. A mini-workshop provides for basic repairs. Lead-acid batteries can keep the life system and workshop going for 4 hours. The armor is an open frame (2-in-6 chance of protecting against thrusting attacks or small missiles), except on the superstructure. The wheels are not armored but have wheelguards (no protection from below; 4-in-6 chance of protecting against attacks from other directions).

Subassemblies: Body +6, Superstructure +4, 12 Wheels +4.

Power & Propulsion: 250-kW steam turbine w/ 10-kW all-wheel wheeled drivetrain.

Fuel: 360 cf coal, 72 hours.

Occupancy: 1 C, 1 CCS [Sup], 1 CS [Sup] Cargo: 100 cf

Armor	F	LR	B	T	U
Body:	3/10	3/10	3/10	3/10	3/10
Sup:	4/20	4/20	4/20	5/30	-
Whl:	3/10 (all locations)				

### Equipment

Body: Super-borer, 120 cf/minute.

### Statistics

Size: 10'x10'x90' Payload: 10,200 lbs. Lwt.: 177,300 lbs.

Volume: 4,395 cf SizeMod: +6 Price: \$13,000.00

HT: 9 HP: 3,975 [Body] 1,125 [Sup] 225 [Whl]

gSpeed: 4 gAccel: 1 gDecel: 10 gMR: 0.125 gSR: 5  
Extremely High GP. Off-Road Speed: 0.5.

## Iron Horse, TL(5+1)

Intended to preserve the military usefulness of cavalry in a world of mechanized warfare, the iron horse is built around a legged drivetrain controlled by a small dedicated analytical engine. The rider occupies a saddle and steers primarily with his legs, using his arms to operate an autoloading rifle in a limited-rotation open mount, protected by a gun shield. The iron horse can be set to walk, trot, gallop, or even jump. The rider carries a small hatchet for refueling the wood-burning engine. The iron horse has a built-in hitch and can exert a tractive force of 6,750 lbs.

Subassemblies: Body +1, four Legs -1, Open Mount -2.

Power & Propulsion: 3-kW double-expansion steam engine w/ legged drivetrain.

Fuel: 2.5 cf wood, 5.2 hours.

Occupancy: 1 XCCS

### Armor

Body: 3/10

Opn: 3/10

Leg: 3/10

### Weaponry

.47 Heavy Rifle [Opn:F] (400 Solid) +1

### Statistics

Size: 7.5'x3'x8' Payload: 360 lbs. Lwt.: 3,440 lbs.

Volume: 29 cf SizeMod: +1 Price: \$1,460.00

HT: 12 HP: 135 [Body] 30 [Leg] 12 [Opn]

gSpeed: 16 gAccel: 5 gDecel: 20 gMR: 1.25 gSR: 2  
Low GP. Off-Road Speed: 13.

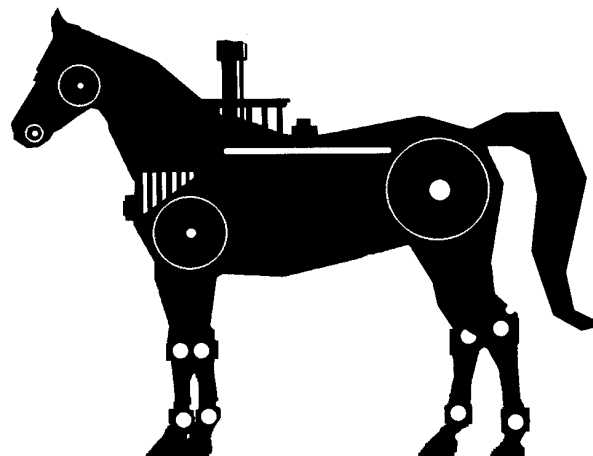



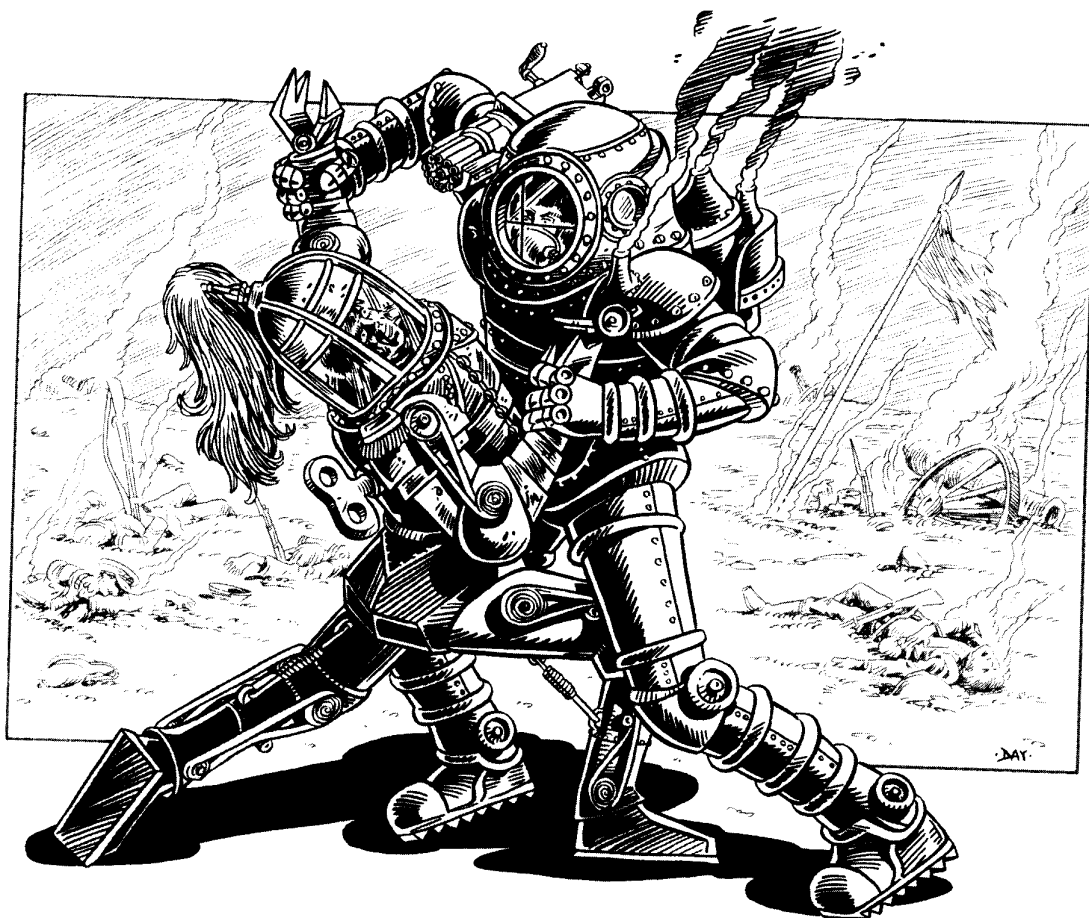

### Clockwork Armor, TL(4+1)

This version of a battlesuit could be a Renaissance genius's prototype or a Victorian tinkerer's toy; either form is a technological "what if." It fits a wearer weighing 128-160 lbs. A man with a crank can wind it up in 10 hours of steady work, which supplies power for 2.75 hours of use. The arms are strong enough to wield a very heavy weapon.

*Subassemblies:* Body +0, top Turret -2, two Arms -2, two Legs -1.

*Power & Propulsion:* 7,200-kWs advanced clockwork w/ 0.5-kW legged drivetrain.

*Occupancy:* 1 CCS

#### Armor

Body: 3/10

Tur: 3/10

Arm: 3/5

Leg: 3/5

#### Equipment

Arm: Arm motor, poor coordination (-4), ST 20.

#### Statistics

Size: 7.5'x2.5'x2.5'    Payload: 200 lbs.    Lwt.: 1,290 lbs.  
Volume: 8.8 cf    SizeMod: +0    Price: \$2,570.00

HT: 12    HP: 51 [Body]    10 [Tur]    20 [Arm]    20 [Leg]

gSpeed: 7    gAccel: 4    gDecel: 20    gMR: 2.5    gSR: 1  
Low GP. Off-Road Speed: 6.

### Battlesuit, TL(5+1)

This steam-powered battlesuit could be worn by the elite infantry of an alternative 20th century. It fits a man weighing 140-175 lbs. It provides air conditioning for enhanced comfort and endurance and a built-in gas mask. Combat capabilities come from a gun on a fixed mount atop the helmet and from the strength of the arms, which can carry heavy firearms or melee weapons.

*Subassemblies:* Body +0, top Turret -2, two Arms -2, two Legs -1, top Open Mount -3 [Tur].

*Power & Propulsion:* 1-kW quadruple-expansion steam engine w/ 0.55-kW legged drivetrain.

*Fuel:* 0.15 cf coal, 7.5 hours.

*Occupancy:* 1 CCS

#### Armor

Body: 3/10

Tur: 3/10

Arm: 3/5

Leg: 3/5

#### Weaponry

15mm Helmet Gun [Opn:F]  
(22 Solid) +2

#### Equipment

Tur: Gunsight. Arm: Arm motor, bad grip (-4), ST 20.

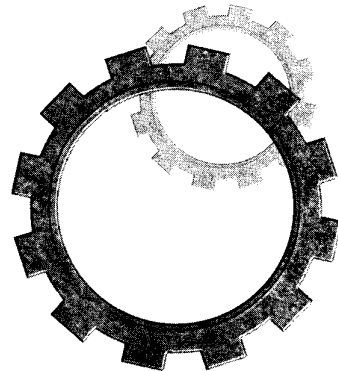
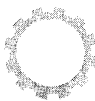

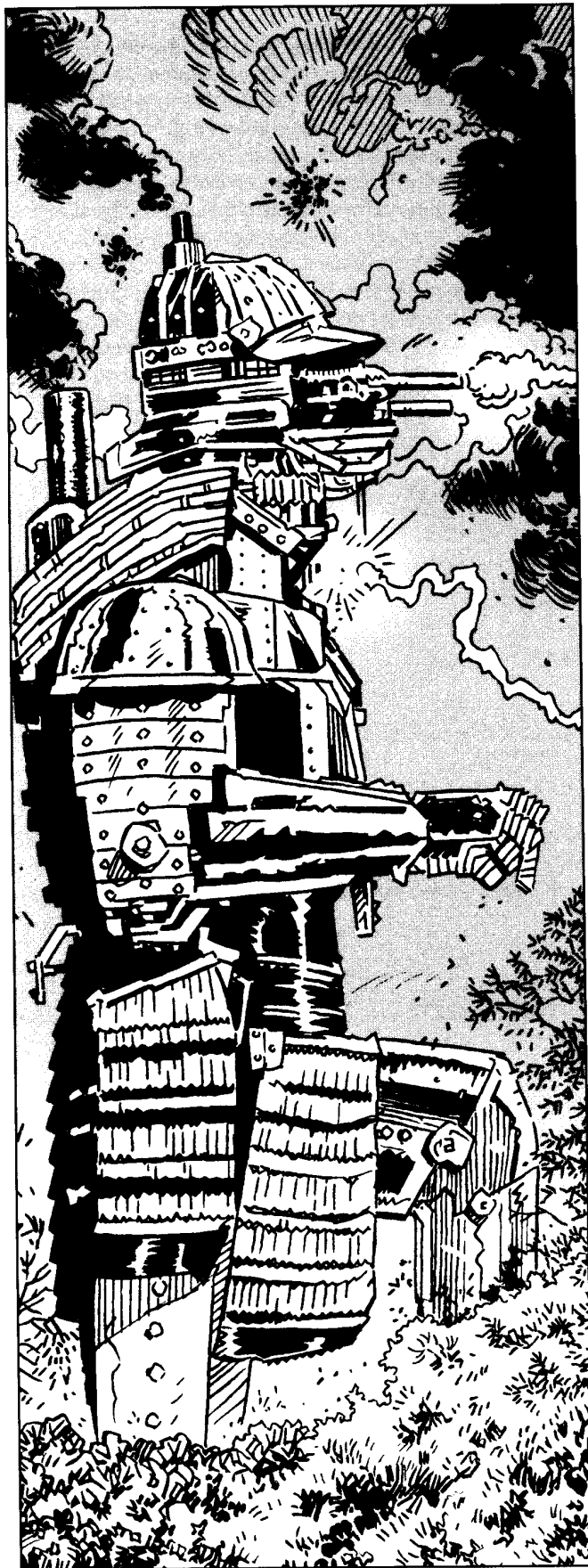

### Statistics

Size: 7.5'×3.5'×2.5' Payload: 209 lbs. Lwt.: 896 lbs.  
 Volume: 8.3 cf SizeMod: +0 Price: \$2,110.00

HT: 12 HP: 46 [Body] 11 [Tur] 20 [Arm] 22 [Leg] 5 [Opn]

gSpeed: 9 gAccel: 4 gDecel: 20 gMR: 2.5 gSR: 1  
 Very Low GP. Off-Road Speed: 9.

An alternative, heavier model is also available. Only a few of its features differ:

### Armor

Body: 4/20

Tur: 4/20

Arm: 3/10

Leg: 3/10

Lwt.: 1,044 lbs. Price: \$2,260.00

gSpeed: 8

Low GP. Off-Road Speed: 6.

### O-Daisuchimu, TL(5+1)

The "honorable big steam" applies the long-range gunnery techniques of the Russo-Japanese War to land combat. Its operation is entirely mechanical, including steam analytical engines that calculate trajectories (Complexity 1, IQ 4) and move its limbs (Complexity 2, IQ 5, DX 9). It is manned by a gunner in the turret and a driver and engineer in the body. An extra 80 cf of open space provides standing room for a commander if one is assigned. The engineer cannot repair the engines from inside the craft – a workshop with special cradles is needed.

Subassemblies: Body +3, top Turret +2, two Arms +1, two Legs +2.

Power & Propulsion: 100-kW triple-expansion steam engine w/ 95-kW legged drivetrain.

Fuel: 20 cf coal, 6.7 hours.

Occupancy: 2CCS, 1CCS [Tur]

Armor	F	RL	B	T	U
Body:	4/40	4/40	4/40	4/40	4/40
Tur:	6/80	5/60	5/60	4/40	–
Arm:	4/40 (all locations)				
Leg:	4/40 (all locations)				

### Weaponry

1.375 caliber Cannon [Tur:F] (100 Solid, 25 HE each) +2

### Equipment

Tur: Complexity 1 dedicated analytical engine with Fire Direction. Arm: Arm motor, bad grip, ST 50.

### Statistics

Size: 30'×10'×10' Payload: 2,400 lbs. Lwt.: 37,700 lbs.  
 Volume: 527 cf SizeMod: +4 Price: \$16,900.00

HT: 12 HP: 1,580 [Body] 600 [Tur] 720 [Arm] 540 [Leg]

gSpeed: 17 gAccel: 9 gDecel: 20 gMR: 1.5 gSR: 1  
 High GP. Off-Road Speed: 8.

## WATER VEHICLES

Ship design in the 19th century progressed rapidly, with periods of wild experimentation – one decade's futuristic visions were a later decade's blueprints. Most of the water vessels presented here really existed. The watercraft that fascinated the 19th-century imagination was the submarine; the version below could fit into a cinematic Age of Steam.

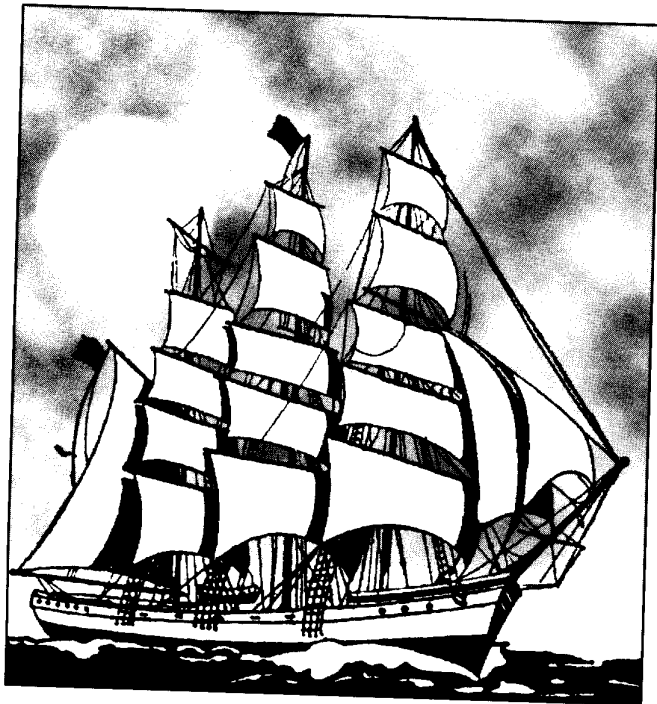

### Clipper Ship, TL5

Sailing ship design reached its height *after* the invention of the steamship. The clipper ship, a predominantly American design able to transport cargo at remarkably high speeds, came into use after 1843. Clipper ships were three-masted, with full-rigged sails and good hydrodynamic lines. The top speed assumes a fresh breeze. This version is based on the American ship *Sea Witch*. The body provides space for a master, two mates, and up to 10 passengers in 7 cabins, and for 12 sailors, a steward, and a cook in bunks.

**Subassemblies:** Body +8, two Masts +2, one Mast +1.

**Power & Propulsion:** 10,837.5 sf full-rigged sails.

**Occupancy:** See above      **Cargo:** 25,000 cf

Armor	F	RL	B	T	U
Body:	2/4	2/4	2/4	–	2/2

#### Statistics

**Size:** 22'×33'×178'      **Payload:** 505,400 lbs.      **Lwt.:** 580,186 lbs.  
**Volume:** 36,080 cf      **SizeMod:** +8      **Price:** \$4,420.00

**HT:** 7      **HP:** 4.875 [Body]      210 [Mast1]      258 [Mast2]  
 108 [Mast3]

**wSpeed:** 19      **wAccel:** 0.7      **wDecel:** 0.5      **wMR:** 0.05      **wSR:** 4  
**Flotation:** 1,865,760 lbs.      **Draft:** 6.7'

### Steam Junk, TL5

The Chinese built vessels propelled by paddle wheels before 1000 A.D., powered by men on treadmills. This "what if" craft substitutes a low-pressure steam engine, invented by a Chinese genius or bought, salvaged, or copied from a Western design. As part of a pirate fleet, it normally travels by sail, but uses its engines to overtake merchant craft, preferably during a calm when its targets can only maneuver by paddling. Its steam hoses can be used to repel boarders (burn damage 1d-1, effective range 5 yards); other weapons are the option of the GM or the crew – repeating crossbows and rockets for picturesqueness, cannon for effectiveness. The captain has a cabin in the superstructure; the crew of 14 sleep in hammocks. Cargo is carried in the open interior, which is heavily compartmentalized to limit flooding.

**Subassemblies:** Body +6, top Superstructure +4, two Masts +1.

**Power & Propulsion:** 3,025 sf full-rigged sails; 330-kW low-pressure steam engine with paddle wheel.

**Occupancy:** See above      **Cargo:** 2,250 cf

Armor	F	RL	B	T	U
Body:	4/24 W	4/24 W	4/24 W	–	4/24 W
Sup:	3/10 W	3/10 W	3/10 W	3/10 W	–

#### Statistics

**Size:** 7.5'×17'×66'      **Payload:** 69,750 lbs.      **Lwt.:** 183,420 lbs.  
**Volume:** 6,017 cf      **SizeMod:** +6      **Price:** \$5,000.00

**HT:** 8      **HP:** 2,937 [Body]      659 [Sup]      94 [Mast1]      66 [Mast2]

**wSpeed:** 13 (sail)/10 (steam)      **wAccel:** 0.7 (sail)/0.3 (steam)  
**wDecel:** 1      **wMR:** 0.05      **gSR:** 4

**Flotation:** 335,900 lbs.      **Draft:** 4.2'

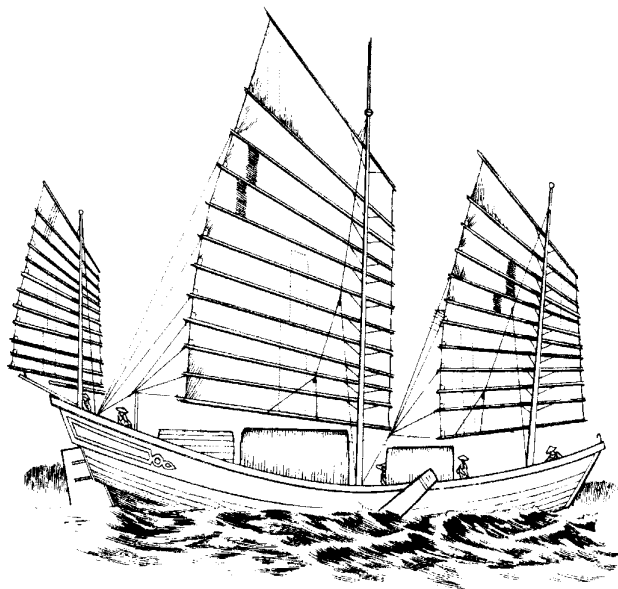

## H.M.S. Devastation, TL5

As the first deep-sea warship powered exclusively by steam, the *Devastation*, launched in 1873, was a prototype for generations of battleships. The abandonment of sail and the limitation of armament to four muzzle-loading guns in two full rotation turrets fore and aft allowed reduction of her complement to 358 officers and men. Between the turrets was a hurricane deck from which she was commanded; a 100' mast rose from this to provide a lookout station giving an 8-mile horizon. The hull is heavily compartmentalized to reduce flooding. For improved stability, the *Devastation's* deck was only a few feet above sea level; in effect, she was a seagoing monitor.

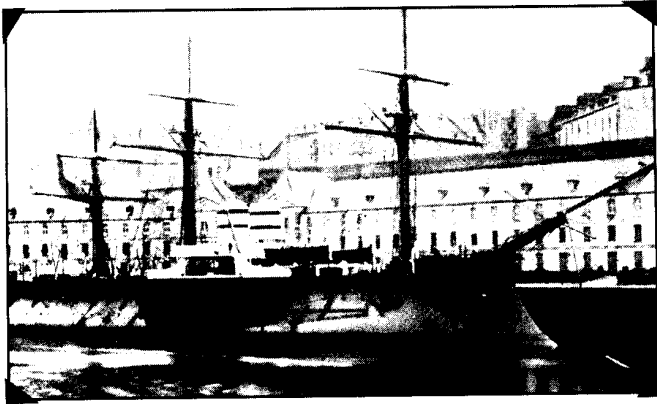

**Subassemblies:** Body +10, top Superstructure +8 (breast-work), Superstructure +7 (hurricane deck), two Turrets +6, Mast +2.

**Power & Propulsion:** 2 × 2,500-kW forced-draft steam engine with screw propeller.

**Fuel:** 81,000 cf coal; 405 hours.

**Occupancy:** See above      **Cargo:** 20,000 cf

Armor	F	RL	B	T	U
Body:	4/320	4/480	4/320	4/120	4/80
Sup1:	4/450	4/450	4/450	4/200	—
Sup2:	4/65	4/65	4/65	4/65	—
Tur:	4/500	4/500	4/500	4/250	—

### Weaponry

2 × 12" Naval Gun [Tur1:F] (120 HE)

2 × 12" Naval Gun [Tur2:F] (120 HE)

### Equipment

Sup2: 6 ship's boats; 2 cranes.

### Statistics

**Size:** 26'×62'×285'      **Payload:** 5,289,600 lbs.

**Lwt.:** 20,899,200 lbs.      **Volume:** 527,320 cf

**SizeMod:** +10      **Price:** \$1,807,190.00

**HT:** 6    **HP:** 103,408 [Body] 23,506 [Sup1] 16,200 [Sup2]  
7,654 [Tur] 258 [Mast]

**wSpeed:** 11    **wAccel:** 0.05    **wDecel:** 0.2    **wMR:** 0.02    **wSR:** 8  
**Flotation:** 22,642,568 lbs. **Draft:** 22'.

## Turbinia, TL5

The *Turbinia* was a late TL5 prototype built by Charles Parsons to demonstrate the superior performance of steam turbines. Operation requires a helmsman and three stoker/mechanics. The *Turbinia* is not designed to carry cargo, but has space for passengers, small cargo items, or ballast. After three years of trying to interest the British navy in his ship, Parker showed up at the Diamond Jubilee naval review and steamed rings around the queen's fastest warships – an illegal but successful publicity stunt. Date of launch: 1894.

**Subassemblies:** Body +6.

**Power & Propulsion:** 3 × 520-kW steam turbine with screw propeller.

**Fuel:** 225 cf coal, 7.2 hours.

**Occupancy:** 1 XRCS, 3 C.      **Cargo:** 250 cf

### Armor

Body: 3/10

### Statistics

**Size:** 9'×9'×100'      **Payload:** 17,000 lbs.      **Lwt.:** 96,000 lbs.

**Volume:** 4,400 cf      **SizeMod:** +6      **Price:** \$10,700.00

**HT:** 12      **HP:** 4,845 [Body]

**wSpeed:** 31    **wAccel:** 5    **wDecel:** 0.25    **wMR:** 0.05    **wSR:** 3  
**Flotation:** 211,200 lbs. **Draft:** 4.2'.

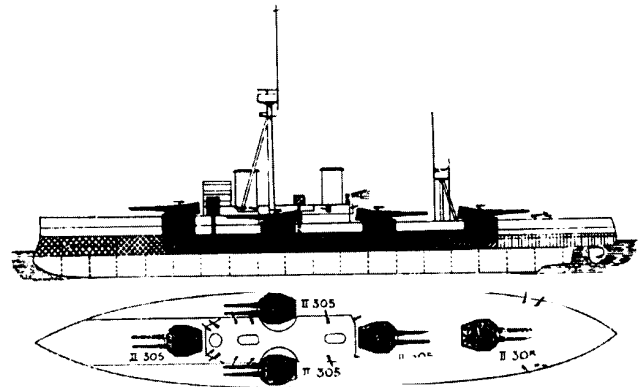

## H.M.S. Dreadnought, TL(5+1)

Dreadnoughts were the culmination of battleship design, with more armor, bigger guns, and more speed; it was estimated that any previous battleship would last no more than 5 minutes against one. This is the first of the class, launched in 1906, a real vehicle that exemplifies TL(5+1). Her complement was 773 officers and men. Because of her unusual length, officers' quarters were forward, close to the bridge, and the men's aft, reversing naval tradition. She carried one partial rotation turret forward, two amidships to left and right, and two in a line behind her superstructure. Her internal structure had total compartmentalization to keep her afloat as long as possible if damaged.

*Subassemblies:* Body +11, top Superstructure +8, five top Turrets +7, Mast +2, Mast +1.

*Power & Propulsion:* 4 × 4,900-kW steam turbine with screw propeller.

*Fuel:* 130,000 cf coal and 420,000 gal. fuel oil (10), standard, 545 hours

*Occupancy:* See above      *Cargo:* 10,000 cf

Armor	F	RL	B	T	U
<i>Body:</i>	4/420	4/660	4/280	4/70	4/70
<i>Sup:</i>	4/60	4/60	4/60	4/60	-
<i>Tur:</i>	5/780	5/780	5/780	4/170	-

### Weaponry

2 × 12-in. Naval Gun [each Tur:F] (100 HE)  
 2 × 12-lbs. Naval Gun [each Tur:F] (100 HE)  
 6 × 12-lbs. Naval Gun [Sup:R] (100 HE)  
 6 × 12-lbs. Naval Gun [Sup:L] (100 HE)  
 2 × 18" Torpedo Tube [Body:R] (5 HE)  
 2 × 18" Torpedo Tube [Body:L] (5 HE)  
 18" Torpedo Tube [Body:B] (3 HE)

### Equipment

*Sup:* Fire direction center; six ship's boats; two cranes.

### Statistics

*Size:* 39'×82'×490'      *Payload:* 12,000,000 lbs.  
*Lwt.:* 48,932,800 lbs.      *Volume:* 1,600,000 cf  
*SizeMod:* +11      *Price:* \$8,919,415.00

*HT:* 8    *HP:* 472,500 [Body] 45,900 [Sup] 30,900 [Tur1]  
 26,200 [Tur2,3] 26,700 [Tur4,5] 313 [Mast1] 165 [Mast2]

*wSpeed:* 17    *wAccel:* 0.7 (sail)/0.3 (steam)    *wDecel:* 1  
*wMR:* 0.05    *wSR:* 7

*Flotation:* 78,190,000 lbs. *Draft:* 29.3'

## Advanced Submarine, TL(5+1)

The sole power source for this undersea vessel is advanced primary batteries using a sodium-mercury amalgam: their power output is cinematic, but the other innovations are based on realistic engineering. The submarine has a luxury cabin for its captain and bunks for its crew of 20, a mini-workshop, a science laboratory dedicated to oceanography, and a four-man airlock.

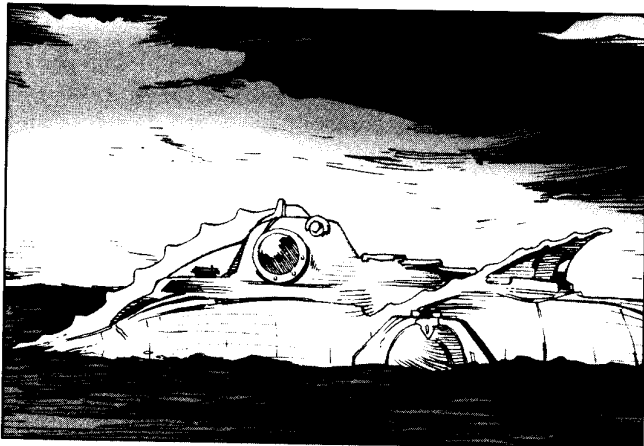

Though not conventionally armed, it has, in addition to its water cannon, a ram (+1 per die of damage in collisions) and an electrified grid in its surface (on stun setting, damage 2d, energy 4 kW; on kill setting, damage 10d, energy 20 kW). At full power its endurance is 65 hours; for routine operations speed is reduced to 11 mph, giving endurance of 649 hours.

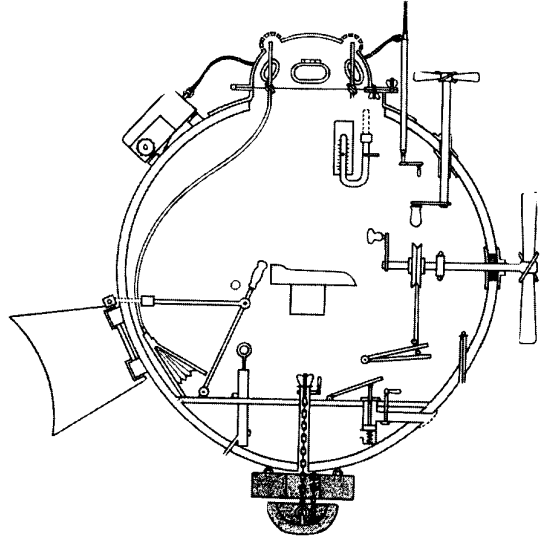

*Subassemblies:* Body +8.

*Power & Propulsion:* 1,872,000,000 kW advanced primary batteries with 8,000-kW screw propeller.

*Occupancy:* See above      *Cargo:* 1,000 cf

### Armor

*Body:* 4/133

### Weaponry

Water Cannon [Body:F] (unlimited)

### Equipment

*Body:* Searchlight (5 miles range).

### Statistics

*Size:* 17'×26'×230'    *Payload:* 24,200 lbs.    *Lwt.:* 2,991,000 lbs.  
*Volume:* 53,225 cf    *SizeMod:* +6    *Price:* \$190,000.00

*HT:* 7      *HP:* 32,655 [Body]

*wSpeed:* 20    *wAccel:* 1    *wDecel:* 1    *wMR:* 0.05    *wSR:* 4  
*uSpeed:* 25    *uAccel:* 1    *uDecel:* 1    *uMR:* 0.05    *uSR:* 4  
*Flotation:* 3,323,376 lbs. *Draft:* 17'. *Crush depth:* 2,860 yards.

## AIR VEHICLES

Victorian aircraft relied on lighter-than-air gas, rather than on airfoils. Dirigibles and airships came into use only at the end of the Age of Steam, but represent a natural extension of its technologies – as well as appealing to the imagination! Aspiring aeronauts debated which of the two principles would give humanity command of the air. The craft presented here explore both options, in unpowered and powered forms for each.

## Observation Balloon, TL5

This hot air balloon can be used to observe enemy troops and direct troop movements or artillery fire. Each flight costs \$22.50 for burner fuel and ballast. Reports are made by signal flags or notes thrown over the side. The practical altitude limit is 400', at which the horizon is 20 miles away; a 5-power spyglass is carried (+2 to detect an object at range, +4 to examine it closely).

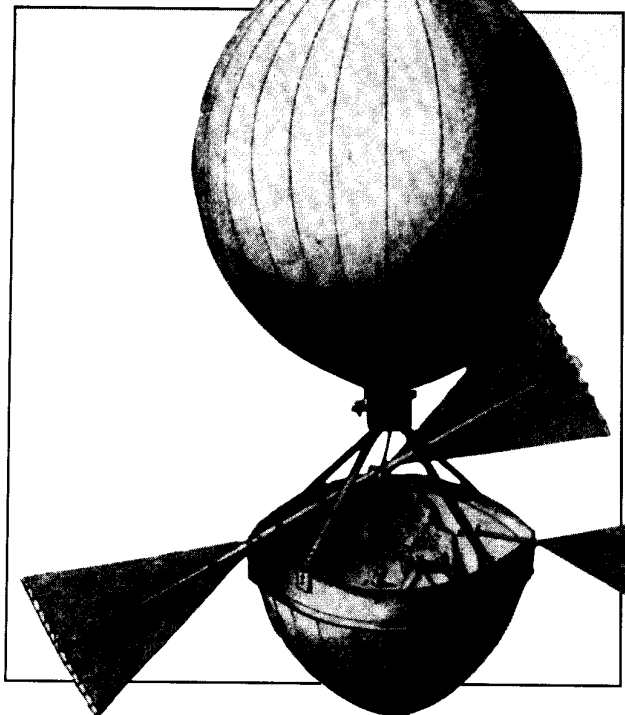

*Subassemblies:* Body +2, top Gasbag +8.

*Power & Propulsion:* hot-air lift.

*Occupancy:* 2 XNSR

### Armor

*Body:* 1/1 W

### Statistics

*Size:* 44' diameter      *Payload:* 400 lbs.      *Lwt.:* 693 lbs.

*Volume:* 45,060 cf      *SizeMod:* +8      *Price:* \$4.60

*HT:* 8      *HP:* 9 [Body]      76 [Gas]

*aSpeed:* 0      *aAccel:* 0      *aDecel:* 0.5      *aMR:* 0.125      *aSR:* 3  
Lift 750 lbs. Stall Speed 0. Climbing Speed 7.

## Cargo Dirigible, TL(5+1)

This non-rigid-body craft is designed to haul bulk cargo (50 lbs./cf) over continental ranges (up to 2,100 miles). Each flight costs \$12,432 for hydrogen and \$900 for fuel oil. The crew is divided into two watches. Each watch (consisting of 17 riggers, two chiefs, a mechanic, and a pilot) takes turns, four on and four off. The craft also carries a master, an engineer, and a cook.

*Subassemblies:* Body +6, Gasbag +12.

*Power & Propulsion:* hydrogen lift; 3 × 450-kW steam turbine with aerial propeller.

*Fuel:* 15,000 gal., fuel oil (11), light, 111 hours.

*Occupancy:* 2 RCS, 3 C, 19 C [Gas]      *Cargo:* 1,100 cf

### Armor

*Body:* 2/2

### Statistics

*Size:* 55'×50'×360'      *Payload:* 154,000 lbs.      *Lwt.:* 230,000 lbs.

*Volume:* 3,561,000 cf      *SizeMod:* +12      *Price:* \$13,150

*HT:* 7      *HP:* 2,100 [Body]      1,397 [Gas]

*aSpeed:* 19      *aAccel:* 0.3      *aDecel:* 0.5      *aMR:* 0.125      *aSR:* 4  
Lift 240,000 lbs. Stall Speed 0. Climbing Speed 32.

## Aerial Dreadnought, TL(5+1)

This colossal airship is equipped for combat with other airships at ranges of up to 9 miles by indirect fire, as well as for bombing land or seagoing targets. A fire direction center gives +3 to hit a single target with concerted fire from its six guns. Aerial dreadnoughts are equipped for a variety of emergencies, with a four-table operating room, a complete mini-workshop, and emergency power from a 54,000-kWs flywheel. Hammocks provide accommodations for a crew of 300, and 30 cabins have space for up to 60 officers and non-coms. Resupply is needed every five days, including 259,000 gallons of liquid hydrogen and 70,000 gallons of fuel oil.

*Subassemblies:* Body +13, bottom Substructure +8, two bottom Turrets [Sub] +3.

*Power & Propulsion:* 3 × 2,000-kW steam turbine with aerial propeller.

*Fuel:* 70,000-gal., fuel oil (12), ultralight, 116 hours.

*Occupancy:* See above      *Cargo:* 2,605 cf

Armor	F	RL	B	T	U
<i>Body:</i>	2/2	2/2	2/2	2/2	2/2
<i>Sub:</i>	3/10	3/10	3/10	–	3/10
<i>Tur:</i>	6/60	5/45	5/45	–	4/30

### Weaponry

3 × 40mm Cannon [Tur1] (300 Solid each) +2

3 × 40mm Cannon [Tur2] (300 Solid each) +2

800 × 110-lbs. HE bomb [Sub] +2

### Equipment

*Sub:* Fire direction center: Improved optical bombsight; Refueling probe, 190 gal./minute fuel oil; 2 × Refueling probe, 190 gal./minute liquid hydrogen.

### Statistics

*Size:* 210'×205'×1,320'      *Payload:* 655,000 lbs.

*Lwt.:* 1,987,000 lbs.      *Volume:* 29,673,000 cf

*SizeMod:* +13      *Price:* \$1,405,000

*HT:* 12      *HP:* 99,900 [Body]      4,500 [Sub]      135 [Tur]

*aSpeed:* 30      *aAccel:* 0.15      *aDecel:* 0.5      *aMR:* 0.125      *aSR:* 4  
Lift 2,000,000 lbs. Stall Speed 0. Climbing Speed 25.



## Sky City, TL(5+1)

The sky city is a vehicle only by courtesy, having no engines, though large aerial tugs linked to its external cradles can push it slowly through the air. The external surface is coated with bricks impregnated with an 80% chemical gravity screen (see p. 99) and also acting as low-tech fireproof ablative armor (that is, 1 DR is lost from a face per 10 points of damage caused by an attack). The sky city is a hemisphere with the flat face up, occupied by 44 acres of structures and landscaping, while the engines and tanks are at the base. The payload for this design is not specified. Only the personnel needed to keep the sky city aloft are counted: some 2,100 including two watches of 1,000 riggers.



The sky city can be used as a setting for a variety of adventures. It could be the site of a research project or an international conference. For more excitement, have unexpected bad weather damage its gravity screen, threatening a fall – perhaps into the heart of London or New York. Or, in a decadent future, have explorers enter a sky city in whose dark interior lurk descendants of the original crew.

**Subassemblies:** Body +16.

**Power & Propulsion:** gravity screen lift; 25,000-kW steam turbine.

**Fuel:** 1,800,000-gal., fuel oil (10), 180 hours.

**Occupancy:** See above

### Armor

**Body:** 3/5 A

### Statistics

**Size:** 1,240' diameter      **Payload:** 125,314,320 lbs.  
**Lwt.:** 289,855,070 lbs.      **Volume:** 1,000,000,000 cf  
**SizeMod:** +16      **Price:** \$4,113,000

**HT:** 12      **HP:** 4,318,106 [Body]

**aSpeed:** 0    **aAccel:** 0    **aDecel:** 0.5    **aMR:** 0.125    **aSR:** 4  
Lift 289,855,070 lbs. Stall Speed 0. Climbing Speed 2.

## Prototype Glider, TL5

A number of Victorian inventors experimented with gliders; if one of these experiments had worked better, it might have resembled this wood-and-fabric craft. Biplane wings generate lift, but the glider can't take off unaided; it must be towed or launched. A 120' track resembling a roller coaster, built atop a cliff, could get it into flight, at a cost of \$200 for the track. To maintain air speed, the glider must descend 4.5' per minute per mph of air speed, or a minimum of 76.5' per minute. To reduce drag, this version has no wheels; it lands on its belly.

**Subassemblies:** Body +0, two Wings -2.

**Occupancy:** 1 XCCS

### Armor

**Body:** 1/1 N

**Wing:** 1/1 N

### Statistics

**Size:** 1.5'×14'×7'      **Payload:** 200 lbs.      **Lwt.:** 323 lbs.  
**Volume:** 12 cf      **SizeMod:** +1      **Price:** \$14.25

**HT:** 12      **HP:** 11 [Body]      7 [Wing]

**aSpeed:** 0    **aAccel:** 0    **aDecel:** 26    **aMR:** 6.5    **aSR:** 1  
Stall Speed 17.

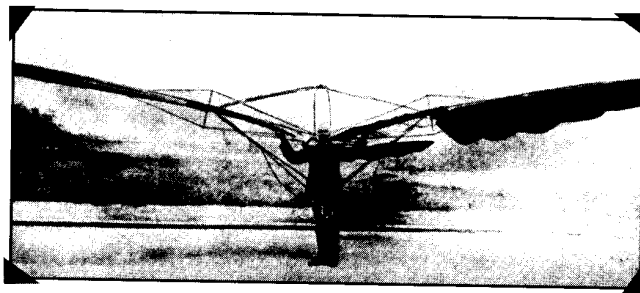

## Ornithopter, TL(5+1)

This exotic craft realizes old dreams of an aircraft that flew with flapping wings, like a bird. To maximize lift it is designed as a triplane, with a framework of hollow metal tubing over which tough fabric is stretched. On the ground it runs on three small wheels; these are not armored but have wheelguards (no protection from below; 4-in-6 chance of protecting against attacks from other directions). Given the difficulties of controlling such a complex system, the ornithopter should be treated as a cinematic vehicle.

**Subassemblies:** Body +3, three Wheels +0, two Wings +1.

**Power & Propulsion:** 50-kW sextuple-expansion steam engine with ornithopter drivetrain.

**Fuel:** 1 cf coal, 1.33 hours.

**Occupancy:** 1 CCS, 1 CS      **Cargo:** 4 cf

### Armor

**Body:** 2/2 N

**Whl:** 2/2 N

**Wing:** 2/2 N

### Statistics

Size: 4'x28'x25'    Payload: 530 lbs.    Lwt.: 4,320 lbs.  
 Volume: 180 cf    SizeMod: +3    Price: \$1,905

HT: 8    HP: 64 [Body]    5 [Whl]    56 [Wing]

gSpeed: 40    gAccel: 3    gDecel: 10    gMR: 0.75    gSR: 2  
 aSpeed: 55    aAccel: 0.5    aDecel: 16    aMR: 4    aSR: 2  
 Stall Speed 25. Takeoff Run 52 yards. Landing Run 16 yards.

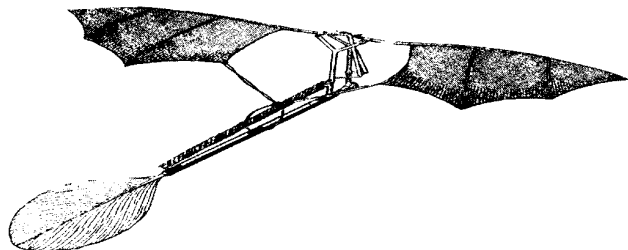

### Electric Aeronef, TL(5+1)

Propelled by reactionless thrust (see Chapter 6, p. 96), this craft is kept aloft by lift generated by airfoils. Its power comes from primary batteries – big jars of acid with electrodes – making up over half its loaded weight; they provide power for a half-hour flight. The body is expensive wood covered with fabric, for the best strength-to-weight ratio. It looks like a pre-World War I airplane, except that it has no propeller.

*Subassemblies:* Body +2, three Wheels -1, two Wings -1.  
*Power & Propulsion:* 50,000-kWs primary batteries with 27.5-kW standard thruster.  
*Occupancy:* 1 CCS

### Armor

Body: 1/1 N

Wing: 1/1 N

### Statistics

Size: 4'x15'x8'    Payload: 200 lbs.    Lwt.: 924 lbs.  
 Volume: 32 cf    SizeMod: +2    Price: \$310

HT: 9    HP: 23 [Body]    2 [Whl]    8 [Wing]

gSpeed: 60    gAccel: 4    gDecel: 10    gMR: 1    gSR: 2  
 aSpeed: 85    aAccel: 1    aDecel: 8    aMR: 2    aSR: 1  
 Stall Speed 45. Takeoff Run 127 yards. Landing Run 51 yards.

## SPACE AND TIME VEHICLES

The heroes of Victorian novels went into space or visited other planets by an amazing variety of methods, from being shot out of huge guns to astral projection – but not by rockets. In fact, the low exhaust velocities of TL5 solid-fuel rockets could not have gotten into space, though Konstantin Tsiolkovsky speculated about improved rockets in the 1890s. Steampunk spacecraft depend on weird science or cinematic disregard for engineering problems. The following craft illustrate both approaches – along with another Victorian weird science idea, travel in time.

### Lunar Shell, TL5

This space vehicle, made out of advanced light metals, provides cramped quarters for three men, with chemical air renewal for 50 man-days (see p. 93). It has no true space drive – it can be gotten into space by a huge multistage solid-fuel rocket, by being shot out of a large cannon (with a cinematic disregard for what 11,000 G will do to the passengers), or by an advanced magnetic catapult. Small solid-fuel rockets allow some maneuvering.

*Subassemblies:* Body +4.

*Power & Propulsion:* 12 x solid fuel rocket, 1412 lb thrust, 1 minute.

*Occupancy:* 3 CCS

*Cargo:* 100 cf

Armor	F	RL	B	T	U
Body:	4/72	4/72	4/72	4/72	4/216

### Statistics

Size: 12'x9' diameter    Payload: 4,600 lbs.    Lwt.: 30,279 lbs.  
 Volume: 859 cf    SizeMod: +4    Price: \$19,600

HT: 12    HP: 2,418 [Body]

aSpeed: 0    aAccel: 0    aDecel: 0.5    aMR: 0.125    aSR: 1  
 sAccel: 1 (0.05G)

### Electric Astronef, TL(5+1)

Embodying several advances on the design of the electric aeronef, this craft can actually fly into orbit. A sealed body and a limited life system (able to support up to four men for a total of 2 man-days) make such missions viable. Its design is radical for its era, with good streamlining and retractable wheels to reduce drag, while extraordinarily large, high-mounted wings give it enough lift to take off despite the huge weight of its batteries. In addition to outright space travel, it is capable of flight in the upper atmosphere; the low pressure raises its stall speed to 120, but also reduces drag, raising its top speed to 865.

*Subassemblies:* Body +5, two Wings +3, three Wheels +2.

*Power & Propulsion:* 57,600,000 kWs advanced primary batteries with 2,000-kW super thruster.

*Occupancy:* 2 RCS

*Cargo:* 110 cf

### Armor

Body: 2/2

Wing: 2/2

### Statistics

Size: 9'x57'x232'    Payload: 2,600 lbs.    Lwt.: 67,835 lbs.  
 Volume: 1,770 cf    SizeMod: +5    Price: \$55,650

HT: 7    HP: 517 [Body]    46 [Whl]    347 [Wing]

gSpeed: 95    gAccel: 5    gDecel: 10    gMR: 0.25    gSR: 3  
 aSpeed: 235    aAccel: 1    aDecel: 10    aMR: 2.5    aSR: 3  
 sAccel: 1 (0.06G)

Stall Speed: 95. Takeoff Run: 451 yards. Landing Run: 226 yards.

## Solar Steamer, TL(5+1)

Based on reactionless thrusters created by advanced etheric science, the solar steamer opens up the inner solar system to human exploration. Under steady acceleration, its travel time is 25 days  $\times$  (square root of distance in AU), where 1 AU = 93,000,000 miles. It is a deep-space craft, with no landing gear or aerodynamic features. Craft such as the electric astronef are used to reach planetary surfaces. An onboard greenhouse provides life support for 36 (28 crew and up to 8 passengers) and produces half of their food; meat and dairy products must be carried in storage areas. Lead-acid batteries provide 360,000 kW of backup power. An operating table and a complete mini-workshop are available for emergencies. The ship has heavy compartmentalization. A three-man airlock provides access to the outside.

*Subassemblies:* Body +8, six Masts +4.

*Power & Propulsion:* 3,600 solar steam engine, sextuple-expansion, with 3,500-kW super thruster.

*Occupancy:* See above      *Cargo:* 7,500 cf

### Armor

*Body:* 3/5

### Statistics

*Size:* 16'  $\times$  16'  $\times$  160'      *Payload:* 157,200 lbs.      *Lwt.:* 639,000 lbs.  
*Volume:* 36,800 cf      *SizeMod:* +8      *Price:* \$32,000

*HT:* 6      *HP:* 2,250 [Body]      1,040 [Mast]

*sAccel:* 0.25 (0.0125 G)

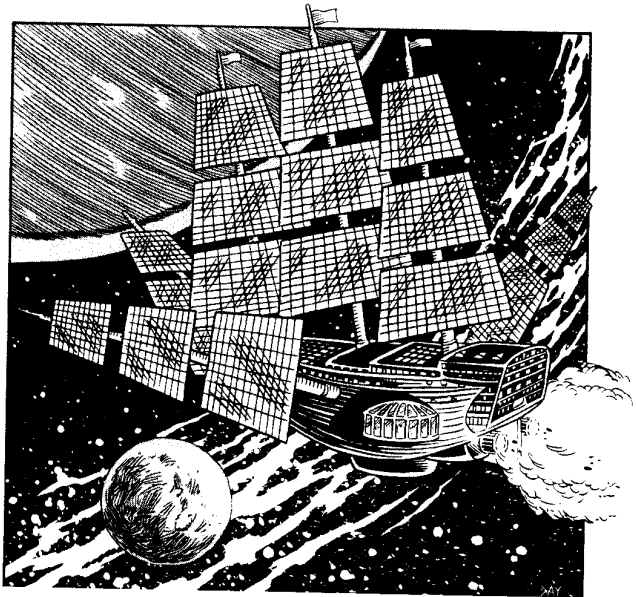
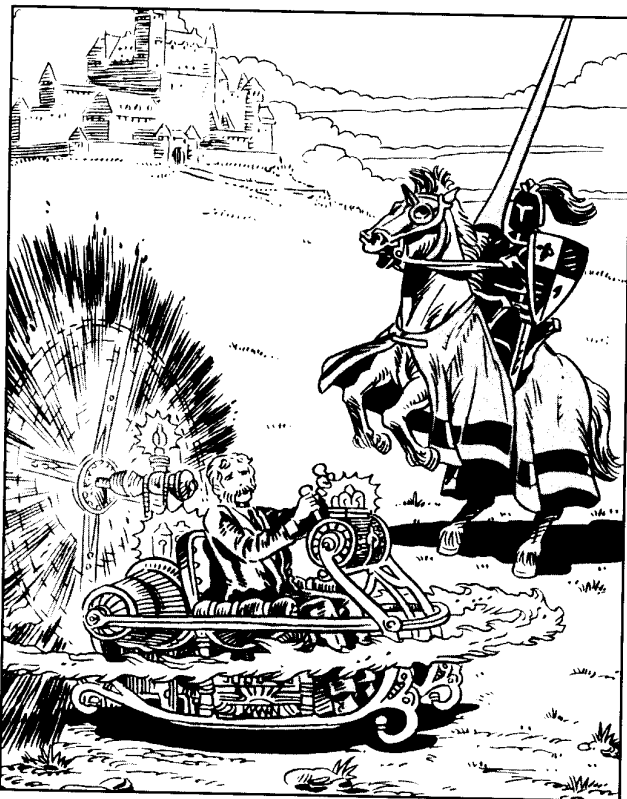

## Time Machine, TL(5+n)

This unusual craft applies unknown principles to travel in time rather than space. A time engine weighs a minimum of 32 lbs. and consumes a minimum of 1 kW per ton propelled in time – this is sufficient to move it toward the future, or toward the past, at a rate of 10 hours of external time per 1 hour experienced by the traveler. Each further tenfold increase adds the same weight and power requirement; thus, an engine capable of 1,000 hours/hour weighs 96 pounds and consumes 3 kW per ton propelled. Volume is 1 cf per 50 lbs.; cost is \$4.50 per lbs.

The time machine can accelerate from the present into the past or future by a factor of 10 per 10 seconds. If the machine accelerates at a faster rate, passengers will require a Fright Check to cope with physical and mental strain. Apply a -1 modifier for each factor of 10 over the normal acceleration rate. A time machine traveling at up to 10 hours/hour can be seen or sensed as a faint presence on a critical Vision roll – above that rate it is imperceptible.

This model can be dragged, with difficulty, on a level surface (see p. B89). It can be rewound in 600,000/ST seconds, to provide power for 2,000 seconds of travel. Its armor is an open frame (2-in-6 chance of protecting against thrusting attacks or small missiles).

*Subassemblies:* Body +1, two Skids -1.

*Power & Propulsion:* 12,000-kWs advanced clockwork with 6-kW time engine.

*Occupancy:* 1 XRCS

### Armor

*Body:* 1/1

*Skid:* 1/1

### Statistics

*Size:* 3'  $\times$  4'  $\times$  7'      *Payload:* 200 lbs.      *Lwt.:* 1,000 lbs.  
*Volume:* 31 cf      *SizeMod:* +2      *Price:* \$1,490

*HT:* 12      *HP:* 42 [Body]      3 [Skid]

*tSpeed:* 114,000,000 years/hour

# ANALYTICAL ENGINES AND AUTOMATA

Machines for computation go back long before the 19th century; the Antikythera device, a hand-cranked bronze analog computer for astronomical and calendrical problems, was found in a wrecked ship from the first century B.C.! Through early TL5, such devices were made from specially designed parts laboriously fitted together. Precision machining and steam power were the first technological developments that made them easier to construct. Babbage's Analytical Engine, which would have been the first general-purpose computer, depended on both. These rules can be used to create both analytical engines and specialized automata at any TL back to 1; TL0 societies do not build such complex mechanisms.

The measure of the sophistication of any analytical engine is its Complexity, ranging from -2 to 6. Complexities of 0 or less actually describe clocks, artificial singing birds, and other automata. A device has IQ equal to Complexity +3,

so the lowest possible IQ is 1. Guidelines for the tasks such devices can perform are as follows:

- Complexity -2: Perform a simple arithmetical operation (addition); carry out a fixed sequence of actions (clock, music box)
- Complexity -1: Perform four-function arithmetic; carry out a fixed sequence of coordinated actions (orrery, Jacquard loom); maintain a steady state (thermostat, steam engine governor)
- Complexity 0: Maintain motion in a fixed direction (autopilot)
- Complexity 1: Carry out a program in machine code
- Complexity 2: Interpret a language
- Complexity 4: Limited personality simulation, interpret a natural human language
- Complexity 5: Full personality simulation
- Complexity 6: Capable of sentience

## Analytical Engines and Automata

Type	Wt. (lbs.)	Vol. (cf)	Cost	Power (kW)	Complexity
Megaframe	125,000	2500	\$1,250,000	1,000	4
Macroframe	20,000	400	\$200,000	100	3
Mainframe	2,500	50	\$20,000	10	2
Microframe	1,000	20	\$4,000	1	1
Miniengine	200	4	\$1,500	0.1	0
Small device	10	0.2	\$250	-	-1
Tiny device	2.5	0.05	\$50	-	-2
<i>TL Modifiers</i>					
Built at TL1-4	×1	×1	×10	×1	-1* **
Built at TL5	×1	×1	×1	×1	0*
Built at TL(5+1)	×1/2	×1/2	×1/2	×1	+1
<i>Options</i>					
Automaton	×1	×1	×1	×1	-
Compact	×1/2	×1/2	×2	×1	-
Dedicated	×1/2	×1/2	×1/5	×1	-
Dumb	×1	×1	×1/5***	×1	-1
Genius	×1	×1	×7***	×1	+1
High-Capacity	×1	×1	×1.5	×1	-
Mechanical	×3	×3	×1/2	×2	-
Sentient	×1	×1	×10	×1	-
Supercompact	×1/5	×1/5	×10	×1/2	-

\*Historically, engines built at TL1-6 are always Dedicated. Any system that is not Dedicated has an extra -2 to Complexity. This does not apply to engines built at TL(5+1), including Babbage's Analytical Engine.

\*\*Systems built at TL1-4 may not have complexity higher than TL-3 (i.e., maximum IQ equals TL).

\*\*\*For small and tiny devices, "genius" multiplies cost by 20, and "dumb" multiplies cost by 1/20. For mainframe, macroframe, and megaframe engines, "genius" multiplies cost by 20; "dumb" multiplies cost by 1/5.

Here is what the options mean:

*Automaton:* The engine is designed to operate a humanoid or vehicular body that can move about the environment. DX equals (Complexity/2) + 8, rounded down.

*Compact and Supercompact:* The engine is built with small parts and is more expensive as a result.

*Dedicated:* The engine can only run a single program, which is built into its mechanisms.

*Dumb and Genius:* The engine has lower or higher Complexity than normal for its TL and size.

**High-Capacity:** The engine can run up to three, rather than the usual two, programs of its own Complexity.

**Mechanical:** The engine is built with purely mechanical parts; no relays or other electrical switches are involved. It cannot be disrupted by electrical effects (the equivalent of Hardened). Historically, any system at TL5 or less should have this option.

**Sentient:** The engine has self-awareness comparable to that of a human being. Only an engine at Complexity 6 can be given sentience. A sentient engine has IQ equal to Complexity + 5.

In a cinematic campaign, any engine with Complexity greater than 0 may spontaneously attain sentience. This happens too seldom to roll for; it can be the premise for a storyline or for the existence of a player character who is an automaton. An engine that attains sentience spontaneously reorganizes its functions to gain +1 to Complexity, in addition to the usual benefits of sentience.

## EXAMPLES OF ANALYTICAL ENGINES AND AUTOMATA

### *Athena, TL(5+1)*

This is the steampunk analog of a supercomputer: a megaframe with the Genius, High-capacity, and Mechanical options. It weighs 187,500 lbs., occupies 3,750 cf., costs \$9,375,000, consumes 2,000 kW, and has Complexity 6 (IQ 9). The standard power source is a sextuple-expansion steam engine weighing 88,220 lbs. and burning 30 cf/hour of coal.

### *Difference Engine, TL5*

This is Babbage's first design, a highly sophisticated calculator intended to generate and print mathematical tables. Information is input on punched cards copied from the Jacquard automatic loom; results are used to control an automatic typesetting engine. This is a mainframe with the Compact, Dedicated, and Mechanical options. It weighs

1,875 lbs., occupies 37.5 cf, costs \$4,000, consumes 20 kW, and has Complexity 2 (IQ 5).

### *Golden Nightingale, TL3*

This is an artificial songbird formed from precious metals for some imperial court. It is a tiny device with the Automaton, Dedicated, Genius, High-Capacity, Mechanical, and Supercompact options. It weighs 0.75 lbs., occupies 0.015 cf, costs \$15,000, consumes negligible power, and has Complexity -2 (IQ 1, DX 7). It plays any of three different songs.

In a silly campaign, clockwork pets might not be so exclusive. They might even be a fad, attracting legions of middle-class consumers, and coming in a variety of different animal forms.

### *Mechanical Brain, TL(5+1)*

This is an analytical engine suitable for controlling a human-scale mechanical man. It is a microframe with the Automaton, Genius, and Supercompact options. It weighs 100 lbs., occupies 2 cf, costs \$140,000, consumes 0.5 kW, and has Complexity 3 (IQ 6, DX 9), sufficient to understand simple spoken orders and give prerecorded responses. It can be programmed with basic skills, usually physical.

### *Player Piano, TL5*

The Victorian age's version of the CD player, this is a small device with the Automaton, Dedicated, and Mechanical options. It weighs 15 lbs. (not counting the piano!), occupies 0.3 cf, costs \$25, consumes negligible power, and has Complexity -1 (IQ 2, DX 7).

### *Steam Calliope, TL5*

The control system for a steam calliope is a miniengine with the Automaton, Dedicated, Dumb, and Mechanical options. It weighs 300 lbs., occupies 6 cf, costs \$30, consumes 0.2 kW, and has Complexity -1 (IQ 2, DX 7). It can run a calliope of any size and weight.

## MECHANICAL MEN

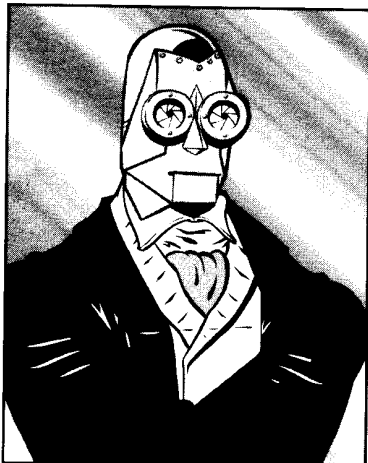

Mechanical men, or automata (the words "robot" and "android" are coined decades in the future), can be designed using *GURPS Robots*, with an analytical engine (pp. 85-86) rather than a computer. Multiply costs of any components described in *GURPS Steampunk* by 20 before including them in the design process, and divide the

final cost by 20. Sensor and communicator packages have doubled weight, volume, and cost from those in *GURPS Robots*; limb analogs are treated similarly, as they are for vehicles.

Mechanical men are rare or unique in most steampunk worlds. It may be more convenient to design the statistics directly, treating the model as a race, as follows. A basically humanoid body design is assumed.

A mechanical man's design DX and IQ are based on its Complexity. An analytical engine of a given Complexity needs a certain minimum size, which requires a minimum total weight, ST, and HT for its body. Models can be designed with higher ST and HT. Move (ground speed) is 5. Use the following table:

## Attributes of Mechanical Men

Complexity	DX	IQ	Height	Weight	ST	HT	Body HP
<i>Built with Mechanical Brains</i>							
1	8	4	3 ft.	29 lbs.	1	12	1
2	9	5	5 ft.	175 lbs.	3	8	3
3	9	6	9 ft.	843 lbs.	22	8	11
4	10	7	15 ft.	2,880 lbs.	85	7	28
5	10	8	27 ft.	18,000 lbs.	470	6	113
6	11	9	54 ft.	135,000 lbs.	2,600	6	450
<i>Built with Electromechanical Brains</i>							
1	8	4	2 ft.	28 lbs.	1	12	1
2	9	5	4 ft.	72 lbs.	1	11	2
3	9	6	7 ft.	340 lbs.	7	9	6
4	10	7	11 ft.	1340 lbs.	30	8	19
5	10	8	21 ft.	8700 lbs.	210	7	66
6	11	9	42 ft.	62,500 lbs.	1,500	6	300

If a mechanical man with Complexity 6 is designed to be sentient, increase its design IQ to 11. If a mechanical man in a cinematic campaign spontaneously awakens, give it +1 Complexity for its size (with the corresponding DX and IQ) and then increase its IQ by 2 more points.

Now choose advantages and disadvantages. Certain of these are standard, with point costs as follows: the advantages of Absolute Timing [5], Doesn't Sleep [20], Eidetic Memory 2 [60], High Pain Threshold [10], Immunity to Disease [10], Lightning Calculator [5], and Mathematical Ability [10], and the disadvantages of No Natural Healing [-20], No Sense of Humor [-10], Reprogrammable Duty [-25], Rote Learning [-15], and Slave Mentality [-40]. The net cost is 10 points. For a sentient mechanical man, remove Reprogrammable Duty, Rote Learning, and Slave Mentality; it thus costs 90 points to be a sentient mechanical man. Add other appropriate advantages and disadvantages.

For a nonsentient or spontaneously awakened mechanical man, add skills built into the original design. Normally, these should be bought to a skill of 12. These are all the skills a nonsentient mechanical man will ever know; a spontaneously awakened one can learn more skills in the usual way, and a mechanical man constructed to be sentient learns all its skills in this way.

Most mechanical men have the disadvantages of Bad Grip [-10], uncorrectable Bad Sight [-25], Disturbing Voice [-10], Hard of Hearing [-10], and No Sense of Smell/Taste [-5], adding up to -60. Many mechanical men have Inconvenient Size [-10 if over 8']. An analytical engine can be treated as a character, in effect a mechanical man without the ability to move. If it has arms, treat it as Sessile [-50], if not give it No Manipulators [-50] also.

This assumes a coal-fueled power plant with fuel for 12 hours. A mechanical man can function 6 minutes with springs [-50], 1 hour with cinematic advanced springs [-25], or 3 hours with lead-acid batteries [-10]. A mechanical man with no internal power source can be powered by an electrical cord or a steam or pneumatic hose [-100].

Add up all the point values so far listed. Divide by 1 if the mechanical man's appearance perfectly simulates humanity, by 2 if it has a sculptured form comparable to that of a mannequin, or by 5 otherwise. The result is the model point cost.

For a nonsentient mechanical man, add disadvantages to reflect wear and tear since construction. For a sentient mechanical man, treat the model cost as a net advantage or disadvantage in character design. Now build the mechanical man as a character, buying DX and IQ up (or down) from the design values and buying mental advantages and disadvantages, quirks, and skills and maneuvers.

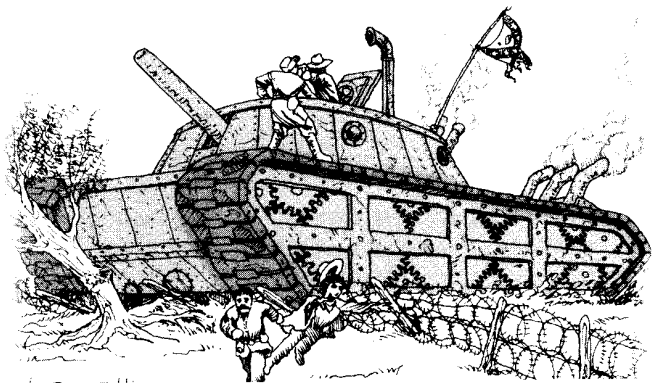

## WEAPONS

The tables that follow list a variety of weapons, from realistic 19th-century weapons to advanced steampunk innovations, emphasizing the innovations. For a wider selection of realistic 19th-century weapons, see pp. HT123-127. Most of

these weapons are ranged. Sizes range from pocket derringers up to main guns for battleships. Some of these weapons are based on weird science concepts more fully described in Chapter 6.

## MARVELOUS INVENTIONS

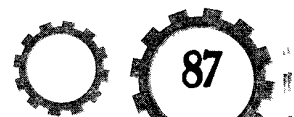



## Hand Weapons

Skill	Weapon	Type	Damage	Reach	Cost	Wt.	Min. St	Notes	TL
Broadsword	Cane	Cr.	sw+1	1	\$2	3 lbs.	9		4
Broadsword	Cavalry Saber	Cut.	sw+1	1	\$2.50	3 lbs.	9		4
Fencing	Sword Cane	Imp.	thr+1	1	\$10	1.5 lbs.	-	Weight is for drawn blade; treat as cane when sheathed	5
Knife	Bowie Knife	Cut.	sw-2	C, 1	\$0.50	1 lbs.	-	Can be thrown	5
Shortsword	Truncheon	Imp.	thr	C	\$1	1 lbs.	7		5
Staff	Daibo	Cr.	sw	1	\$1.50	12 lbs.	18	Designed as a hand weapon for an o-daisuchiimu	5
		Cr.	sw+6	1, 2					

## Ranged Weapons

Weapon	Malf	Type	Damage	SS	Acc	1/2D	Max	Wt.	RoF	Cost	Shots	ST	Rcl.	WPS	CPS	TL
Wogdon Duelling Pistol (.45)	15	Cr.	2d-1	10	3	75	450	2.75 lbs.	1/15	\$100	1	11	-1	.016	\$0.02	5
Colt Navy Revolver (.36)	16	Cr.	2d-1	9	2	120	1,300	2.5 lbs.	1	\$15	6	10	-1	.04	\$0.02	5
Remington Double Derringer (.41)	Crit.	Cr.	1d	11	1	80	650	0.5 lbs.	1	\$10	2	9	-1	.06	\$0.02	5
Colt Peacemaker (.45)	Crit.	Cr.	2d+1	11	2	150	1,700	2.5 lbs.	1	\$15	5	11	-2	.06	\$0.02	5
Martini-Henry Rifle (.45)	Crit.	Cr.	5d	15	7	600	2,000	6 lbs.	1/4	\$20	1	10	-2	.1	\$0.02	5
Dinosaur Rifle (.43)	Crit.	Cr.	10d	17	11	840	4,300	24 lbs.	1	\$75	6	14	-2	.167	\$0.02	(5+)
Personal Artillery (.79)	Crit.	Cr.	12d	20	10	500	3,200	32 lbs.	1/2	\$100	6	19	-3	.45	\$0.04	(5+)

Note: The Wogdon duelling pistol and the Colt Navy revolver are black powder weapons.

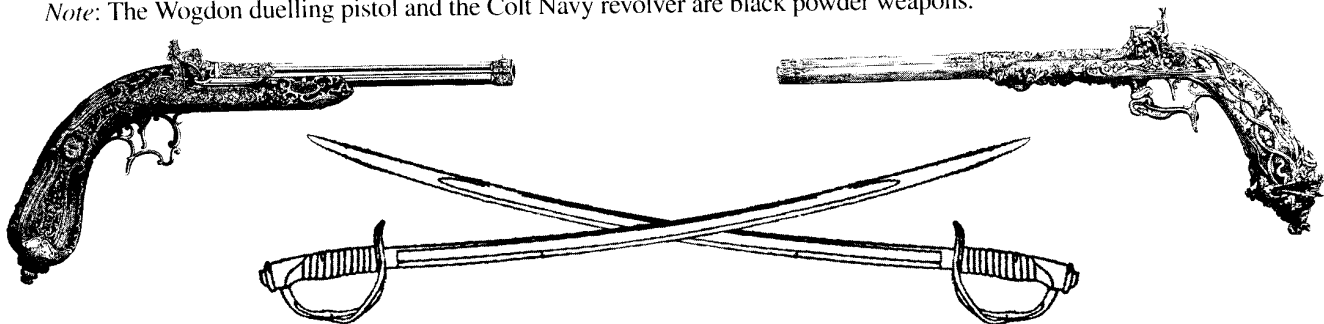

## Artillery

Weapon	Malf	Type	Damage	SS	Acc	1/2D	Max	Wt.	RoF	Cost	WPS	CPS	Ldrs.	TL
Heavy Rifle (.47)	16	Cr.	7d-1	17	12	490	3,100	20 lbs.	1	\$75	0.216 lbs.	\$0.022	0	5
Gatling Gun (.58)	16	Cr.	5d	20	12	700	2,100	390 lbs.	(DX + Gunner)/2	\$200	.11 lbs.	\$0.02	0	5
Naval Gun, 12-in.	16	Cr.	6d x20	30	15	1,600	6,400	17,000 lbs.	1.51	\$2,150	1,600 lbs.	\$16	7	5
Gatling Electrical (.58)	16	Cr.	6d x110 [12d]	25	12	1,100	2,900	770 lbs.	50	\$1,200	.07 lbs.	\$0.02	0	(5+)
Helmet Gun	16	Cr.	6d-1	14	8	230	2,000	14 lbs.	1	\$52.50	.44 lbs.	\$0.90	0	(5+)
Cannon (1.375)	16	Cr.	6d ∠ 4	20	14	1,000	4,000	200 lbs.	1/2	\$500	2.4 lbs.	\$0.25	0	(5+)
Naval Gun, 12-lbs.	Crit.	Cr.	2d [4d]	25	13	960	4,700	1,200 lbs.	1/4	\$350	24 lbs.	\$0.25	1	(5+)
Naval Gun, 12-in.	Crit.	Cr.	6d x8	30	15	1,900	7,100	20,000 lbs.	1/15	\$5,000	1,600 lbs.	\$40	4	(5+)
Water Cannon	Crit.	Cr.	Exp. 20d [6d]	5	8	60	90	240 lbs.	8	\$60	4.25 lbs.	-	-	(5+)
Magnetoballista, 5-mm	16	Cr.	Exp. 6d x220 [12d]	20	16	2,400	8,300	150 lbs.	3~	\$8,200	0.0047 lbs.	\$0.002	0	(5+)
Magnetoballista, 10-mm	16	Cr.	4d	25	18	5,100	14,000	600 lbs.	3~	\$32,000	0.0375 lbs.	\$0.015	0	(5+)

Note: The helmet gun is a recoilless weapon built into the battlesuit (see p. 76); its backblast range is 2 yards. The magnetoballista uses electromagnets to propel a steel shell at

extremely high speeds. Power required for operation of the magnetoballista is 85 kW (5-mm) or 675 kW (10-mm).

## Bombs, Rockets, and Torpedoes

Weapon	Malf	Type	Damage	Spd	End	Max	Min	WPS	VPS	CPS	TL
Chinese Rocket	14	Exp.	3d	200	.75	150	-	6.6 lbs.	0.13 cf	\$2.50	4
Congreve Rocket	16	Exp.	6d × 4 [10d]	360	1.4	500	-	32 lbs.	0.64 cf	\$16	5
High Explosive Bomb	Crit.	Exp.	6d × 160 [12d]	-	-	-	-	110 lbs.	2.2 cf	\$110	(5+1)
Incendiary Bomb	Crit.	Spcl.	40 yd	-	-	-	-	6.2 lbs.	0.12 cf	\$7.50	(5+1)
Torpedo, 18"	16	Exp.	6d × 2,000 [12d]	60	84	5000	200	2,280 lbs.	15 cf	\$760	(5+1)

## Launchers

Launcher	SS	RoF	Wt.	Cost	Ldrs.	Rating	TL
Dragon Mouth, 2"	12	1/30	10 lbs.	\$37.50	0	6.6 lbs.	4
Torpedo Tube, 18"	30	1/15	4600 lbs.	\$5,950	1	2,280 lbs.	(5+1)

*Note:* The dragon mouth, a launcher for the Chinese rocket, is man-portable. As such, it has Acc 7, weighs 16.6 lbs. when

loaded, and requires ST 9. The Congreve rocket does not require a launcher; it is mounted on a stick that is thrust into the ground.

## Portable Energy Weapons

Weapon	Malf	Type	Damage	SS	Acc	1/2D	Max	RoF	Wt.	Cost	Shots	ST	TL
Hand Flasher	16	Spcl.	-1 HT	9	6	130	260	1/2	7.9 lbs.	\$260	4	8	(5+1)
Etheric Shock Rifle	16	Imp.	6d × 9	12	12	150	190	0.5	11.3 lbs.	\$125	10	-	(5+1)

*Notes:* The hand flasher uses a high-voltage electrical discharge through gas to produce an intense flash of light. Any character targeted by it must roll vs. HT if hit, at the indicated penalty. The effect of any failure is stunning and -1 to Vision rolls per point of failure (complete blindness on failure by 10 or any critical failure). A successful roll vs. HT (one attempt per turn) leads to recovery from stun. After 20-HT minutes (minimum 1 minute) a successful roll vs. HT

recovers normal vision unless the victim was completely blinded; in that case only a critical success gives full recovery. any other success leaving the victim at -1 to Vision rolls for another 20-HT minutes. After a failed HT roll impaired vision persists for 20-HT days, as Bad Sight or Blindness; after a critical failure it is permanent.

For the etheric shock rifle see Chapter 6 (p. 98).

## Heavy Energy Weapons

Weapon	Malf	Type	Damage	SS	Acc	1/2D	Max	RoF	Wt.	Cost	Power	TL
Flasher	16	Spcl.	-10 HT	25	21	5,000	15,000	1	1,300 lbs.	\$7,500	32,000	(5+1)
Etheric field cannon	16	Imp.	6d × 27	20	15	640	800	0.5	300 lbs.	\$2,500	10,800	(5+1)
Etheric shore battery cannon	17	Imp.	6d × 270	30	23	13,000	16,000	0.5	37,000 lbs.	\$185,000	1,080,000	(5+1)
Lightning cannon	12	Cr.	6d × 20	20	19	1,150	3,450	1	700 lbs.	\$5,550	45,000	(5+1)
Vibra-cannon	12	Cr.	6d × 5	10	20	220	660	1	460 lbs.	\$4,300	28,125	(5+1)
Wind cannon	12	Cr.	6d × 25	10	20	110	330	1	460 lbs.	\$4,300	28,125	(5+1)

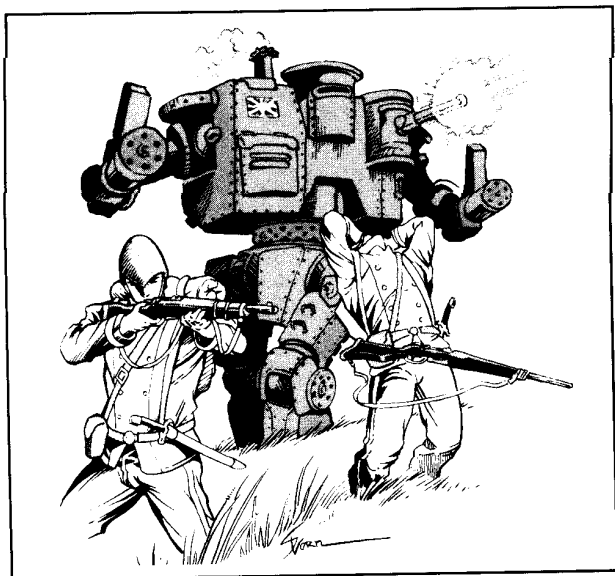

*Notes:* The flasher works like the hand flasher, but it has a second option: diffuse fire, covering a radius of 10 yards but giving only -1 HT.

The lightning cannon, vibra-cannon, and wind cannon are all "baroque weapons" (see p. ME99) suited to cinematic campaigns. Against the lightning cannon, metal armor provides PD 0, DR 1; any electrical machine whose DR is penetrated needs a roll against HT to avoid its electrical systems shorting out for one minute per point of failure. Against the vibra-cannon, PD and DR are ineffective, but damage is -1 per full 1,000 lbs. of target weight. A wind cannon automatically hits everyone in a cone extending sideways one hex per one hex of range (a retreating dodge to get out of range can avoid this). Compute knockback as from a hand-to-hand crushing blow, but actual damage is only 1 point per yard knocked back.

# PERSONAL EQUIPMENT

Several categories of equipment are available in the Age of Steam. Equipment described as TL(5+1) was historically not available in the period; for other equipment, if no year of availability is given, assume it was already available in 1815.

## OPTICS

*Binoculars:* Available after 1830. Adjustable up to  $\times 7$  magnification, they give +3 on scanning but +6 on close examination, helped by the stereoscopic effect. Weight 5.5 lbs.; cost \$2.75

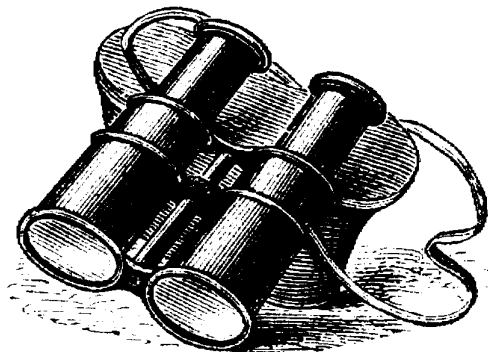

*Box Camera:* Available after 1890, the box camera holds a roll of film good for 100 photographs. When they have all been taken, the camera is shipped to the factory, where the film is developed and the camera is reloaded. The Kodak Company marketed it for use by detectives, emphasizing its small size and ease of use. Weight 2.2 lbs.; cost \$5 to buy; \$1 to process film and reload.

*Heliograph:* Available after 1879, this device uses mirrors to reflect sunlight to a distant observer as a coded signal. Weight 50 lbs.; cost \$10.

*Magnifying Lens:* A single good-quality refractor giving +2 Vision for close examination of an object or location. Under clear sunlight it can also be used to start fires with a Survival roll to find and use kindling. Weight negligible; cost \$1.50.

*Spyglass:* A small telescope designed for use in the field or on shipboard, with  $\times 3$  magnification (+2/+3 Vision). Weight 1.2 lbs.; cost \$0.50.

## TOOLS

*Lockpicks:* The necessary tools for the Lockpicking skill. Weight negligible; cost \$3.75.

*Multiplex Knife:* Manufactured for the Swiss army since 1884, multiplex knives provide a variety of small tools, including awl, file, saw, screwdriver, and wire-stripper. A mechanic with a multiplex knife and no other tools is at -3 to skill, rather than -5. Weight negligible; cost \$5.

*Oxyacetylene Torch:* A TL(5+1) device, though experimental models were developed in the 1890s. Cuts hardened steel at 1"/minute. Weight 50 lbs.; cost \$50.

## OTHER DEVICES

*Clockwork Arm/Leg:* These TL(5+1) prosthetics combine advanced drivetrains with compact analytical engines that anticipate the wearer's movements and execute a limited range of actions suited to them. They are slightly larger and clumsier than the real thing and obviously mechanical. The leg can run at Move 5 for 5 minutes or walk at move 2 for 8 minutes, after which 2 minutes are needed to rewind it; it has DX 7 and 2 HP, weighs 28 lbs., and costs \$43. The arm can manipulate objects with ST 8 for 3 minutes 45 seconds, after which 45 seconds are needed to rewind it; it has DX 4 and 3 HP, weighs 13 lbs., and costs \$350.

*Orrery:* This device, which gives +2 to Astrogation, simulates the orbital motions of the planets. It has two versions: a small hand-cranked model (15 lbs., \$12.50) and a larger model powered by steam (300 lbs., \$50).

*Slide Rule:* Allows a  $\times 10$  increase in the speed of calculations involving multiplication and division, powers and roots, or logarithms. Weight negligible; cost \$2.50.

*Telegraph Key:* The full equipment needed to send and receive messages on a telegraphic line, available after 1840. Weight 3 lbs.; cost \$2.50. The receiver alone, useful for tapping enemy communication in battle (for example), weighs 2 lbs. and costs \$1.25.

*Typewriter:* Available after 1880, the typewriter revolutionizes office work; the skill of Typing becomes essential for many careers. A typical model weighs 15 lbs. and costs \$5.



## CLOTHING AND ARMOR

*Cloak:* Advanced TL(5+1) chemical technology allows the formulation of extraordinarily tough fiber. A heavy cloak of fabric woven from such fiber provides PD 2 and DR 2. It takes 3 points of impaling damage to penetrate it and 7 points of cutting damage to make it useless. Weight 5 lbs.; cost \$50.

*Diving Dress:* A suit designed for hard hat diving, available after 1830. It needs to be supplied with air from a pump on the surface worked by two men (or an experimental mechanical compressor). Weight: suit 150 lbs., pump 100 lbs., hose 1 lbs./10'; cost \$25 with 100' hose.

*Nullsuit*: Based on gravity screen materials (see p. 99), the nullsuit allows the wearer greatly enhanced mobility and personal safety. A single-piece garment covers the wearer from head to foot; area for a person of average size is 18 sf. Three standard qualities are available: 1/2 G (\$90), 1/10 G (\$810), and 1/100 G (\$8,910). Weight is 10 lbs. before the screen factor is applied.

A nullsuit lets its wearer jump farther and withstand falls from greater heights. For falls, multiply the distance fallen by the G factor to get the effective height. For jumps, divide the jumper's jumping range by the G factor to get the range while wearing the nullsuit. A nullsuit wearer falls with

dreamlike slowness; stepping off an upper story won't result in fast escape! A more detailed treatment can use the rules in *GURPS Space* (pp. 97-100). Nullsuits are useful to mountain climbers and burglars, but are also worn by wealthy men who have put on weight from rich food.



*Steel Skullcap*: Designed to be worn under a hat, the skullcap provides PD 2 and DR 4 against head blows (hit locations 3 and 4). Weight 3 lbs.; cost \$5.

*Vacuum Suit*: The basis for survival in outer space, this TL(5+1) suit weighs 50 lbs. and costs \$100. Air hoses weigh 1 lbs./4'.

## THE CHEMIST'S SHOP

Two lists of pharmaceuticals follow. The first includes substances that were actually available in the 19th century; the second includes possible inventions, of value 15 points if not otherwise noted. Chemical substances other than pharmaceuticals form a separate list. For many of these drugs, apply the toxicity rules in Chapter 4 (p. 63).

### TL5 DRUGS

#### *Arsenic*

Arsenic was used as a purgative, to cause vomiting and diarrhea. It is also toxic to microorganisms causing a variety of diseases, from amoebic dysentery to syphilis. Apply the toxicity rules. Symptoms of poisoning include pain in the digestive tract and bloody diarrhea. Arsenic is retained in the body; reduce HT permanently by half the immediate loss, rounded down. It is widely believed that small doses of arsenic can build up an immunity. In a realistic campaign this will not be true, but in a cinematic one it may be. Cost is \$0.01 per dose.

#### *Calomel*

Calomel is mercurous chloride, given for a wide range of ailments and actually effective against syphilis. Apply the toxicity rules. Symptoms of poisoning include vomiting, diarrhea, and a metallic taste in the mouth. Toxicity exceeding half of HT causes salivation and loosened teeth; roll against HT, with one tooth falling out for each point of failure, or serious facial deformity resulting from critical failure. Because of the digestive effects, it is often given as a purgative. Cost is \$0.01 per dose.

#### *Carbolic Acid*

Disinfectants came into use in the 19th century with the germ theory of disease; carbolic acid (phenol) is a typical example. Used on a newly inflicted wound, acids are actually less effective than simply washing with clean water (-1 to the roll to avoid infection, p. B134), as they damage healthy tissue. However, if the wound is already infected, they can be beneficial. Use the toxicity rules, but toxic effects are localized hit point damage rather than generalized HT loss. Cost is \$0.05 for a bottle good for 12 treatments.

#### *Cocaine*

An alkaloid extracted from the leaves of the coca plant of South America. Its stimulant effects give +1 to Speed, combined with the Impulsive disadvantage, for half an hour. It also numbs areas to which it is applied, equivalent to High Pain Threshold. Habitual users may gain an Addiction, but normal doses are not toxic. Cost is \$0.05 per dose.

#### *Opium*

Extracted from poppies, opium is the 19th century's most widely used medicine and one of its safest. It suppresses pain and fear, giving +1 to fright checks, and can induce sleep; it is also taken for its sensual and hallucinatory effects. Habitual users may gain an Addiction, but normal doses are not toxic. Cost is \$0.01 per dose. Laudanum is its alcoholic extract and has similar effects.

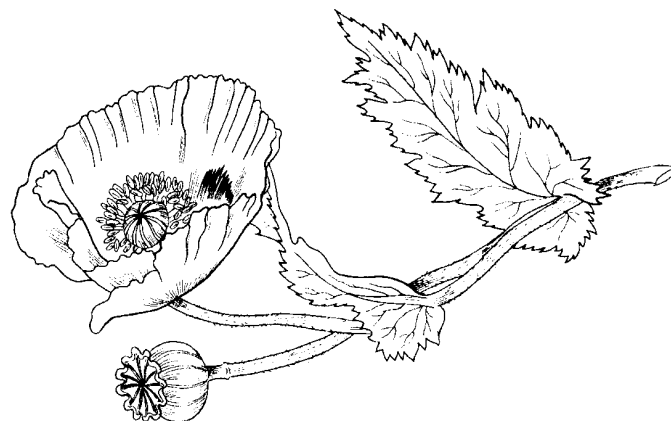

#### *Quinine*

This extract of cinchona bark suppresses malarial symptoms, though it does not cure the disease, which is likely to recur. Quinine can also lower a fever. Apply the toxicity rules, but a curative effect is always experienced, with toxic effects only on a failure; the usual toxic effect is blurred vision (Bad Sight) or ringing in the ears (Hard of Hearing). Acute toxicity causes respiratory paralysis or heart failure. Cost is \$0.02 per dose.

## Tartar Emetic

Antimony potassium tartarate has symptoms similar to those of arsenic and is also used as a purgative. It is an effective vermifuge. Toxicity has sedative effects, so the compound is sometimes used for this purpose and to treat drunkenness. Juries sometimes had to decide whether a dead man was given tartar emetic therapeutically or homicidally. Cost is \$0.01 per dose.



## TL(5+1) DRUGS

These drugs are the products of TL(5+1) medicine; in a TL5 society they would not exist unless some genius invented them (and it would cost 15 points to have done so), whereas in a TL(5+1) society some of them would already exist, and the rest would be 5-point inventions.

### Acetylsalicylic Acid

Historically invented 1899 and trademarked as Aspirin, this TL(5+1) compound is safe for internal use, in contrast to salicylic acid, which is a stomach irritant. Acetylsalicylic acid causes 1 point of HT loss on a critical failure only. It reduces chronic pain, inflammation, and fever – it is automatically successful for minor conditions, but a Physician or Pharmacy roll is required for severe conditions such as Migraine. Cost is \$0.01 for a normal daily dose. Phenacetin (a precursor of acetaminophen) has similar effects, but its characteristic toxic side effect is liver damage.

### Arsphenamine

One of the first compounds that contained safer forms of inorganic poisons, this antisyphilitic drug, trademarked as Salvarsan, has half the toxic effect of arsenic, rounded down. The arsenic is excreted safely. Cost is \$0.05 per dose.

### Atavismine

This drug produces temporary evolutionary regression to a more primitive state ruled by impulse (see the sidebar *Alternative Theories of Evolution*, pp. 100-103). Its users, such as the unfortunate Henry Jekyll, acquire a temporary Split Personality at the 15-point level. Basic IQ is unchanged,

but psychological traits that reflect self-control and humanity are lost (for example, Empathy, Code of Honor, and Sense of Duty), while traits that reflect impulsiveness and brutality become worse (for example, Bad Temper to Berserk) and new ones may be acquired. Finally, the user's appearance changes, making him unrecognizable; in the process he becomes one level less attractive through a subtle quality of deformity. A Will roll is required each time the drug is taken; on a failure the user becomes addicted, on a critical failure he becomes vulnerable to flashbacks (treat as Split Personality), and on a natural 18 the atavistic personality becomes the baseline personality. Cost is \$0.05 per dose.

## Growth Stimulants

A course of growth stimulant (see p. 104) costs \$5,000 × (height factor - 1), spread over the growth period. If given during the adolescent growth spurt, it cannot produce a height factor above 1.5. If given during adult life, it produces acromegaly, which combines Unattractive appearance with -1 DX due to enlarged joints (total -15), but no overall growth.

Two specialized variants on growth stimulant may also be created. Muscular growth stimulant can be equated to anabolic steroids; a course of treatment costs \$10,000 (see p. BIO73). Neural growth stimulant is described under *Making Men from Animals* (pp. 100-101); a course of treatment costs \$25,000.

## Bactericide

Microorganisms often produce compounds toxic to other microorganisms. Pasteur experimented with the medical use of such compounds, but found them equally toxic to human patients. Had he discovered some compound such as streptomycin, the antibiotic era might have started decades earlier with substances extracted from soil bacteria. Apply the toxicity rules, but any success will completely cure a bacterial infection. Cost is \$1.00 for a complete course of treatment lasting 10 days.





Any success produces unconsciousness in 1 minute for a willing subject or 5 minutes for an unwilling subject; a critical success takes half as long. On a critical failure, the subject stops breathing and must be revived by another Physician roll or die.

No anesthetic is perfect. Nitrous oxide does not produce full unconsciousness, but gives +1 to withstand pain per point of success and produces an enjoyable delirium. Chloroform is harmful to the liver; rolls to recover from HT damage are at -5. Ether is safe and effective, but inflammable. Cost is \$0.05 per dose for any of these.

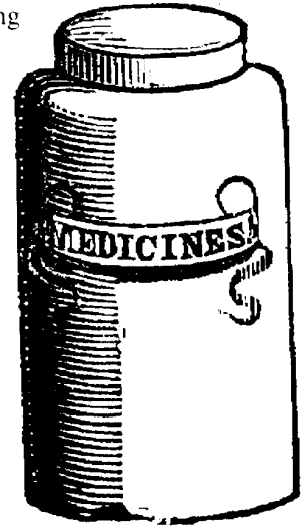

### **Metacocaine**

Metacocaine is an improved stimulant derived from coca, granting Enhanced Time Sense and +2 Speed. It does not produce the Impulsive disadvantage, though the user may *look* impulsive to others! Communication is difficult, with effects comparable to Disturbing Voice from rapid speech. Effects last approximately 10 minutes and cause 1 fatigue. Cost is \$0.25 per dose.

### **Sulfanilamide**

An antibacterial drug based on inorganic toxicity, sulfanilamide can be used with comparatively low risk; patients experience 1 point of toxicity on a critical failure. Cost is \$0.05 per dose.

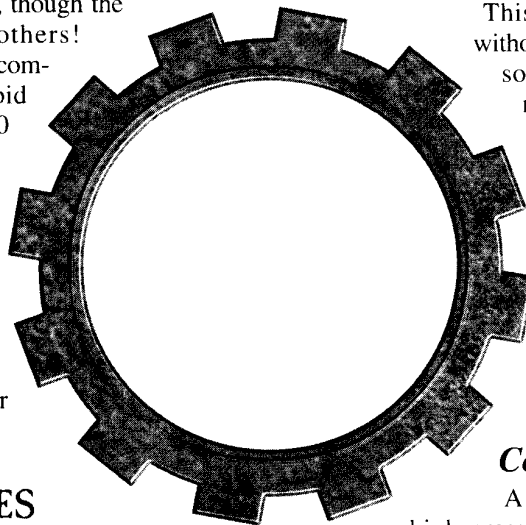

### **Chemical Rebreather**

This technique keeps air breathable without compressed air tanks or a power source. Heated potassium chlorate releases oxygen; shaken potassium hydroxide combines with carbon dioxide to form potassium bicarbonate. Per man-day, this requires 10 lbs., 0.2 cf, and \$2.50. This includes enough oxygen to support gaslamps and gas heat to keep the system working. Power consumption is negligible. (See the Lunar Shell on p. 83.)

### **Compressed Air**

A heavy tank containing air under high pressure, sufficient for one man for 6 hours, weighs 36.5 lbs. and costs \$50.

## **CHEMICAL SUBSTANCES**

### **Acids**

Strong acids such as hydrochloric, nitric, or sulfuric acid cause 1d-1 damage to unprotected skin or most metals. If the eyes are targeted and hit, or if the face is hit and the victim fails to make a HT roll, more than 2 points of acid damage causes blindness, which may be temporary or permanent according to the rules for crippling damage (p. B129). Cost is \$0.05 per shot (a shot is about 4 pints).

### **Anesthesia**

Inhalation anesthetics include chloroform, ether, and nitrous oxide. Chloroform is available after 1831, and the other two throughout the period, but their surgical use began in 1847. Apply the toxicity rules (p. 63) when they are used, but with actual HT damage divided by 2, rounded down – for normal doses, except on a critical failure, there is no actual toxic effect.

### **Nitroglycerine**

Synthesized in 1846, nitroglycerine was the first high explosive (that is, a substance that can explode without a container). Its concussive damage is 6d×3 per pound. "Nitro" is touchy stuff that requires careful handling. If it is dropped or shocked, roll 3d; it explodes on 13 or higher if chemically pure, on 12 or higher if contaminated. (See pp. HT2-29 for more information on nitroglycerine and dynamite, which was also available during this period.)





# CHAPTER 6 WEIRD SCIENCE

*This ray, like the ninth ray, is unknown on Earth, but the Martians have discovered that it is an inherent property of all light no matter from what source it emanates.*

*— Edgar Rice Burroughs, A Princess of Mars*



The inventions described in Chapter 5 reflect two sources: the real possibilities of 19th-century technology, and the possibilities that the 19th century imagined, but that are now known to violate the laws of nature. But what if the laws of nature were different? The scientific theories and speculations of the 19th century implied many things that seem utterly strange a hundred years later. This chapter explores several of those theories and the gaming possibilities they suggest.

## THE LUMINIFEROUS ETHER

In the 19th century, light was shown to be a form of wave, like sound or mechanical vibration. But if there was a wave, physicists reasoned, something had to be waving. For sound, it was air. For mechanical vibrations, it might be any solid material. What was it for light? Light could travel between the planets and even between the stars, where no matter could be detected, not even air. This led physicists to believe it was carried by some peculiarly tenuous form of matter, so thin that solid planets could pass right through it unhindered. They named this substance the *luminiferous ether* (“luminiferous” means “carrying light”).

Michael Faraday’s experiments and James Clerk Maxwell’s theories showed that electric and magnetic fields could interact to produce a wave. Its speed could be calculated and turned out to be the same as the speed of light. Maxwell modeled electric and magnetic fields as strains in the ether. Heinrich Hertz’s spark gap transmitter seemed to prove that Maxwell was right. Albert Michelson and Edward Morley’s 1887 experiment cast doubt on the ether’s existence, but scientists only fully rejected it with the advent of relativity and quantum mechanics in the 20th century.

But what if the ether were real? A universe where light and radio were carried by the ether would have some interesting differences from ours.

## PROPERTIES OF THE ETHER

There are two different kinds of waves: longitudinal and transverse. Sound is a longitudinal wave: air molecules move forward, bunching up and forming a small volume at high pressure, and then recoil backward, while the new molecules they pushed into move forward in turn. Each bit of air moves backward and forward along the direction the sound wave is moving. On the other hand, if a guitar string is plucked, each section of the guitar string moves up and down, at right angles to the length of the string down which the wave travels; that is, the motion of the string is a transverse wave.

A fluid such as air or water can only carry longitudinal waves. A solid such as steel or diamond can carry both longitudinal and transverse waves. But light is a purely transverse wave with no longitudinal aspect. So the ether can’t be a gas, or even an ordinary solid, but it is as much more rigid than diamond as diamond is more rigid than water. The high speed of light indicates that the ether has very high stiffness, very low density, or both.

Finally, the ether does not interact with ordinary matter through any sort of mechanical impact; the two pass right through each other. Only electrically charged matter can influence the ether.

## NEW ELEMENTS

The discovery of new chemical elements picked up speed in the 18th century and continued through the 19th century. For a long time after this, writers who wanted a scientific-sounding rationale for some fantastic invention – anything from antigravity to direct conversion of matter to energy – needed only to say that it was produced by “a new element.”

Dmitri Mendeleev encouraged such speculation when he proposed the Periodic Table in 1869. Based on the chemical properties of the elements, he left three gaps in his table, predicting that new elements would be found to fill them. When scandium, gallium, and germanium were isolated, they had almost exactly the properties he predicted. The later discovery of helium and argon led to prediction of the properties of neon, krypton, xenon, and radon, adding another column to the Periodic Table. It seemed plausible that a fictional scientist could theorize the existence of a new element, predict its properties, and work systematically to isolate it, rather than just stumbling across it.

For one example, before the discovery of radioactivity, there was no reason to suppose that transuranic elements didn’t exist in nature; they might just be extremely rare. A conservative guess would have them be metallic, dense, and chemically unreactive; a wilder guess might give them almost any properties that were needed for a story.

## MYSTERIOUS RAYS

In 1895, the German physicist Wilhelm Conrad Röntgen, experimenting with cathode-ray tubes, discovered a mysterious new form of radiation, which he called X-radiation; the discovery earned him the first Nobel Prize in physics, granted 1901. In 1903, while trying to produce polarized X-radiation, the French physicist René Blondlot discovered another new form of radiation, with even more mysterious properties, which he named N-radiation in tribute to his native city of Nancy. N-rays were emitted spontaneously by all materials except green wood and anesthetized metal (metal treated with an anesthetic such as ether), they were refracted by aluminum, and they caused fluorescence in threads coated with calcium sulfide. The French government endorsed his scientific achievement, and other French scientists rushed to study the new rays and publish papers on them.

*Continued on next page . . .*

## MYSTERIOUS RAYS

(Continued)

Physicists elsewhere found Blondlot's results difficult to replicate; French scientists dismissed their skepticism, suggesting that German physicists had dulled their senses by drinking too much beer!

Eventually the British journal *Nature* asked an American physicist, Robert Wood, to visit Blondlot's laboratory and published his negative report, which showed that Blondlot and his assistant were victims of wishful thinking.

As this episode illustrates, radiated energy was poorly understood in the Age of Steam. New rays with mysterious properties justified a variety of marvels in works of fiction. They could even be explained as products of new elements, with radium as a precedent. A cinematic treatment of science could feature such rays: Blondlot's discoveries might even be vindicated in some alternate world.

## WHAT MAKES THE SUN SHINE?

A leading 19th-century opponent of evolution, the physicist Lord Kelvin, argued on the basis of thermodynamics that the earth could not be as old as biologists and geologists believed. Kelvin pointed out that the mass of the sun was known, the kinetic energy that would be produced by that mass' gravitational collapse from infinity could be calculated, and the rate at which the sun radiated energy away was known; these set an upper limit on the age of the sun – in the neighborhood of 100 million years, too short for much evolution. Darwin found this argument troubling; one of his notes described Kelvin as an "odious spectre." (This same assumption underlies the sun dying in a few million years in Wells' *The Time Machine*.)

The one thing that could refute his argument, Kelvin admitted, was a new energy source. In reality that energy source was nuclear fusion at the center of the sun. GMs who assume etheric physics or some other alternative science may want to work out a different energy source. For example, the intense pressure inside the sun might produce an ongoing state of etheric shock. Alternatively, GMs may want to assume a relatively young earth and some process that causes rapid evolution.

## WIRELESS TELEGRAPHY

Hertz's experimental spark gap transmitter led fairly quickly to practical engineering, as Guglielmo Marconi, Nicola Tesla, and others worked to develop wireless telegraphy. Equipment required is as follows (all equipment is TL(5+1)):

### Wireless Communicator

Device	Weight	Cost	Range	Power
Receiver	2	\$1	10	0.01
Transmitter	9	\$10	10	0.1
<b>Range</b>				
Very Short	×0.1	×0.1	×0.1	0
Short	×0.25	×0.25	×0.3	×0.1
Medium	×1	×1	×1	×1
Long	×10	×3	×3	×4
Very Long	×100	×10	×10	×10
<b>Options</b>				
Voice	×1	×2	×1	×1
Vision	×10	×10	×1	×3
Matter	×100	×100	×1	×10

*Notes:* Weight is in pounds. Volume in cf is equal to weight/50. Range is in miles. A standard receiver and transmitter have range 10 miles; apply the multipliers for both the receiver and the transmitter to find the actual range (for example, a long range receiver, ×3, can detect a very long range transmitter, ×10, at ×30 range, or 300 miles. The Very Short option is available only for receivers and only for telegraphy or voice; it represents a crystal set without batteries or other power. Power is in kW.

Wireless voice transmission is a 5-point Invention at TL(5+1) or a 15-point Invention at TL5. Wireless vision transmission is a 15-point Invention. Wireless matter transmission, if the GM decides that it is possible, is a 50-point Invention. In a universe where life is based on élan vital (see sidebar, p. 98), a matter transmitter produces a dead copy of any living organism on which it is used, as the élan vital is not material. Of course, a corpse exactly resembling a living person could be useful.

## REACTIONLESS DRIVES

If electric and magnetic fields are strains in the ether, then electricity and magnetism can exert force on the ether. The right sort of apparatus might be able to exert much more intense forces. This would create an equal and opposite force on the apparatus – it would be pushing against "empty space," which would make it a reactionless drive. Two models might be available:

### Reactionless Thrusters (TL(5+1))

Type	Weight	Power	Cost
Standard Thruster	1 ×thrust	0.5	\$5
Super Thruster	0.4 ×thrust	0.5	\$25

Another application for reactionless thrust is a hollow sphere whose interior generates outward thrust. Thrust equal to atmospheric pressure could inflate a gasbag containing no gas at all, allowing static lift superior even to that of hydrogen: 13.4 cf per pound of lift. No gas or ballast is consumed in the

process, but it does take energy to inflate the gasbag: 40 kW per pound of lift. The apparatus that generates the force weighs 0.2 lbs. and costs \$0.25 per square foot of surface (see p. VE18 for a table converting volume to surface, or use the formula  $6 \times [(\text{cube root of volume in cf})^2]$  to find surface in sf).

## ETHERIC SHOCK

In classical physics, which the ether theory is part of, the speed of light is not a natural speed limit, as it is in relativistic physics; it simply happens to be the speed at which ether waves travel. Going faster than light is not impossible but merely very difficult.

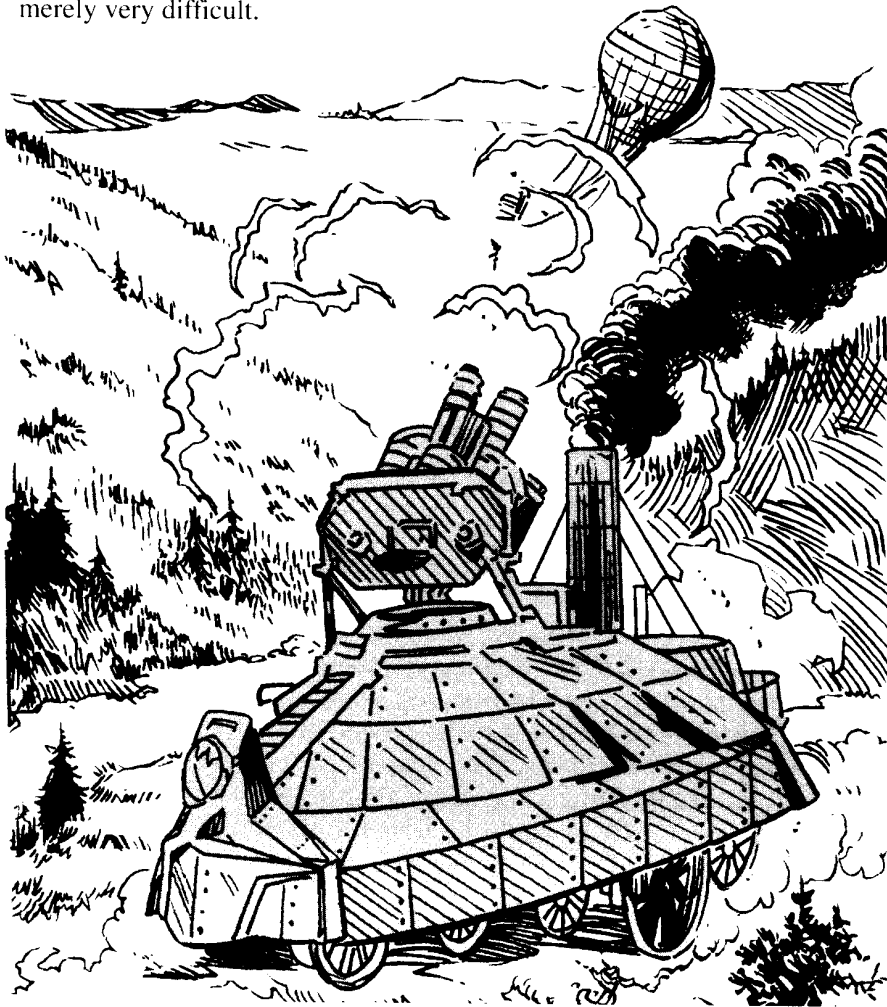

Etheric shock waves correspond to light waves as explosive shock waves correspond to ordinary sound waves. They travel at superluminal speeds, creating incredibly high tensions that overcome the elastic limit of the ether, changing it from a hypercrystal into an ordinary crystal that can carry longitudinal as well as transverse waves – i.e., they change the vacuum from an insulator into a conductor. Any matter in their path suffers the disruptive effects of extremely high electric currents.

The simplest etheric shock devices produce spherical wave fronts that dissipate their energy after expanding outward a short distance. More advanced devices can project beams to a considerable distance. Effects are comparable to those of charged particle beams (see pp. VE123-127). Several models are defined in Chapter 5 (p. 89); design rules are given here.

## HABITABLE PLANETS

Little was known about other planets in the 19th century; astronomers imagined them in terms of the only planet they were really familiar with: Earth. The atmospheres of Mars and Venus, for example, were thought of as oxygen-based, though Mars' might be thin and Venus' thick. The result is a solar system much friendlier to human explorers and colonists than the real one. In a steampunk universe, this might be the real solar system; see Chapter 7 for descriptions of these planets.

Many scientists thought Mars was older than Earth, and Venus and Mercury were younger. This was based on the nebular hypothesis, according to which the solar system came into being when a cloud of interstellar gas and dust collapsed to form the sun, leaving behind rings that formed planets. The outer rings would have been released earlier and thus the outer planets would be older. This suggested an ancient, dying Mars with its air and water lost into space; a steamy, Mesozoic Venus; and a Mercury still molten, like the early Earth. This view was encouraged when Giovanni Schiaparelli drew a map of Mars with *canali* (channels) and Percival Lowell interpreted these as canals deliberately built by ancient engineers to irrigate a drying world. Some theories made the asteroids the remains of a very old planet destroyed in some cosmic catastrophe.

A rival theory said the planets formed when another star passed so close to the sun that its gravity pulled masses of solar matter into space, where they cooled to form the planets. If this were true, the planets would all be the same age; ancient Martians and primitive Venerians could be forgotten.

## SUNKEN CONTINENTS

Geology and paleontology showed that parts of continents had been submerged in the prehistoric past. The idea that continents could move about on the Earth's surface was not proposed until 1912, and not accepted until the 1960s. In the 19th century, scientists favored a different theory; that parts of the Earth's crust moved up or down over time, rising above sea level or sinking below it. Paleontologists explained the geographic distribution of extinct animals by proposing that "land bridges" had connected various continents and then been submerged again.

Speculative Victorian writers revived the Atlantis legend and added Lemuria and Mu (pp. PM6-17). Any theory that had these continents sinking during historic times, or any time during the existence of *Homo sapiens*, hugely exaggerated the pace of geological change. A cinematic steampunk campaign may still use them; a realistic one should not.

## ÉLAN VITAL

What makes living things live? The dominant view in the 20th century is mechanism: life is a complex organization of matter and energy that acts according to the ordinary laws of physics. In the 19th century, mechanists were less common; many biologists were vitalists, believing that living matter was animated by a special force, the *élan vital*.

Before 1828, it was thought that certain compounds could only be formed by the unique forces within living tissues; these compounds were called "organic." Inorganic compounds such as minerals changed form when heated but returned to the original form when cooled; organic compounds did not change back, seeming to show that it took more than physical forces to create them. This was disproved when Friedrich Wöhler synthesized urea, and organic chemistry was redefined as the chemistry of carbon compounds. This success inspired some chemists to dream of synthesizing life (see *Making Men from Chemicals*, p. 103). Perhaps one special molecule could animate dead matter. As a variant, after he discovered that certain organic molecules occurred in left-handed and right-handed forms and that life only used one form of each molecule, Pasteur speculated that asymmetry might be the secret of life and spent considerable time exposing carbon compounds to magnetic fields; the lack of results convinced him that life could not originate spontaneously from unliving matter.

Other speculations emphasized electricity, inspired by Luigi Galvani's discovery that electric current made dead muscle tissue twitch. Nearly every film version of *Frankenstein* has shared this assumption — though obviously simple electricity can't be the secret of animation; some special way of applying it would be necessary.

A different line of thought derived from Anton Mesmer's discovery of hypnosis in the 18th century. The hypnotist's influence over the subject was often thought of as a physical force, "animal magnetism," that could override the normal mental and even physiological functions of the subject. Experimenters hypnotized subjects at a distance or through an opaque screen to show that animal magnetism's properties paralleled those of ordinary magnetism. Charismatic people were described as "magnetic" (see p. 104). Maxwell's concept of the ether and Hertz's demonstration of radio waves suggested further ideas along these lines.

*Continued on next page . . .*

## Etheric Shock Beam Weapons

To design an etheric shock beam weapon, select a beam output in kilojoules (kJ), a number of seconds between shots, and a range, which may be close, normal, long, very long, or extreme. The minimum output is 1,000 kJ. The weapon malfunctions on a 16 or higher. Damage is computed as  $1.6 \times$  (square root of  $O$ ), where  $O$  is beam output in kJ; damage type is Imp. Half damage range is (cube root of  $O$ )  $\times R \times 15$ , where  $O$  is beam output in kJ and  $R$  is 8 for an extreme range weapon, 4 for a very long range weapon, 2 for a long range weapon, 1 for a standard weapon, and 0.25 for a close range weapon; maximum range is  $1.25 \times$  half damage range. Accuracy depends on half damage range:

### Etheric Weapon Range

Range	Acc
Below 150	11
150-199	12
200-299	13
300-449	14
450-699	15
700-999	16
1,000-1,499	17
1,500-1,999	18
2,000-2,999	19
3,000-4,499	20
4,599-6,999	21
7,000-9,999	22
10,000-14,999	23
15,000-19,999	24

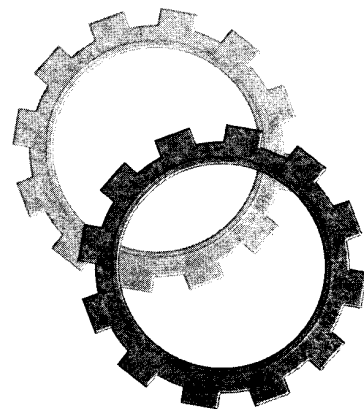

Power requirement in kW is  $2 \times$  beam output in kJ, divided by the number of seconds per shot; power is normally supplied from a generator, but a small weapon may be powered by batteries. Weight is computed as  $(O/72) \times S \times R$ , in pounds, where  $S$  is 0.5 if output is 6400 kJ or less and 1 otherwise, and  $R$  is 4 for extreme range, 2 for very long range, 1.5 for long range, 1 for standard range, and 0.666 for close range. Cost is \$50 + \$10 per pound for weight under 10 lbs., \$15 per pound for weight 10-100 lbs., \$1,000 + \$5 per pound for weight over 100 lbs. Snap shot depends on weight:

Under 2.5 lbs.	SS 11
2.5-10 lbs.	SS 12
10-14 lbs.	SS 14
15-25 lbs.	SS 17
26-400 lbs.	SS 20
401-2,000 lbs.	SS 25
2,000+ lbs.	SS 30

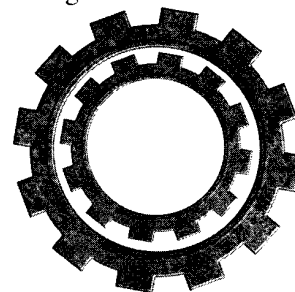

### Etheric Shock Bombs

An etheric shock device generating a simple spherical wavefront, equivalent to an explosion, also has a minimum output of 1,000 kJ. It causes  $2.4 \times$  (square root of  $O$ ) dice of damage at 2 yards; divide rolled damage by 4 for each further 2-yard interval. Weight of the apparatus is 1.75 lbs. per 1000 kJ. This does not count the weight of batteries; each kJ of output requires batteries storing 2 kW.

# ANTIGRAVITY

Most portrayals of antigravity treat it as a form of reactionless drive. An approach in the spirit of 19th-century classical physics suggests at least two different sets of properties that could be called “antigravity,” each having different effects. Either sort would be a 50-point Invention.

## GRAVITY SCREENS

A gravity screen is a chemical substance or a mechanical or electromagnetic process that insulates against gravity. Placed between two masses, it lessens their gravitational effect on each other, the way an electrical insulator lessens the electrical force between two charged surfaces. The effectiveness of a chemical substance depends on its purity, but purer material is also much more expensive; similarly, the power consumption of a mechanical screen (supplied by clockwork or steam) or an electromagnetic field (supplied by batteries) increases sharply with effectiveness:

### Gravity Screen

Weight Reduction	Cost per sf	Power per sf
10%	\$0.56	0.11 kW
20%	\$1.25	0.20 kW
30%	\$2.14	0.43 kW
40%	\$3.33	0.67 kW
50%	\$5.00	1 kW
60%	\$7.50	1.5 kW
70%	\$11.67	2.3 kW
80%	\$20.00	4 kW
90%	\$45.00	9 kW
95%	\$95.00	19 kW
99%	\$495.00	99 kW
99.9%	\$4,995.00	999 kW

An object with reduced weight also has lower escape velocity, equal to 25,200 mph multiplied by the square root of (1 - weight reduction fraction). For example, 99% weight reduction (weight reduction fraction of 0.99) lowers escape velocity to 2,520 mph.

Any sort of gravity screen was considered unlikely even in the 19th century, and fictional versions are usually flatly impossible. They typically have the same problems as later contragravity generators: conservation of energy problems caused by being able to enter or leave the screened vehicle without tremendous effort, and the mysterious ability to distinguish between the gravity of the Earth (which they screen against) and the gravity of the Sun and the rest of the universe (which they don't block).

### Gravitic Balloons

One of the most effective uses of this antigravitic technology, ironically, applies it to a relatively small mass. If the outer wall of a gasbag is coated with a gravity screen – such as a paint made from some exotic chemical or a metal foil to carry some electromagnetic influence – the weight of the air it contains is decreased, making it lighter than air! The resulting aerostatic lift can be calculated in two steps:

$$\text{Buoyancy} = 72.6 \times \text{Weight Reduction Percentage}$$

$$\text{Volume} = 1,000/\text{Buoyancy}$$

## ÉLAN VITAL

(Continued)

At the GM's discretion, any of these ideas may turn out to be true.

If there were some way to isolate the principle of life, it could have many applications: healing injuries, stimulating growth and fertility, or prolonging life. In a superscience campaign, *élan vital* might animate unliving organic matter or confer superhuman powers. Misapplied *élan vital* could create deformed and monstrous creatures, induce cancerous growths, or cause other forms of harm.

The control of life could create new social conflicts as well. If the prolongation of life or the revival of the dead were expensive, and thus limited to the rich, a long-lived elite might rule over short-lived masses, or face revolution inspired by resentment of its privileges. The creation of synthetic life might threaten workers with obsolescence, inspiring violence against the synthetic laborers or the laboratories that made them.

For an exotic variant on this theme, the mysterious “chi” described by Chinese alchemists, martial artists, and physicians may actually be the *élan vital* hypothesized by Western science. A Western character with an Unusual Background might have chi powers, or a Western scientist working on the fringes of etheric biophysics might rediscover them in his laboratory.



In game terms, isolating the *élan vital* and infusing it into an appropriate vessel requires a roll against Alchemy-10, Biochemistry-10, Etheric Science-10, or Psychical Research-10, depending on the assumptions of the campaign; the procedure will never be routine. Any artificial life form will be a 50-point invention.



The starting point for this process is an existing animal species, which should be defined as a racial template (see pp. BIO99-100 and CI173-180). The best starting points are species with IQ 5 or 6, though good sensory or manipulative organs or sophisticated social behavior may help.

The animal's body may be reshaped into a more useful form; this is called *anthropomorphization*. Major improvements include changing posture from Horizontal to Semi-Upright or from Semi-Upright to Upright; changing No Fine Manipulators to Bad Grip, Bad Grip to Poor Grip, or Poor Grip to normal abilities; and changing Mute to Disturbing Voice (equivalent to Stuttering) or Stuttering to normal speech. This process will shape most animals into at least crude simulacra of the human shape.

Anthropomorphization will do nothing for the animal's mental abilities, unless the GM assumes that, for example, the ability to speak evokes the brain functions needed to use speech – a highly cinematic idea! In general, it will be necessary for the animal to undergo *sapientization*: having IQ raised, having the Presentient disadvantage bought off, and having racial mental disadvantages mitigated or bought off. This can be done without anthropomorphization, though the two often go together.

One way to make such changes is through *eugenics*, by selective breeding for desirable traits (see sidebar, p. 104). This will take generations, too long to fit into most campaigns, though the referee may assume that it has already been going on for some time, especially in a TL(5+1) world.

Surgery is faster, but riskier; roll against Surgery at -5 to change each of posture, manipulation, and voice. A critical failure kills the subject; an ordinary failure produces no improvement and requires healing before further attempts; an ordinary success produces the desired result; a critical success produces an extra step of improvement, if possible. For a note of horror, the surgery can be performed without anesthesia, using the rules on pp. 64-65.

## ALTERNATIVE THEORIES OF EVOLUTION

(Continued)

### MACROMUTATIONS

Some differences between groups of living organisms seemed so massive that 19th-century biologists found it hard to imagine one turning into the other through natural selection. Hugo de Vries suggested that species underwent sudden massive changes in form, turning all at once into a different species (Olaf Stapledon's *Odd John*, which coined the term *Homo superior*, made this assumption). The discovery of X-rays and their mutagenic effects helped make this plausible.

In game terms, macromutations can justify either a nascent subspecies of human beings (or of animals or plants), or characters with "mutant" powers in the late 20th-century comic-book sense. Powers with plausible biological mechanisms best fit the 19th-century idiom. Referee approval should be required for any character to enter play with such powers.

*Continued on next page . . .*



The starting point for this process is an existing animal species, which should be defined as a racial template (see pp. BIO99-100 and CI173-180). The best starting points are species with IQ 5 or 6, though good sensory or manipulative organs or sophisticated social behavior may help.

The animal's body may be reshaped into a more useful form; this is called *anthropomorphization*. Major improvements include changing posture from Horizontal to Semi-Upright or from Semi-Upright to Upright; changing No Fine Manipulators to Bad Grip, Bad Grip to Poor Grip, or Poor Grip to normal abilities; and changing Mute to Disturbing Voice (equivalent to Stuttering) or Stuttering to normal speech. This process will shape most animals into at least crude simulacra of the human shape.

Anthropomorphization will do nothing for the animal's mental abilities, unless the GM assumes that, for example, the ability to speak evokes the brain functions needed to use speech – a highly cinematic idea! In general, it will be necessary for the animal to undergo *sapientization*: having IQ raised, having the Presentient disadvantage bought off, and having racial mental disadvantages mitigated or bought off. This can be done without anthropomorphization, though the two often go together.

One way to make such changes is through *eugenics*, by selective breeding for desirable traits (see sidebar, p. 104). This will take generations, too long to fit into most campaigns, though the referee may assume that it has already been going on for some time, especially in a TL(5+1) world.

Surgery is faster, but riskier; roll against Surgery at -5 to change each of posture, manipulation, and voice. A critical failure kills the subject; an ordinary failure produces no improvement and requires healing before further attempts; an ordinary success produces the desired result; a critical success produces an extra step of improvement, if possible. For a note of horror, the surgery can be performed without anesthesia, using the rules on pp. 64-65.

## ALTERNATIVE THEORIES OF EVOLUTION

(Continued)

### MACROMUTATIONS

Some differences between groups of living organisms seemed so massive that 19th-century biologists found it hard to imagine one turning into the other through natural selection. Hugo de Vries suggested that species underwent sudden massive changes in form, turning all at once into a different species (Olaf Stapledon's *Odd John*, which coined the term *Homo superior*, made this assumption). The discovery of X-rays and their mutagenic effects helped make this plausible.

In game terms, macromutations can justify either a nascent subspecies of human beings (or of animals or plants), or characters with "mutant" powers in the late 20th-century comic-book sense. Powers with plausible biological mechanisms best fit the 19th-century idiom. Referee approval should be required for any character to enter play with such powers.

*Continued on next page . . .*



## ALTERNATIVE THEORIES OF EVOLUTION

(Continued)

### ORTHOGENESIS AND RACIAL SENESCENCE

This theory derived from observation of fossil animals such as saber-toothed cats, which showed canine teeth of steadily increasing size, to the point that it seemed they must have inconvenienced their owners! Some biologists thought each type of organism had design tendencies that became steadily more exaggerated with each new species in the evolutionary line. In effect, they thought the evolution of species was like the maturation of individuals. One implication of this was that a species, genus, or family could become old, just as an individual could, losing its natural vigor.

This is not likely to affect human characters, but it provides a justification for the Dying Race disadvantage. Note that every story in which some ray or chemical creates "the man of the future" assumes that human evolution has a unique, predetermined path and an individual can be moved forward (or possibly backward) along that path.

*Continued on next page . . .*



Surgery to reshape the brain is more difficult; for it to work at all, the GM must assume that the brain has more ability to heal its own injuries than it has in reality. Successful surgery reassigns brain tissue from sensory or motor to higher cognitive functions; the IQ of the racial template increases, but the total points of Acute Senses, Alertness, or DX in the racial template are reduced by twice the cost of the added racial IQ. On a critical success, the points are simply transferred. On a failure the points are simply lost. On a critical failure the animal dies in 1d days. Surgery is at -1 per 5 points transferred (rounded up) in addition to the basic -5.

Another method is a brain tissue graft, which gives +1 or +2 to racial IQ, but requires a roll against HT-1 or HT-2, with failure meaning that IQ does not increase but decreases, while critical failure causes death in 1d days.

Another way to enlarge the brain is with neural growth stimulants (see p. 92). If these are given to unborn animals, they will gain 2 points of racial IQ. Alternatively, they can be given after sapientization surgery, with the result that IQ gain requires the loss of only an equal point value of other traits, or no loss at all on a critical success.

Other drugs may stimulate intelligence; treat these as mitigators (p. BIO137) for Absent-Mindedness, Confused, Distractible, Dull, Hidebound, Indecisive, Short Attention Span, or Staid, for species IQ with negative point costs, or for Presentience.

None of these processes (except eugenics) will affect future generations, except in a campaign with inheritance of acquired characteristics (see sidebar, p. 100). In weird science campaigns, an evolutionary stimulus that produces heritable changes may be possible.

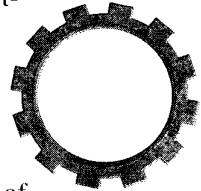

## MAKING MEN FROM CORPSES

A more difficult raw material would be human corpses. They have the advantage of already having the right shape, but once the undamaged parts are assembled the mosaic must be restored to life.

The process starts with obtaining the raw materials: dead bodies. Corpses can be bought from "resurrection men" following the usual rules for buying illegal goods (p. B64). A coroner or a surgeon working in a hospital may be able to divert bodies or parts of bodies, using Forgery or Administration; general administrative coverup may result in a Contest of Skills. A more adventurous scientist may go out and dig up bodies himself.

He must then reassemble the parts. A total of 1d+1 bodies are needed to obtain all the necessary parts (rolled by the GM). A Surgery roll is needed for each body that is used; one roll can be attempted per day (two per day if the surgeon is a Workaholic or Obsessed, with the usual reduced skill). Repeated attempts are possible after ordinary failure; critical failure leaves the salvaged parts too damaged for further attempts, and a new source body must be obtained. GMs should feel free to detail exactly which parts are obtained from which body.

Finally, the scientist must reanimate the reassembled body (see *Élan Vital*, pp. 98-99).

## MAKING MEN FROM CHEMICALS

The discovery that it was possible to synthesize organic compounds in the laboratory suggested that it might be possible to synthesize living organisms themselves. The resulting beings can be built as androids (see pp. BIO24-59). Again, they will probably look human, though perhaps with odd skin color or texture or a strange metabolism. Since 19th-century chemists had little understanding of proteins and had never heard of DNA, this feat requires either radically different biochemistry or a chemical élan vital (see sidebar, pp. 98-99).

## PSYCHICAL RESEARCH

The Victorian era saw the first attempts to investigate apparently mystical or supernatural experiences scientifically. The accepted term is “psychical research” – the term “parapsychology” was not coined until after the Great War, and “psionics” came even later. The Society for Psychical Research, founded 1882 in England, and the American Society for Psychical Research, founded 1885, investigated telepathy, clairvoyance, and even survival after death. Many of the abilities described in *GURPS Psionics* are familiar ideas in this period, but often the names are different.

The concepts often differ as well. On one hand, as the investigation of survival after death illustrates, no sharp line was drawn between unexplored natural phenomena and the supernatural. On the other hand, physical forces such as electricity and magnetism were still mysterious, and such phenomena as telepathy could be explained in terms of the ether. If the GM chooses, advanced etheric devices may enhance the powers of the mind or even reveal the spirits of the dead.

## PSYCHIC POWERS

To define psychic powers in contemporary terms, use the following modifications to *GURPS Psionics* (pp. P10-31):

*Antipsi Power* – not available.

*Astral Projection* – no change.

*Electrokinesis* – not available.

*ESP Power* – change name to Clairvoyance.

*Healing* – divide into two powers: Body Control, 2 points per level, self only, cannot use Sense Aura or heal others; Healing, 2 points per level, others only, cannot use Life Extension or Metabolism Control.

*Psychic Vampirism* – no change.

*Psychokinesis* – change name to Mind over Matter.

*Telepathy* – change name to Thought Transference.

*Teleportation* – not available.

In other words, the psychic powers defined by this period’s science are Astral Projection, Body Control, Clairvoyance, Healing, Mind over Matter, Psychic Vampirism, and Telepathy. The same skills are generally available, but finding a teacher may be extraordinarily difficult; a character who starts out already trained should have an Unusual Background. If the GM allows psychic powers, characters should generally be limited to Power 5 or less; Power 10 should be awe-inspiring.

For a variant treatment of psychic powers, more in keeping with 19th-century theories, use the following advantage:



## ALTERNATIVE THEORIES OF EVOLUTION (Continued)

### RECAPITULATION

In the late 19th century Ernst Haeckel proposed that “ontogeny recapitulates phylogeny”: During an animal’s embryonic development it passed through the bodily forms of its ancestors. For example, the embryos of birds and mammals had gill-slits like those of fishes or tadpoles. This was actually an oversimplification and is no longer accepted. But Victorian biologists took it seriously in reconstructing the evolution of animals.

If recapitulation were true, it might be possible to recreate extinct species by delaying the maturation of the embryos of current species. Biologists were impressed by the axolotl, a salamander that retained its gills as an adult, remaining aquatic throughout its life. Controlled atavism might be a source of superhuman powers, letting human beings have the strength of apes, the agility of monkeys, or the gills of fish.



## EUGENICS

One proposed cure for white racial senescence was eugenics, or the systematic breeding of human beings for desirable traits. In the early 20th century this led to the sterilization of "mental defectives," which the U.S. Supreme Court ruled constitutional in Oliver Wendell Holmes' famous line "three generations of imbeciles is enough." Positive eugenics, or the encouragement of childbearing by desirable people and well-matched couples, never found official support – but many writers looked forward to a future when it would.

The following rules, adapted from *GURPS Bio-Tech* (pp. BIO28-29), can be used to develop a steampunk future where governments or other organizations engage in positive eugenics.

For each generation of controlled breeding, apply 1d-4 (at TL5) or 1d-3 (at TL(5+1)) character points toward producing genetic change. Positive points accumulate toward advantages or higher attributes; negative points toward disadvantages or lower attributes. Over 10 generations, on the average, a breeding program will accumulate 5 positive and 10 negative points at TL5; at TL(5+1) these are reversed. Normally the negative points will produce undesirable traits; on the other hand, imagine a breed of human beings with Dwarfism [-15], Attractiveness [5], and Manual Dexterity +1 [3] serving as entertainers for kings and millionaires in a very hierarchical society.

Eugenic principles can provide a scientific justification for the Genteel Proficiency delusion (see p. 45): one need only observe that the British aristocracy has been breeding itself for "character" for a long time.

## HUMANITY TRANSFORMED

The first experiments with synthetic drugs led to speculations about methods faster than eugenics for changing human nature. Often such changes were envisioned as movement along the evolutionary path: backward to an unintelligent brute or forward to transcendent intellectual and psychic gifts. Other transformations could be physical: Wells offers such examples as increased bodily growth and invisibility.

## GROWTH STIMULANTS

Growth stimulant compounds need to be given during a phase of the life cycle when the organism is naturally growing. In a realistic treatment, the result will be Gigantism; -1 HT is also common, as the organism's body is above its optimal size. In a cinematic campaign, the result may be enlarged human beings or other lifeforms. Templates for enlarged human beings are as follows:

*Continued on next page . . .*

## Magnetism

*varies*

A character with this advantage has an exceptional measure of whatever mysterious psychic force is involved in hypnotism and psychic phenomena. This confers +1 Charisma per level; in fact, Magnetism replaces the standard Charisma advantage if it is used. It also functions as an effective level of power for one or more of the psychic powers available in the period. Finally, Magnetism acts as a bonus to Hypnotism.

If the GM adopts this rule, Hypnotism is possible without physical communication, at -5 to skill. An initial session face to face is needed to establish sufficient psychic rapport for later sessions at a distance.

The cost of Magnetism is 10 points/level for a version granting a single psychic power, +5 points/level for each added power.

## GHOSTS

A number of 19th- and early 20th-century writers (among them Thomas Hardy, Algernon Charles Swinburne, A. E. Housman, and James Elroy Flecker) described death as final rest, with no anticipated resurrection. How they felt about this idea varied; Swinburne gave thanks "That dead men rise up never," Flecker thought it horrible. But the basic idea was new, or at least the freedom to express such unbelief was new. The question of whether any future life awaits the dead fascinated and troubled many Victorians and Edwardians.

One expression of this concern was the growth of the Spiritualist movement. Starting in 1848 when Margaret and Kate Fox of Hydesville, New York, reported receiving messages from a spirit haunting their cottage, this movement gained many adherents throughout the English-speaking world. The seance became a familiar ritual in the last half of the 19th century. Notable figures such as the British writer Arthur Conan Doyle and the American psychologist William James became involved in psychical research, trying to judge the truthfulness of spiritualist beliefs. Ghosts and spirits remained mysterious and terrifying, but they also offered comforting reassurance that there really might be a part of man that outlived bodily death.

If Victorian psychical researchers were correct, ghosts were a psychic phenomenon, a psychic residue of the living after their deaths. In fact, ghosts are merely the minority of spirits of the dead who have enough psychic strength to interact with the material world. The Ghost Form rules from pp. UN51-54 can be used for such restless spirits. For the general run of spirits of the dead, modify Ghost Form as follows: no materialization (-25%), no telepathic communication (-10%), no tapping fatigue (-10%), no poltergeist effects (-20%), no possession (-20%), no probability alteration (-20%). These changes reduce the cost of Spirit Form to 25 points.

## Ectoplasm

Victorian spiritualists often spoke of ectoplasm, a tenuous substance of which a ghostly manifestation could be formed. Ectoplasm allows the ghost to touch the living and to have a sense of touch, but not to lift anything substantial or inflict damage. If a ghost's materialization ability is limited to forming ectoplasm, treat this as a -5% limitation on the cost of Ghost Form.

## Mediums

Certain psychically gifted people may have the ability to act as mediums, perceiving and talking with the dead. A typical Victorian medium must be in

a trance state to perform this function. Treat this as the Preparation Required (1 hour, -50%) limitation (see p. CI111), reducing the cost of Medium (see p. CI41) to 5 points in this milieu. Very gifted mediums also have the Autotrance ability (5 points), for a total cost of 10 points.

If the medium can confer certain ghostly abilities on spirits that normally lack them, treat this as an enhancement to these abilities: +5% to let a spirit speak or form a visible image; +10% if the visible image is made of ectoplasm rather than purely phantasmal; +10% to let a spirit tap fatigue from assembled family members or communicate telepathically; +20% to let the spirit engage in poltergeists, possess the living, or alter probability.

The Channelling advantage (p. CI34) can be bought with the same restriction as the Medium advantage.

### Astral Travel

If ghosts and spirits are psychic entities, then the realm where they exist is probably the astral plane. (See also pp. UN104-105 and P51-53.) This implies that anyone with the skill of Astral Projection is visiting the realm of the dead and is likely to see some of them. In effect, an astral traveler is a spirit – temporarily, rather than permanently, separated from its body. However, astral travelers have only the abilities of the 25-point version of Spirit Form; additional ghostly abilities must be learned as the nearest equivalent psychic skills.

Three additional variants on these rules may be adopted at the GM's discretion. First, all psychic powers may actually involve astral projection; psychic skill rolls will then be at -1 if you retain a faint link with your body that lets you whisper a few words, -3 if you can move about in a somewhat dazed state, -5 if you are capable of normal physical actions. Second, the astral plane may also be the realm of dreams in general; if so, the skill of Lucid Dreaming allows astral travel. Finally, an astral traveler may gain the ability to materialize a physical body in a place he is astrally visiting; this is effectively the skill Autoteleport, as the old body will dematerialize in the process.

## ETHERIC DEVICES AND THE SPIRIT WORLD

Spirits normally have far too little energy to manifest themselves in the material world in any direct way. But they might be able to affect matter of very low density, such as rarefied gases, especially if they were electrically charged and thus subject to etheric influences.

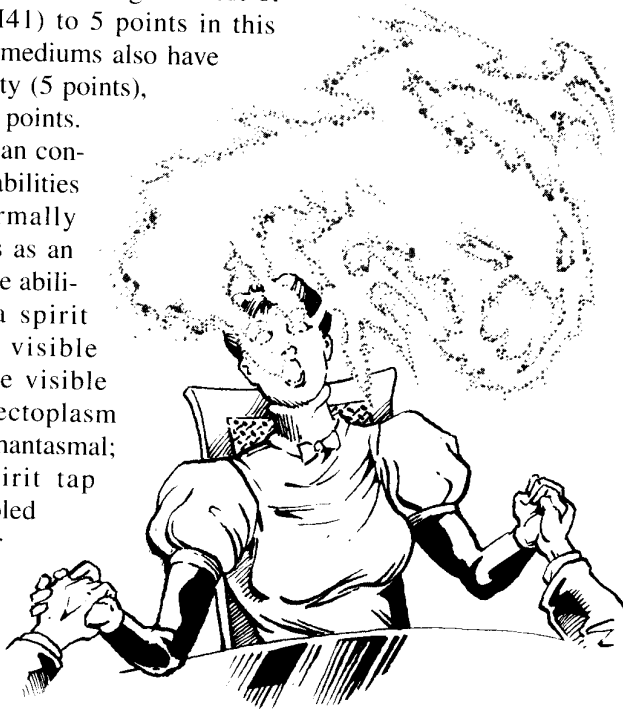

## HUMANITY TRANSFORMED (Continued)

### Enlarged Human Beings

Height	Area	Weight	ST/HP	IQ
×1.5	×2.5	×4	+5	+0
×2	×4	×8	+10	+1
×2.5	×6	×16	+15	+2
×3	×9	×27	+20	+3
×4	×16	×64	+30	+4

An enlarged human being has Inconvenient Size (-10) and levels of Increased Life Support based on increased food consumption (-10/level). This can be quantified as follows:

### Increased Life Support

Height	Meals/Dav	Size
×1.5	3	×1.5
×2	2	×3
×2.5	2	×3.75
×3	1	×9
×4	1/2	×24

(The last row indicates one meal every other day equal to 24 normal-sized meals – i.e., the equivalent of 12 normal-sized meals per day.)

### TISSUE BLEACHING

Tissue bleaching is a cinematic process that results in permanent invisibility to normal vision (see p. CI59). A realistic treatment would consider how the invisible man sees if his retinas are transparent, whether the process affects his skeleton, whether food and wastes are visible within his body, and the different refractive indices of air and transparent ectoplasm. In a cinematic campaign, a subject goes through 12 hours of discomfort and comes out with transparent flesh. The treatment is a 50-point invention and requires a Biochemistry or Pharmacy roll at -5. Failure reduces HT by the number of points of failure, followed by the normal process of recovery from disease (p. B133); after critical failure a natural 3 or 4 is needed to regain HT. The necessary chemicals cost \$50 per pound of body weight.



## PREDICTIVE SOCIAL SCIENCE

The systematic collection of economic, political, and social statistics began in the 19th century: this was another field in which Charles Babbage was a pioneer. Early social theorists hoped that their information would enable them to predict social developments – to identify the “laws of motion” that would make society as predictable as Newton’s laws made the orbits of the planets. Karl Marx’s claim, in *Capital*, to have proven scientifically that a socialist revolution was inevitable was only the most ambitious version of this idea.

Twentieth-century theorists tend to deny that predictive social science is even possible. But what if the 19th century’s hopes had been realized, with the help of social statistics and mechanical computers?

On the small scale, an organization that could predict social trends could take advantage of them, even if it lacked the power to change them. Consider the rewards available to a business from knowing whether a new product would sell, or what price it would sell for. Insurance companies are a real-life example of this: by knowing that people at a certain age have a certain life expectancy, they can sell life insurance policies at rates that will cover payments to the heirs and leave a margin of profit.

An organization that makes effective use of such information will not remain small. Ultimately, it will gain enough resources to change social trends – to go from social forecasting to social engineering. Its business practices, its funding, and its publicity campaigns will change people’s lives; even governments may have to listen to it.

For gaming purposes, the interesting phase in such an organization’s life may be before it has that level of control – when it has to contend with human wildness or even with rivals. The *Informationale* (pp. Y39-40) illustrates what can be done with such an organization and how ambiguously it can be presented.

Economics, History, Politics, and Strategy can all have required predictive specializations; all are Mental/Hard and have Mathematics as a prerequisite. The calculations usually require a large analytical engine (or equivalent dedicated system) and have a modifier equal to (Complexity - 4). Calculations performed with a slide rule are at -5; calculations performed by hand are at -6. Success results in advance information about some development, with a margin of error: critical success gives an exact prediction. An organization can use such advance information to gain an advantageous position – for example, an investment firm can choose good stocks to buy.

*Continued on next page . . .*

## Spectral Globe

The spectral globe could be developed through experiments with the electrical conductivity of gases. The globe would be evacuated and then filled with a gas, typically one of the noble gases, at very low pressure. Electrodes within the globe would then ionize the gas. If a spirit placed part of its immaterial form within the globe, its image would appear within the gas. The results would offer scientific proof of an afterlife. If an experimenter hit on the idea of hiring a lip reader, actual communication between the living and the dead could be established. A typical spectral globe might have volume 1 cf and weight 5 lbs., with supporting apparatus having volume 1 cf and weight 50 lbs.; total power consumption might be 1 kW and total price is \$25 (£5).

If spirits did not simply influence the spectral globes through some psychic power, but were actually themselves etheric entities, then the growth of etheric technology might affect them profoundly. Wireless telephony might pick up their voices; Hertzian waves might irritate them, or even – at the energy densities of beamed power – injure them. An etheric shock weapon would literally tear them to pieces. In fact, the use of such weapons on the battlefield might not just kill the enemy but annihilate their spirits. Given this assumption, allow any etheric weapon to inflict the same damage on a ghost or spirit as on a mortal human being. Such a discovery might actually make the etheric shock cannon a weapon too horrifying to be used. Simple possession of such a weapon could be treated as the most monstrous of crimes.

## PSYCHIC ARCHAEOLOGY

Several psychic powers can be applied to the discovery or investigation of archaeological sites, which is just beginning to be pursued systematically in the 19th century. Two such options are described here.

### *Finding the Ruins*

A dowsing technique, using a forked rod or a pendulum, can locate relics, ruins, or ancient city sites. This is an optional specialization of the Seekersense skill, giving +4 skill with proper equipment, but -2 without. It can be attempted once per day per site, either at the actual site or over a map. A critical success locates the site immediately, if it is within range (use the Telepathy ranges from p. P20); a success creates a “pull” in the right direction and allows a further roll every 10 minutes; a failure gives no result; a critical failure gives misleading information.

### *Reading the Ruins*

Psychometry gives a mental impression of an important event or period in an object’s history. Range is  $2'' \times \text{Power squared}$  for strong impressions, half that for weaker impressions; actual contact with an object (or standing on a site) gives +1 to skill. Each try takes one turn of concentration and a skill roll. Success gives a single emotional impression; success by 5+ or any critical success gives a detailed narrative.

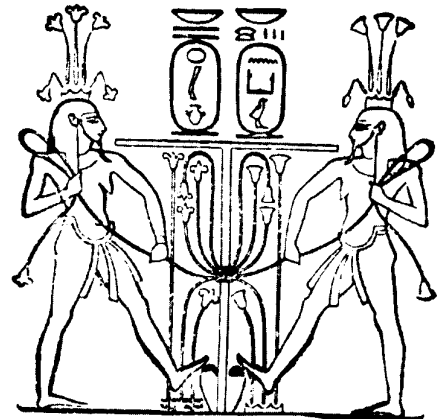

The length of time that can be scanned is a number of years equal to Power squared. Normally this will be the most recent years in an object's history. However, if an object has been buried or concealed, older impressions may be preserved, going backward from the time when it was last seen. Psychometrists thus strongly prefer to work on virgin sites; the excitement of one assistant who has just found a buried sword blade can destroy all traces of its past. (On a critical success, a psychometrist may still pick up a few residues of the older impressions.) A Will roll by an assistant who understands the need to discipline his thoughts can avoid this. Psychometry itself does not create new impressions; the psychometrist is in a passive, receptive state.

## MAGIC

As discussed in Chapter 1, steampunk campaigns do not have to include magic. But those that do can follow several different models, depending on what they are intended to simulate. All of these models use the standard GURPS magic system (pp. B146-164, M4-75, and all of *Grimoire*); a different variant of Victorian ritual magic could be based on *GURPS Voodoo*.

## FAIRY TALE MAGIC

The first model for steampunk magic is the treatment of magic in actual fantasy stories of the time, such as the stories of L. Frank Baum and E. Nesbitt.

Assume the world as a whole is low mana; a few locations are normal mana. Magery is either rare or non-existent among human beings. However, spirits such as djinn, hidden races such as fairies, or unique creatures such as the phoenix have Magery, sometimes at very high levels. Often they are also immortal and inhumanly beautiful as well as magical. Typically they should be built on 250 or 500 points and know dozens of spells. Or they may have specialized knacks instead.

Mortals gain access to magic through encountering a magical being or coming into possession of a magical treasure. It works according to rules that they can discover and work with. However, they will never really understand *how* it works, as opposed to what it does.

In this approach, magic is strictly under the control of the GM.

## VICTORIAN RITUAL MAGIC

The second model for steampunk magic is the practices of 19th- and early 20th-century ritual magicians, such as the Order of the Golden Dawn. This kind of magic takes a long time and uses arcane symbolism such as astrology or the Tarot that requires extended study. To represent this in game terms, use the following rules:

## WEIRD SCIENCE

## PREDICTIVE SOCIAL SCIENCE

(Continued)

If two organizations are attempting to gain positions of advantage in the same area, a Contest of Skills may be called for. The organization that makes a greater success is able to anticipate the actions of the other and allow for them in its plans. Even if it does not win the Contest of Skills, any success will make an organization aware of other organizations that have advance information, *if* the other organizations are taking action based on their predictions (choosing battle strategies, investments, or other positions). If they are simply observing they can remain invisible.

## PHRENOLOGY

Phrenology is now regarded as a mystical or occult theory, akin to palmistry. But it originated in serious scientific speculation: if the brain was the organ of consciousness, then the specialized functions of consciousness presumably were carried out by specialized brain centers, and the relative sizes of these brain centers could reveal the character of the person they belonged to. While brain functions are actually localized (as was demonstrated after the Russo-Japanese War, when high-speed bullets left survivors with parts of their brains missing), physical size is not a useful measure of their development. But if a GM creates a campaign world where Phrenology does work, careful collection of statistics might make it possible to diagnose character scientifically.

Treat Phrenology as a Professional Skill (M/A), in this case. Note that the GM doesn't have to reveal whether Phrenology really works in his campaign!

A successful Professional Skill (Phrenology) roll allows identification of a major psychological trait; this includes most mental advantages and disadvantages and IQ differences. The trait with the largest (positive or negative) point value will be identified; each additional point of success allows identification of one additional trait. A critical success will produce a complete diagnosis, including many quirks. (It could identify that someone is Proud, or that he is in love, but not with which specific person; it would not be needed to identify that he whistles between his teeth.)

Surgical alteration of personality by hammering down excessively large skull areas should only be effective in a silly campaign. Use Professional Skill (Phrenology) to decide which locations to modify; use Surgery to do the modification.



## TRANSCENDENTALISM

Transcendentalism was a philosophical movement derived from Immanuel Kant's attempt to explain why Newton's laws so perfectly described the physical world. Kant thought the human mind itself imposed patterns such as space and time, cause and effect, or action and reaction on the world; Newton's theories would always be true because they were hard-wired into people's minds, so it was impossible to observe anything that contradicted them.

But what things were like before human minds went to work on them was unknowable. Kant called this hidden realm the *noumenal* world and the world known to science the *phenomenal* world. Kant thought there was a transcendental ego that turned the unknowable noumena into phenomena, but that this ego itself was unknowable.

American philosophers such as Emerson and Thoreau, influenced by Kant's ideas and those of other German philosophers, and also by Christian mysticism and Hindu beliefs, tried to find ways to be aware of the noumenal world and the transcendental ego – not through the methods of science, but through meditation or the like. Ancient Hindu thinkers attributed amazing powers ("siddhis") to sages who had attained such insight; since they had seen behind the veil of illusion that was the world, they could reshape that illusion. For an esoteric or illuminated campaign, transcendentalism could offer superhuman abilities while still maintaining the truth (in a certain sense of "truth") of scientific theories. This is best used with the rules for psychic powers and explanations about "piercing the veil of mundane reality."

## Using Magic

As in the standard rules, magic uses fatigue. However, the fatigue is expended through prolonged labor and concentration, not in a rapid burst. Each hour spent in performing a ritual costs 1 fatigue; a spell takes as many hours as its fatigue cost, with a minimum of 1 hour. This can be modified by the Magery advantage: each level of Magery increases the amount of fatigue the mage can expend per hour by 1, with a proportionate reduction in the minimum time to complete a spell. Thus, a wizard with Magery-3 could cast a low-cost spell in 15 minutes. He would still not be able to cast more magic in a day than he had fatigue.

In effect, this approach makes *all* magic ceremonial magic (pp. M13-14). Cooperative spell casting is also allowed in Victorian ritual magic, with help from other mages, unskilled observers, or both. However, no matter how many different people are helping, time to cast cannot be reduced to less than 1 hour, unless all participants have one or more levels of Magery; faster casting simply doesn't allow sufficient depth of concentration for the helpers to do any good.

## INDUSTRIAL MAGIC

The third model for steampunk magic is intended for use in campaigns where magic, rather than engineering, is the basis for an industrial revolution. The appropriate rules are adapted from *GURPS Technomancer* (pp. T40-42).

A magical production line has two attributes: the number of enchanters who can work on it simultaneously and the specific function it is intended to perform (placing a given set of enchantments on a give physical object). Determine the energy cost of all the enchantments combined. The energy cost to enchant the production line equals 10 times this energy cost, multiplied by the square root of the number of enchanters who can work on the line, which must be at least four and no more than 400. The slow and sure method is used to enchant the production line (that is, one wizard-day per point of energy cost). How much this costs depends on how much enchanters earn per day; £1 per point of energy is reasonable in most worlds where magic is reasonably common, as it must be to have enough wizards to run a production line. The production line takes up one hex of floor space per mage working on it.

Industrial enchantment of an item has the normal energy cost, but requires one day per 5 energy points, divided by the number of enchanters working on the line. Monetary cost equals the cost of hiring the mages to work on the line (\$1 per point of energy is reasonable), multiplied by 2 to allow for overhead costs, plus the cost of any materials used to make the enchanted object.

The Power of a production line equals the skill of the lead enchanter who created it (in the lower of Enchant or whatever spell the production line is intended to perform). The Power of the items created equals the Power of the production line. All enchanters working on the line are considered to be acting as assistants.

# CHAPTER 7

# THE GRAND TOUR

*"... Do you know how long it would take an express train to reach the moon? Three hundred days. No more! A distance of 86,410 leagues, but what is that? That is only nine times around the earth, and any sailor or traveler expects to do more than that in his lifetime."*

*— Jules Verne, From the Earth to the Moon*



## AS POWERFUL AS A LOCOMOTIVE

To avoid the complex calculations of *GURPS Vehicles*, a locomotive can be treated as if it were a draft animal. The heaviest load a locomotive can pull is determined by its weight; under a heavier load it just spins its wheels. To determine its ST, multiply its weight in tons by 18. Then use the rules in *Lifting and Moving Things* (pp. B89-90), but divide effective weight by 200 for pulling cars on a railroad track.

Take the top speed for the locomotive and its coal car as its baseline speed. This is reduced as its tractive load increases:

Tractive load	Speed divisor
ST multiple	
None	1
Light	2
Medium	3
Heavy	4
Extra-heavy	5

Freight cars typically weigh 50 tons fully loaded; cars full of metal or minerals weigh 75 tons; cars full of clothing, furniture, or other light products weigh 25 tons. Passenger cars typically weigh between 15 and 25 tons. This can be used to estimate how many cars a locomotive can pull at various speeds. A dozen cars are a reasonably typical load.

For example, the locomotive in Chapter 5 (p. 74), weighing 27 tons, has ST 486. Its baseline speed is 70 mph. If it is pulling a dozen typical passenger cars, with total weight 240 tons, their effective weight is 2,400 lbs., which is just under 5 times its ST. This is a light load, allowing speed 35 mph. If it is pulling a dozen cars filled with pig iron, with total weight 900 tons, their effective weight is 9,000 pounds, slightly less than 19 times its ST; this is an extra-heavy load, allowing speed 14 mph. Other loads can be calculated similarly.

## CIRCUMNAVIGATION

The exact distance between two ports can be checked with atlases or other reference works. But for a quick estimate, here are some approximate distances:

London-New York	3,000 miles
New York-San Francisco	15,000 miles
San Francisco-Hong Kong	7,000 miles
Hong Kong-Singapore	3,000 miles
Singapore-Bombay	2,500 miles
Bombay-Suez	3,000 miles
Suez-London	3,000 miles

A total distance of 36,500 miles circles the globe by sea, costing roughly \$2,400 (\$200 per 3,000 miles). From New York to San Francisco by rail is roughly 3,000 miles and costs less than \$100, cutting total costs to roughly \$1,500.

# TRAVEL AND ITS DIFFICULTIES

Travel in the 19th century falls into three main categories: mechanized travel by airship, steamship, or railroad, local travel in civilized countries with good roads, and local or long-range travel in uncivilized lands.

Railroads covered England, the eastern United States, and parts of Europe by 1860. By 1900 they extended across North America, over all of Europe and into Russia, and over India. The first Orient Express from Paris to Istanbul ran in 1883. Freight trains average 20 mph, and passenger trains 40 mph; Britain's fastest train, the Flying Scotsman, makes the Edinburgh-London run at 55 mph. At these speeds a typical locomotive can pull a dozen cars. Fares go as low as 1d./mile (\$0.02/mile) on parliamentary trains (established by an 1844 act of Parliament); first class fares run about three times higher.

Steamships similarly speed up ocean travel. A steamer from New York to London needs two weeks for the crossing (a day or two more westbound, against the current, than eastbound). Sailing ships needed three weeks (and an extra week westbound). Travel to countries on the Indian and Pacific Oceans took substantially longer, requiring circumnavigation of Africa or South America, until the construction of the Suez and Panama canals – the first built from 1859-1869, the second from 1904-1914. The Panama Canal cuts 2,000 miles off a voyage from Britain to Australia and 8,000 miles off a voyage from New York to San Francisco. Travel by steamship is costly; in 1840 the transatlantic voyage costs \$200 per person.

Once a long-distance journey ends, the traveler needs to get about the city or countryside. The traditional methods are walking, riding a horse, or driving a carriage. Public transportation is available, in the form of a variety of cabs; London cab fare is 1s. (\$0.25) for 2 miles. Starting in 1828, cheaper transportation is provided by omnibuses (from the Latin *omnibus*, "for everyone") – large horse-drawn vehicles carrying a dozen or two passengers on a fixed route. By 1850, London has 1,500 of them, including some owned by hotels for the convenience of their guests.

The first great innovation in urban transportation is the bicycle. Bicyclists travel three times as fast as pedestrians: 150 miles in a day under ideal conditions with no encumbrance (see p. B187). Like other wheeled vehicles, bicycles perform best on roads. Even so, they find military applications, from laying telegraph wire to bicycle cavalry operations.

At roughly the same time, electric streetcars come into operation, starting in 1883 in Richmond, Virginia. They develop rapidly in the United States. Averaging 10 mph, they allow business and professional men to live in suburbs, leaving the central cities to immigrants and the poor. Streetcars are much cheaper than railroads – the motors are in the streetcar rather than a locomotive, the car is light and runs on less expensive rail, and there is no need for a stoker. Interurban rail systems grow up in the northeast, central Texas, and southern California; it is possible to travel from New York to Chicago in less than 48 hours.

Central Asia, the Canadian Arctic, and the interiors of Africa, South America, and New Guinea are limited to primitive transportation. Use the standard terrain and travel rules (pp. B187-188). Roads are never better than bad, and many areas have no roads at all. Coping with bad terrain and bad weather is part of what makes explorers heroic; a long journey overland, especially under time pressure, can be an appropriate dramatic episode.

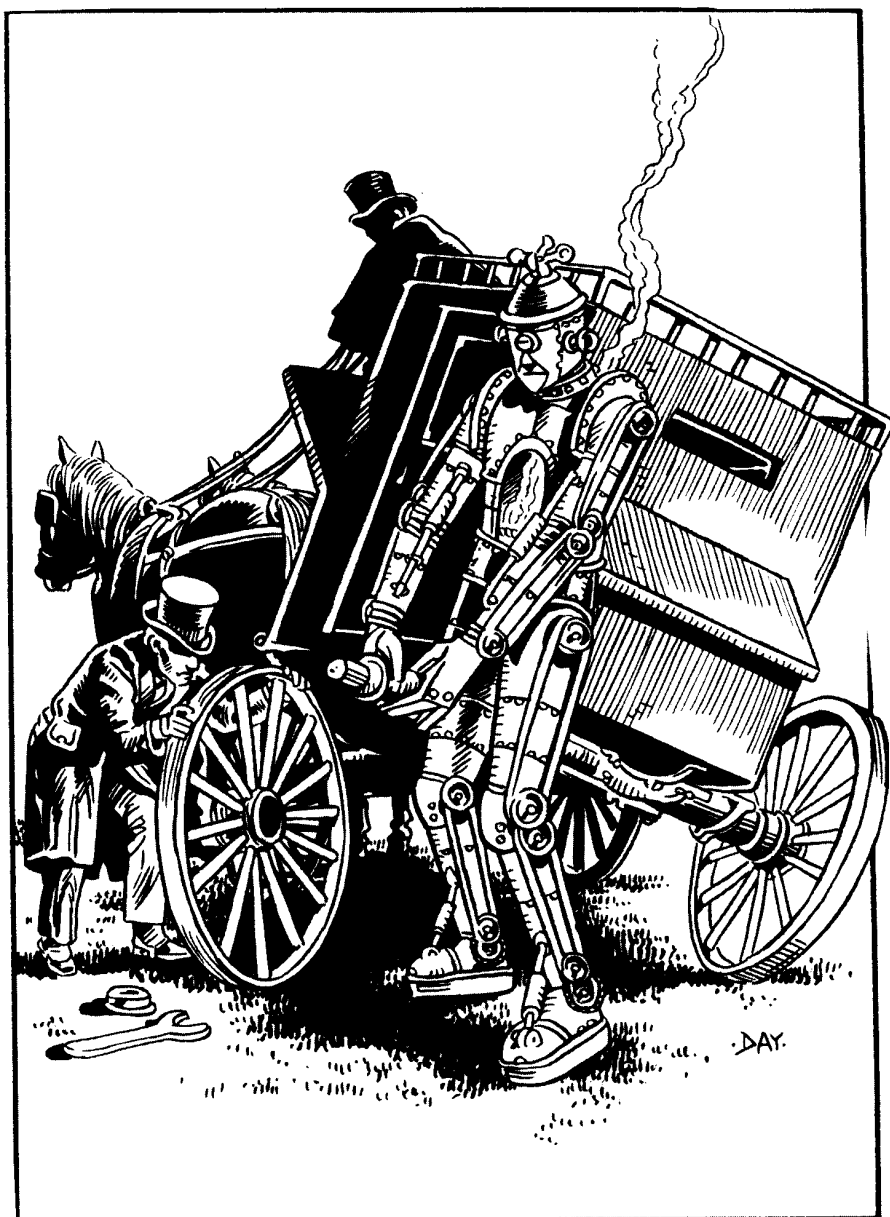

## THE BRITISH EMPIRE

The heart of the British Empire is the British Isles. Four major regions share a common ruler: England, Ireland, Scotland, and Wales. The majority of the population is in England and is of Germanic ancestry; the other three make up "the Celtic fringe," but have little else in common besides ancestry. Scotland is poor at the beginning of the century, but has a high level of education that enables it to develop a skilled workforce and technologically advanced industries, especially the shipyards of the Clyde River. Wales is actually the first region in Britain – or anywhere – to have nonfarmers outnumber farmers, but most of them are coal miners; few Welshmen become rich. The Irish are bitterly poor, and most are tenants of English and Scottish landlords; 1 million die and 1.5 million emigrate during the famine of 1845-1855, caused by potato blight. England's main urban centers are London (see below) and the new industrial cities of the north; Birmingham, Leeds, and Manchester all have over 1 million inhabitants by 1870.

## THE GRAND TOUR

### A MAN, A PLAN, A CANAL – PANAMA!

The Panama Canal, finished by the United States between 1904 and 1914 after a French effort in the 1880s failed disastrously, illustrates the dimensions of heroic engineering projects. The French excavated 30,000,000 cy at a cost of \$285 million and roughly 25,000 deaths. The Americans, with improved machinery and improved public health measures, excavated 232,000,000 cy at a cost of \$300 million and 5,600 deaths; they also paid the French \$40 million and Panama \$10 million. Total cost came to \$585 million and 30,000 deaths for 262,000,000 cy. Based on this example, it takes four levels of Multimillionaire for an individual to afford engineering on the heroic scale. Lesser projects such as large bridges and dams need one level less. Engineers' visions, such as damming the Mediterranean, need at least five levels of Multimillionaire.

### FREE TRADE

During the first part of the 19th century, Britain imposes high tariffs on imported grain, under the Corn Laws. These are unpopular with reformers and the poor, as they keep the price of basic foodstuffs high, and eventually the Anti-Corn-Law League secures their repeal. For the rest of the century any goods can be imported into Britain legally without tariffs. British food production decreases rapidly; by the end of the century over 50% of the grain consumed in Britain is imported, and an even larger share of meat, eggs, and cheese. If cut off from shipping, Britain faces starvation, which makes British control of the seas indispensable.

Other nations are less committed to free trade; only Britain abolishes tariffs outright. American tariffs are 49.5% up to 1890, 39.9% until 1894, 57% until 1897, 38% until 1909, and then 30% until the start of the Great War. European tariffs range from 4% in the Netherlands to 41% in Spain. However, free trade remains an important goal of 19th-century liberalism. Optimistic liberals point out that in a world of free trade, nations would be too economically interdependent to survive being cut off from trade by a war, making free trade a force for peace.

*Continued on next page . . .*







## FREE TRADE

(Continued)

Most 19th-century European countries do not require travelers to have passports. There are few barriers to international migration: millions leave Europe for the United States, seeking wealth or fleeing religious persecution or conscription. The first proposals to restrict immigration into the United States are aimed against the Chinese, whom labor unions see as potential strikebreakers. After 1900, such restrictions become more common, directed against "inferior racial stock" generally – meaning not only Africans and Asians, but southern and eastern Europeans and Jews.

## COLONIALISM AND ITS DISCONTENTS

How much do the European nations benefit from colonialism?

In the early 19th century, colonies are acquired for a variety of practical reasons. Some, such as India and the coast of West Africa, offer profitable trade; European powers want to provide safe marketplaces, to prevent local rulers from forcing unfavorable terms on merchants or prohibiting trade entirely, or to impose favorable terms for themselves, even monopolizing certain types of trade. Other colonies appeal to settlers looking for land; others provide dumping grounds for criminals or dissidents. Small colonies such as Gibraltar and Malta provide naval bases, which become even more important once steamships make coaling stations necessary.

In the final quarter of the 19th century, European powers seek colonies for other reasons: national power or prestige, or simply to keep them out of the hands of other powers. Africa is the great focus of this sort of colonization, as Britain, France, and even Portugal try to gain possession of vast connected domains of African territory. Colonies of this sort are difficult to administer, let alone modernize or make profitable, despite the efforts of European governments.

In some cases, the permanent administrative staffs of various governments recommend against acquiring colonies, only to be overruled in response to political pressure from various sources, from missionaries to businessmen. A wealthy man can influence public opinion: Cecil Rhodes is a leading advocate of the Boer War and William Randolph Hearst a major supporter of the Spanish-American War. More idealistic motives can also lead to intervention, as when Quakers and Dissenters lead the movement to end the slave trade and abolish slavery.

The Anglican Church is established in England and the Presbyterian Church in Scotland. Anglicans are divided into "high church," who favor elaborate rites approaching those of Roman Catholicism, and "low church," typically poorer and emphasizing moral instruction over ritual. Other Protestant churches are known as Dissenters; the Methodists are the most widespread, especially in the north of England and in Wales. The Irish are nearly all Roman Catholic, though the region around Belfast has many Protestants whose ancestors emigrated from Scotland.

Compared to other countries, Britain is fabulously wealthy. Its industrial growth is helped by having deposits of coal and iron close together and by the low cost of shipping along its coasts. British fleets circle the globe, bringing food and raw materials and taking back manufactured goods. British capital funds most of the world's economic growth, especially in the United States, Canada, Australia, South Africa, India, and Argentina – and earns interest. The only international capital flow of comparable size is from France (and later Germany) to Russia. The British navy safeguards trade and enables Britain to pressure other governments into safeguarding British investments.

Britain's largest overseas possession is Canada, which extends across North America from the Atlantic to the Pacific, though nearly all its inhabitants live within 100 miles of the southern border. The economy is based on agriculture, forestry, fishing, trapping, and mining. The British North America Act of 1867 creates the Dominion of Canada with its own parliament. Quebec is mainly French-speaking and Roman Catholic; the other provinces are mainly English-speaking and Protestant. The new government promptly negotiates to buy out the territory claimed by the Hudson's Bay Company for \$15,000,000. Under the leadership of Louis Riel, armed rebellions take place in 1870 and 1885, leading to the creation of Manitoba (1870), the admission of British Columbia (1871), and the building of a transcontinental railroad (completed in 1885). Newfoundland is a separate colony, supported almost entirely by fishing.

Australia, like Canada, has a large land area and a small population, most of whom live in the coastal regions of the south. Politically it is made up of several separate colonies until 1901, when the Commonwealth of Australia is established. The economy is largely supported by sheep grazing and other agriculture and by mining. New Zealand is made part of the British Empire by the Treaty of Waitangi in 1840, with a parliament established in 1853, and becomes a Dominion in 1907. Disputes between settlers and the native Maori population provoke a series of wars continuing until 1870. Sheep grazing dominates the economy even more than that of Australia.

South Africa became a British possession during the Napoleonic Wars. The British face bitter opposition from the Zulus, leading to the Zulu War of 1879; Zululand becomes a British protectorate in 1887 and is merged with Natal in 1897. Economic development begins with the discovery of diamonds in 1868 and accelerates in 1886 when gold is found in the Witwatersrand, attracting increased British settlement. Cecil Rhodes gains control of both industries, creating the diamond consortium of De Beers. In 1910 the Union of South Africa becomes a British dominion with a white-controlled government.

Britain's most populous possession and the source of much of its wealth is India (see *Asiatic Kingdoms*). Annual revenue is \$20,000,000, from the opium trade and from taxes on agriculture and salt. British soldiers and civil servants and their dependents form an isolated community that adheres to British customs as devotedly as any Hindu caste adheres to its own standards of purity, creating their own special version of Englishness.

Britain holds other colonies throughout the world; it is said that "The sun never sets on the British Empire." Many are small territories in strategic locations, such as Gibraltar at the entrance to the Mediterranean and Singapore at the tip of the Malay Peninsula. Often they are brought into the empire by private adventurers such as Stamford Raffles (the founder of Singapore), James Brooke ("the white rajah of Sarawak"), and Cecil Rhodes.

Wherever they go, the British export their characteristic institutions and customs. The English language, the Anglican Church, the common law, parliamentary government, and the monarchy unite British colonists around the world; Hindus and Muslims in India and former slaves in Jamaica use the English language to petition for their rights as British subjects. British customs ranging from cricket matches to afternoon tea are adopted as well.

The British are great railroad builders; nearly any country in the Empire will have modern transportation, at least between major cities.

## THE METROPOLIS

London in the 19th century is Europe's largest city. In 1871, it has 3.9 million inhabitants, more than twice as many as Paris, Europe's next largest city. From the medieval city limits, a district still called The City, it sprawls both north and south of the River Thames. Despite being 50 miles upriver from the English Channel, London is a major port.

Politically, London is the capital of the United Kingdom and of the British Empire. Parliament meets there, and the royal family's main residence, Buckingham Palace, is within the city. London is the site of the Admiralty and the Horse Guards (occupied by the Commander in Chief of the army), as well as the major government offices – the Foreign Office, the War Office, the Home Office, the Colonial Office, and the India Office. The Metropolitan Police are headquartered there, first at Scotland Yard, founded in 1829, and then at New Scotland Yard, founded in 1890. Officially Scotland Yard is only responsible for the roughly 700 square miles of the metropolitan area (not including the City of London), but its officers act as consultants for cases throughout the country. This administrative complexity is typical of London; local government is divided into some 90 municipalities, each with its own policies.

London holds Britain's key economic institutions, making it the financial capital of the world. The Bank of England, the Royal Mint, the Stock Exchange, and Lloyd's are all located there. Much of Britain's industry is in Manchester, Liverpool, and Leeds, but the funding comes from London. Londoners manage Britain's extensive overseas investments as well.

With all this wealth, the city is the center of society and the arts. Most of England's aristocracy and gentry have houses there, where they spend the social season. Some 10,000 people make up fashionable society. They begin coming to London after Christmas. Following Parliament's Easter recess the real season begins and lasts until August 12, when Parliament adjourns for the grouse season, followed by partridge season on September 1, pheasant season on October 1, and fox hunting on the first Monday in November.

## THE IRISH QUESTION

One of Britain's most troublesome colonies is its closest. Conquered by invasions under a succession of British rulers, Ireland has never accepted its status, though it has neither the wealth nor the population to gain independence. Legally, Ireland is part of Britain, with parliamentary representation; but the reality is English and Scottish landlords getting rich while the Irish tenants starve. In the 18th century the Irish were a minority group in their own country; in the 19th century, after Catholic emancipation, they are second-class citizens.

Demands for independence are put forward by methods ranging from speeches in Parliament to bombings of government buildings. Many of the English cannot understand the motives for such actions; they take it for granted that the Irish owe loyalty to the Queen and consider the rebels to be criminals – in Kipling's words, "You're only traitors to the Queen and rebels to the Crown." Many of the Irish see it differently.

English characters involved in law enforcement or covert operations may have to contend with Irish rebels, and with the moral and political question of Irish independence.

## ABOLISHING SLAVERY

Between 1803 and 1818, the slave trade was banned by many European nations and by the United States. From 1825 on, the British navy attempts to enforce the ban by patrolling the West African coast, capturing 1,287 slavers between 1825 and 1865. However, smugglers carry on the trade, carrying even more captives to the Americas than when the slave trade was legal. The abolition of slavery in the United States in 1863 makes the slave trade unprofitable. Slavery remains legal in Brazil and Cuba into the 1880s, but very few new slaves are brought in from Africa.

While it lasts, slavery is associated with plantation agriculture and the regions that engage in it. Brazilian coffee, Caribbean sugar, and cotton and tobacco in the American South are produced on a scale that requires large work gangs. These regions have large populations of African descent, with African religious and cultural influences.

The French abolished slavery in Haiti in 1794, after a slave revolt, and made Toussaint-L'Ouverture governor general in 1801; Haiti became independent in 1804. At first the whole island was independent, but the British and Spanish reconquer the eastern half, which becomes Santo Domingo. This leaves Haiti as the second independent nation of the Americas. As a free black state, Haiti is feared and hated by slaveholding countries, but gains diplomatic recognition from the United States in 1862.

*Continued on next page . . .*

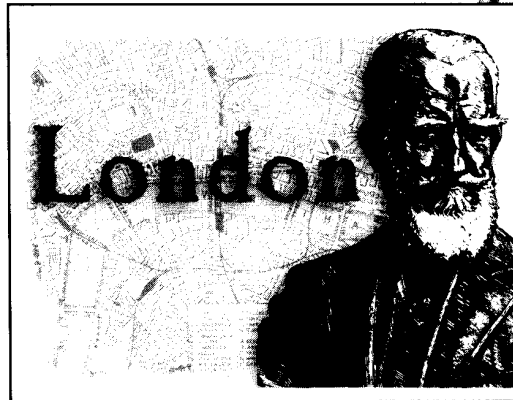

## ABOLISHING SLAVERY

(Continued)

The other great slaveholding region is the Middle East; more African slaves are sold there (14 million total) than in the Americas (11 million total). Britain pressures the Ottoman Empire into banning the slave trade in 1847, but it continues in other Muslim countries. Eunuchs bring high prices, but castration is forbidden under Muslim law, so it is performed in Africa, usually crudely, with 90% mortality. Many slaves are marched across the Sahara desert, often dying of exhaustion or thirst. Others are shipped to the Zanzibar slave market, which operates openly until 1873, when the British navy closes it. This branch of the slave trade continues into the 20th century, but no longer openly.

## LATIN AMERICA

The Spanish colonies of the mainland gain independence between 1810 and 1824, in a series of rebellions inspired by the American War of Independence. Simon Bolivar is regarded as the greatest leader of the rebellions; he sometimes serves as the president of two or three countries at the same time. However, he is unable to unify Latin America, which ends up with 18 Spanish-speaking countries, though two of them, Cuba and Santo Domingo, remain Spanish colonies until the Spanish-American War of 1898. Brazil becomes an empire in 1822 and remains so until 1889, when the reaction against Pedro II's abolition of slavery drives him into exile in Paris. The Latin American countries are politically unstable, with frequent revolutions and dictatorships and occasional wars, notably the War of the Pacific (1879-1884), when Chile takes possession of Bolivia's seacoast and nitrate deposits and successfully invades Peru, and the Paraguayan war against Argentina, Brazil, and Uruguay, in which 1,000,000 Paraguayans are killed.

*Continued on next page . . .*

Sporting events, balls and dances, and artistic events entertain the wealthy; theaters and music halls are available for all levels of society, as are pubs. Many private clubs offer a meeting place for gentlemen visiting London for a short stay. At other times of the year, visits to country houses are important, and the railroad makes it possible to spend a weekend in the country and come back to London during the week.

The wealthy live in the West End of London; the best area is around Hyde Park. The poor live in the East End. Southwark, across the Thames, was built up more recently. A network of underground railways links the city together, as do telegraph lines, six mail deliveries a day, and telephones after 1879. Smoke from the railroads and from coal fires threatens inhabitants' health, and smoke and London's famous fogs often cut visibility; sometimes people literally walk into the Thames (Vision modifiers -1 to -5). Gaslamps, set up in some areas by 1815, help a little, but until the 1880s only the main streets and wealthy areas have them. After that, London takes on the "gaslight" appearance familiar from Arthur Conan Doyle and other writers.



and its publishers bring out pirated editions of many books. American manners strike the British as crude. Before the American Civil War, the persistence of slavery in the United States is a focus of British criticism. At the

## OUR AMERICAN COUSINS

After 1815, there is never a serious threat of war between Britain and the United States; the Canadian border is established by peaceful negotiation. The two countries are linked by steamships and the first transatlantic cable. British investments finance American railroads and industrialization; in the last half century, the United States overtakes Britain in both population and economic productivity, and New York City becomes London's rival for the world's financial capital.

The two peoples have mixed feelings about each other. British writers who visit the United States are often harshly critical of Americans, not least because the United States does not recognize British copyrights

same time, the British, especially British liberals, often admire American energy and ambition and the American sense of equality. Americans regard the British aristocracy as old-fashioned, but wealthy Americans are eager to visit England and have no objection to their daughters marrying into the aristocracy. The American expatriate living in England is a familiar character in novels.

The huge scale of the United States makes efficient transportation vital. The American government supports the first transcontinental railroad with land grants and President Grant drives its final spike at Promontory, Utah on May 10, 1869. Chicago becomes a major city

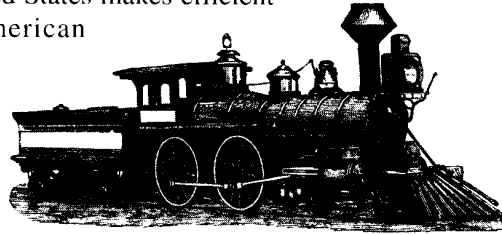

as the point where rail lines converge, bringing wheat and corn from the great plains, cotton from the south, and cattle and wool from the west for overseas shipment via the Great Lakes and the Erie Canal. Railroads are the first great American industrial firms and create many other industries; conflicts over shipping rates and wages make them one of the first industries regulated by the federal government. The faster development of railroads in the north is a major reason for the Union's victory over the Confederacy.

Americans are inventive and proud of it. Benjamin Franklin is a national hero; Thomas Edison becomes another in the 19th century, nicknamed "the wizard of Menlo Park." (A genre of popular fiction about heroic inventors traveling into outer space is named the *edisonade* in his honor.) There is less interest in theoretical science, though the country can claim a few great names. Land-grant colleges in many states emphasize agricultural and mechanical knowledge over pure science or the humanities. Through most of the 19th century the training of career army and navy officers at West Point and Annapolis is the most academically rigorous anywhere, emphasizing engineering and mathematics.

Like the British, Americans are commercially minded. If anything, their bankers, merchants, and industrialists play a larger role in national affairs, since there are no noble families. Powerful men often brag about starting their lives in poverty and working their way up, and a substantial number of wealthy Americans really did this. The South has more of an aristocratic tradition than the rest of the country, though the American Civil War impoverishes many plantation owners. A preference for land as the best form of wealth and for the military as the best career, a love of horses and weapons, and a code of personal honor that can lead to dueling are all common in old southern families.

The South also has most of America's black population, though at the end of the Age of Steam some of them are going north on the railroad to look for work. Every country has racial inequality, but few have as large a racial minority as the United States. Liberia is founded to provide an African homeland for American blacks, but only a minority want to leave the United States. After the Civil War and Reconstruction, the South keeps blacks subjugated, partly through discriminatory laws and partly through lynchings that, like duels, are tolerated by the legal authorities. The rest of the country considers lynchings shocking, but blacks don't have equal rights there either – nor do Native Americans, Chinese and Japanese immigrants, or Jews. Even so, the country is a virtual paradise in the eyes of most of the world.

## LATIN AMERICA

(Continued)

The Monroe Doctrine of 1823 declares the Americas off-limits to European colonization, making the United States of America the protector of Latin American independence. This is only violated once, in 1863-1867, when Napoleon III of France makes Maximilian of Austria the emperor of Mexico while the United States is preoccupied with the Civil War. The United States often presumes more on its self-proclaimed guardianship than Latin Americans consider acceptable, as when the U.S. Navy steps in in 1903 to preserve Panama's newly declared independence from Colombia, just as the United States is planning to take over the Panama Canal project. The Mexican dictator Porfirio Diaz says "Poor Mexico – So far from God and so close to the United States!"

Argentina and Chile are prosperous, with economies based respectively on cattle ranching and minerals. Their populations are predominantly white and growing more so with steady European immigration. Brazil is multiracial, with elaborate social distinctions based on exact skin shades, but is fairly well off thanks to its coffee plantations. Latin America's other large nation, Mexico, is slow to develop economically and suffers a major revolution in 1910-1917.

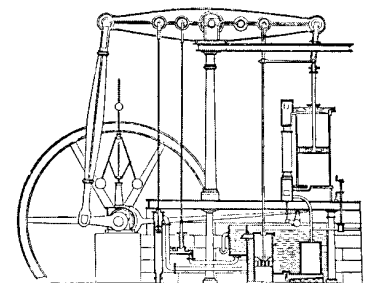

The culture of Latin America is based on European aristocratic traditions, with emphasis on personal dignity and honor. Ownership of land confers more status than any other form of wealth. Large cities aspire to European sophistication; half a dozen Latin American countries have opera houses.

Travel by railroad remains little developed; shipping routes along the coasts are the preferred form of travel. Eastern South America has large rivers, the Orinoco, the Amazon, and the La Plata, which offer access to the interior, but there is little settlement to attract travelers. Elsewhere transportation is over land, often through difficult terrain. Much of the interior remains poorly known into the 20th century.

# THE CONTINENT

## THE WILD WEST

The United States west of the Mississippi river is lightly settled in the 19th century. Three territories do not become states until the 20th century: Oklahoma in 1907 and New Mexico and Arizona in 1912. Native American tribes carry on an intermittent war against white seizure of their lands, but occasional bloody victories make no difference in the long run.

Before the extension of railroads across the continent, animal-based transportation systems on a heroic scale cross the American west: the Pony Express and stagecoach lines for rapid transportation, slow ox-drawn covered wagons for parties of settlers, and cattle drives destined for the stockyards of Chicago. The railroads offer fast, cheap transportation, but their lines are widely spaced; horsemanship remains a vital skill.

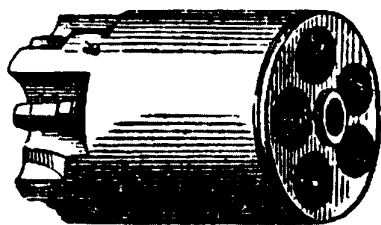

Another technological innovation becomes a central feature of the western legend: the Colt revolver. Its military applications are limited, but it quickly becomes the standard weapon for law enforcement and for anyone who needs a personal weapon. Men such as John Wesley Hardin (pp. WWii92-93), whose fast reflexes make them masters of this new form of dueling, become famous for their skills, and no story of western adventure is complete without a gunfight.

The major conflicts are over economic resources. Cattle ranchers, sheep ranchers, farmers, and miners have conflicting ideas of suitable land use and sometimes settle their disputes violently. Water is scarce and water rights become the subject of elaborate legal rules.

For a detailed treatment of the American West during this period, see *GURPS Old West*.

*Continued on next page . . .*

Before 1860, both Germany and Italy are divided into many small states. After 1870, both are unified nations, and Germany is a rapidly rising Great Power.

Until the end of the 19th century, Britain's greatest rival is France. The two nations are not outright enemies, but the French object to Britain's naval and colonial dominance and try to contest both. The first steam warship, for example, is the *Gloire*, built in France. France's population is larger, but its economy remains less industrialized and less urbanized, with only one city, Paris, that exceeds 1 million inhabitants. France is politically unstable, alternately a monarchy and a republic, as Bourbonists, Orleanists, Bonapartists, and Republicans contend not just over who shall be head of state but over what form the state should take.

Paris is the center of French life, politically, economically, and culturally. In fact, Paris outdoes London as a cultural center, especially in the visual arts; impressionism and other 19th-century artistic movements are born there. Wealthy British ladies travel to Paris to shop for dresses and hats and to hire French cooks and maids.

Paris is the first stop on the continental tour that is considered essential to finish off a gentleman's education. Other countries share this assumption; the Germans say, "As happy as God in France." The ability to speak French is widespread among the upper classes all over Europe.

Europe's third major power, Russia, is utterly different from both Britain and France, despite being allied with France at the end of the century. Its religion is neither Catholic nor Protestant but Eastern Orthodox, its government is an absolute monarchy, and its people are largely illiterate peasants. European influences are confined to comparatively small populations of aristocrats, the middle classes, and city dwellers; some nobles actually speak French more fluently than Russian. St. Petersburg, the national capital, is also Russia's most Westernized city, built by Peter the Great in 1703 on land captured from Sweden. Part of Westernization is the persistence of revolutionary ideologies and movements, despite the efforts of the secret police, who succeed only in driving them underground as conspirators. Russia's power comes from its huge size and from a population twice that of any other European country. The Russian Empire expands nearly as fast as the British, but entirely over land, reaching the Pacific Ocean (and North America, until the United States purchases Alaska in 1867) and grasping at Afghanistan and Persia.

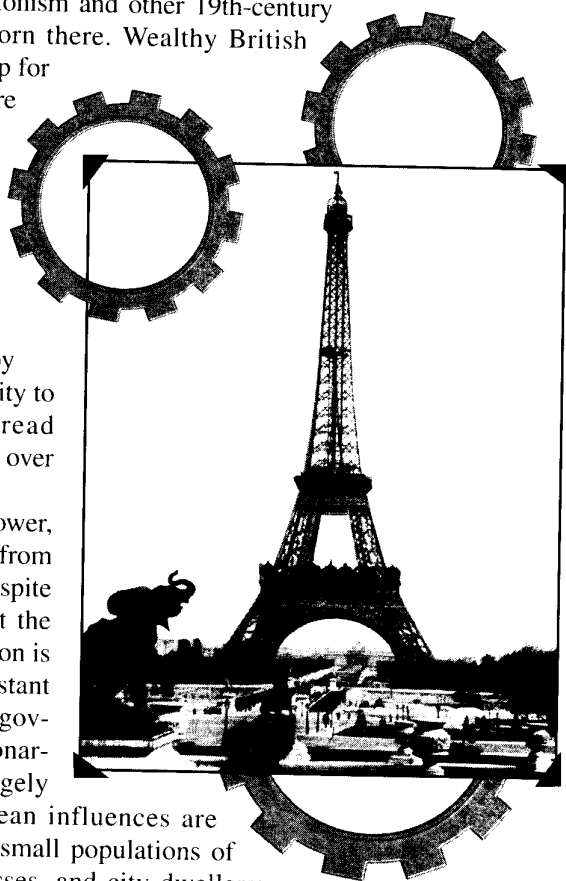

Prussia, before 1871, and a unified Germany, after 1871, are nearly as autocratic as Russia, but much more modern. The government actively supports science and industry, regarding them as tools of national policy and military strength. Germany creates the pattern for education, from kindergartens to universities that combine teaching and research. Serious scientists in every country learn German, and university graduates come to Germany to do advanced work. German science provides the basis for new industries, such as the chemical industry; over the course of the century the German economy overtakes the British. Bismarck's domestic policies, including the creation of the first social security system, reduce unrest among workers by making the state their benefactor.

One of the most visible features of German culture is strong awareness of social stratification, far stronger than Britain's. Nearly every aspect of life is governed by some system of ranks, and those systems nearly all translate into Social Status. By German standards, the most class-conscious Englishman is a bit anarchistic, and the most conscientious Englishman lacks a proper sense of duty.

Three other European nations are great powers in the second half of the century, at least by courtesy. Austria-Hungary shares a language with Germany, but is much less modern; its emperor's subjects include millions of Slavs in Bohemia and the Balkans, many as poor and ignorant as Russian serfs. But its capital, Vienna, is one of Europe's largest cities, as large as Berlin, and a center of culture and the arts, nearly as rich as Paris. The Ottoman Empire, "the sick man of Europe," loses nearly all of its European territory, but still dominates the Middle East, aided by Britain, which sees it as a counterweight to Russian expansionism. Italy is unified in 1861, except for the Papal States, which are taken over by force in 1870 while their French protectors are distracted by the Franco-Prussian War; it is a useful ally for Britain and a popular destination for travelers.

The Netherlands and Belgium, in northern Europe, and Spain and Portugal, in southern Europe, are secondary colonial powers (though Spain loses nearly all its colonies to the United States in 1898). Belgium industrializes early and for a time has the highest industrial productivity per capita on the continent. The Scandinavian countries have no colonies (other than Greenland, a Danish possession) but by the end of the century are highly modernized; in 1895 Stockholm has more telephones per capita than any other city on Earth, followed by Oslo. The Balkans are scarcely European at all (see sidebar, this page); in this period "the Near East" refers to Serbia, Bulgaria, and Roumania.

Outside the Balkans, Europe has modern transportation. Railroads penetrate into and eventually cross Asiatic Russia, but don't really conquer its huge distances.

## ASIATIC KINGDOMS

The religions, cultures, and languages of Asia are far more diverse than those of Europe, representing several unrelated traditions. But to Europeans in this period, they all seem more or less alike, sharing a common "Asiatic" quality that encompasses heathen religious beliefs, inefficient, corrupt, and despotic government, and economic and technological backwardness. The lucky ones get taken over by some European country and governed properly, though they seldom show much gratitude for the help.



## THE WILD WEST

(Continued)

### THE MORMONS

Joseph Smith founds the Church of Jesus Christ of Latter-Day Saints in 1827, and despite persecution for their practice of polygamy, they become a major new religious community. After Smith's murder in 1844, Brigham Young leads them on an epic journey to the shores of the Great Salt Lake. They become the state of Utah in 1896, after the church abandons polygamy in 1890.

A campaign set in the United States may encounter Smith or Mormonism in a variety of roles. Joseph Smith's movement is part of the century's resurgence of religious faith, though other churches do not consider it Christian. The hostility with which the Mormons are regarded is illustrated by their appearance in *A Study in Scarlet*, the first Sherlock Holmes novel, as a despotic theocracy with secret police agents who kidnap women to provide wives for the church's elders; treating Holmes' adventures as fact rather than fiction entails a grim view of the Mormon community. Smith was a practitioner of psychic archaeology (see p. 106), using a luminous stone to hunt for buried treasure. *The Book of Mormon*, the church's scripture, presents an account of North American prehistory as a war between the virtuous, white-skinned Nephites and the sinful, red-skinned Lamanites, who eventually exterminated them; Smith says that he translated the book from golden plates which he read with magic spectacles. The church sponsors archaeological projects based on its account of American prehistory; such an expedition might find a place of mystery or even a lost city (see sidebar, p. 122).

### THE BALKANS

This region is traditionally called "the powder keg of Europe," and with good reason. Southeastern Europe is a region of diverse nationalities, languages, and religions, divided by centuries-old conflicts, occupying mountainous terrain that offers refuge to patriots, revolutionaries, and outright bandits — three groups not always easy to distinguish!

*Continued on next page . . .*





## THE BALKANS

(Continued)

Most of the area is under the control of the Ottoman Empire in 1815. Over the century that follows, one nation after another breaks free, starting with Greece in 1832. Boundaries constantly shift: southern Bulgaria is briefly a separate independent nation, Rumelia, and several great powers bitterly oppose its union with Bulgaria; Austria acquires Bosnia and Herzegovina in 1878; Transylvania remains part of Hungary until after the Great War, during which Greece also takes possession of Bulgaria's Aegean seacoast. Russia, Austria-Hungary (encouraged by Germany), and the Ottoman Empire (propped up by Britain and France) meddle constantly.

Throughout the century, the Balkans are poor, backward, superstitious, violent, and filled with intrigue – obviously the perfect place to look for adventure in Europe. Travel there is moderately difficult, with limited and irregular train service and rugged terrain.

## VIRTUAL EUROPE

Europe has some of the world's smallest countries – Luxembourg, Andorra, San Marino, Liechtenstein, Monaco, and the Vatican City – and before German and Italian unification it has many more. These little kingdoms appeal to romantic storytellers, who often invent their own, such as Ruritania in *The Prisoner of Zenda*. Such countries offer settings for swashbuckling campaigns with steampunk technology.

In general, the best sites for virtual countries are Italy before 1861, Germany before 1871, or the Balkans through 1914; there are enough real small countries there to make it easy to suspend disbelief in one more. Another option is to set virtual countries on boundaries between major real countries. Imaginary islands are also worth consideration, so long as their presence would not have substantially changed the course of Atlantic exploration.

A different approach is to make virtual countries the product of an alternative history in which some real nationality kept or regained its independence, perhaps with steam technology or perhaps centuries earlier. The campaign could visit a free Catalonia or an independent Shetland.

What impact will virtual European countries have on history? Often very little: novelists tend to imagine them as archaic and picturesque, or as too small to be effective. But advanced technology and efficient organization can make a small nation disproportionately effective, as they did Portugal and later the Netherlands. With steam technology, a seemingly unpromising nation might emerge as a leading European power.

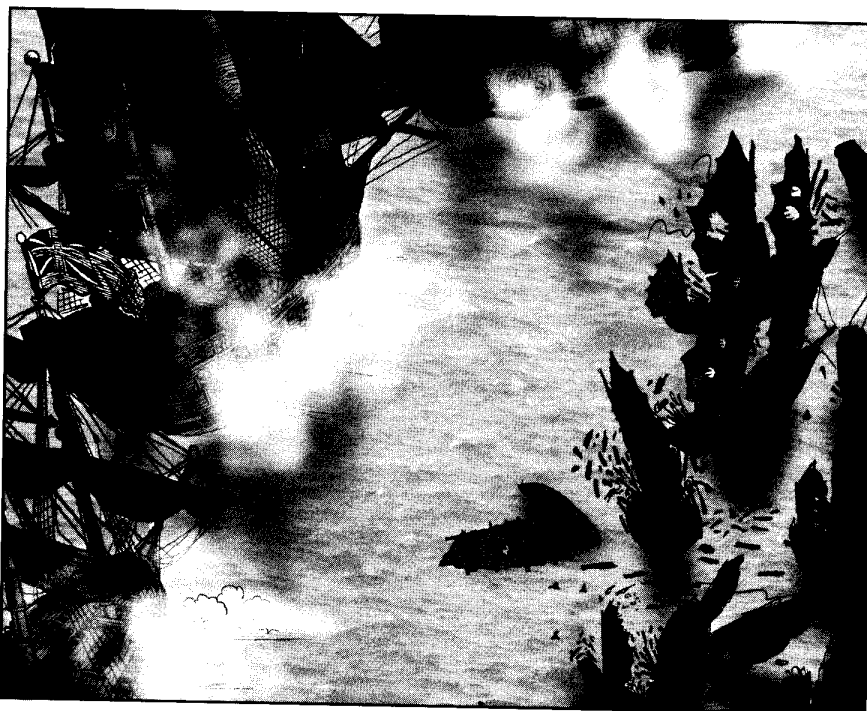

At the Western end of Asia is the Ottoman Empire, ruled by the Sultan in Constantinople. The empire is predominantly Muslim, though Jewish and Christian minorities are officially protected by law. In this period, the Ottoman Empire controls an Arabic-speaking region stretching from Palestine to the mouth of the Tigris and Euphrates and down both coasts of Arabia. Egypt is nominally part of the empire, but it is occupied by Britain in 1882. The Ottomans retain a belt of land in the Balkans stretching from Thrace across Macedonia to Albania until an uprising in 1912. Part of the region becomes independent Albania; the rest is annexed by existing Balkan states.

Persia is also Muslim, but adheres to a different form of the faith, called Shi'ite. Its government is weak; for the last half of the century it suffers regular meddling by Britain and Russia. Afghanistan, northeast of Persia, is in a similar position, but its people are so warlike that both the British and the Russians tend to regret interfering with its politics.

South Asia is almost entirely British, though the Portuguese hold small colonies at Goa, Diu, and Damão and the French have five even smaller colonies. Before the Sepoy Rebellion, India is governed by the British East India Company; afterward the British government takes control of India, which is placed under a viceroy. Burma is part of the package after 1886, despite being culturally utterly different from India. However, large areas of India – the “native states” – remain under the control of their own royal families, with British advisors. Britain stations 60,000 British soldiers in India and raises 130,000 native troops with British officers; these are sufficient to keep 1,000 times their number under control. Britain invests massively in India, especially in railroad construction.

France holds several colonies that make up French Indochina, which will one day become Cambodia and Vietnam. Between French Indochina and Burma is Siam, which maintains its independence partly by being a convenient buffer state. King Mongkut and his son King Chulalongkorn have treaties with both Britain and France; Chulalongkorn travels to Europe in 1895 and 1897 and visits many European courts. Even so, Siam loses Laos to the French in 1893, and it is incorporated into Indochina.

Further south are the Malay States, controlled by the British; Singapore, also controlled by the British and a major port; and the East Indies, predominantly Dutch, though several areas on Borneo are British. The Philippines, north of the Dutch East Indies, are a Spanish colony until 1898, when the United States takes over.

On the continent, north of Indochina, China is nominally an independent empire. However, it has little real power, a fact that is demonstrated humiliatingly in the Opium War (1839-1842), when the British navy forces the imperial government to allow the importation of opium from India. Later conflicts include the Taiping Rebellion (1850-1864) and the Boxer Rebellion (1900). The Chinese are the largest nation on Earth, but far from the most powerful; a conviction of their own cultural superiority over European barbarians makes them slow to modernize. In 1911, the Ching Dynasty is replaced by the Chinese Republic under Sun Yat-sen.

Many Chinese travel overseas, to destinations from Singapore to San Francisco and even London. They become a "middleman minority," as merchants and moneylenders, playing a role throughout southeast Asia similar to that of the Jews in medieval and Renaissance Europe. Poorer overseas Chinese serve as laborers, notably in the United States, where they are the target of white resentment, especially from labor unions.

Finally, there is the Japanese Empire, which not only retains its independence but makes itself a great power.

India, China, and Japan have railroads; the rest of Asia relies on older methods of travel.

## JAPAN

Japan may be the 19th century's most extraordinary success story. In 1815 it is an isolated, backward nation grudgingly tolerating a few Dutch traders. By 1914 Japan is a modern state with a powerful navy and a rapidly industrializing economy to support it. Europeans mostly fail to recognize this, seeing Japan as quaintly exotic and not understanding Japanese determination to learn from the West.

## ZIONISM

During the 19th century, as society becomes more secularized, a new conception of Jewishness emerges, rooted less in religious faith than in nationality. In 1897, Alexander Herzl, a journalist, organizes the first of a series of international Zionist congresses, advocating the creation of a Jewish homeland for the Jewish nation. In fact, they want possession of Palestine, which is then part of the Ottoman Empire. The British government offers 6,000 square miles in Uganda as an alternative in 1903, but the Zionist leaders do not consider this an acceptable alternative. No further progress is made by 1914.

## MECCA

Mecca is the religious center of the Muslim world, the goal of pilgrimages by believers from West Africa to the East Indies – the hajj. Because of its sacredness, unbelievers are forbidden to enter the city. In 1853, Richard Francis Burton, in disguise, enters Mecca (see pp. WW108-109); his fluency in Arabic (and many other languages) helps make the trip possible. Other Western travelers who emulate him are taking a risk; if they are discovered, they will suffer dire consequences.

Pilgrims arrive during the first ten days of Dhu'l Hijja, the last month of the Muslim calendar; since the Muslim year is 357 days long (12 lunar months), these days fall on different dates of the Gregorian calendar in different years. Pilgrims wear seamless white robes and must not cut their hair or nails or shed blood. During their stay in Mecca they perform complex rituals, culminating in sacrificing an animal and entering the Kaaba, a mosque that holds a black stone said to have been given to the prophet Abraham by the archangel Gabriel. This entitles them to add al-Hajji to their names and to wear orange turbans, good for +1 Status in any Muslim community.

## JAPONAISERIE

After the opening of trade between Japan and the West, artists begin buying Japanese art, usually prints rather than original works. The resulting movement, *japonaiserie*, becomes an influence on modern art. Degas, Manet, and Monet, among the impressionists, all collect Japanese prints; somewhat later, so does Van Gogh. Japanese furniture influences French interior design as well. Japonaiserie has some influence on the general public, who may not appreciate all the aesthetic nuances but find Japan quaint, exotic, or charming.

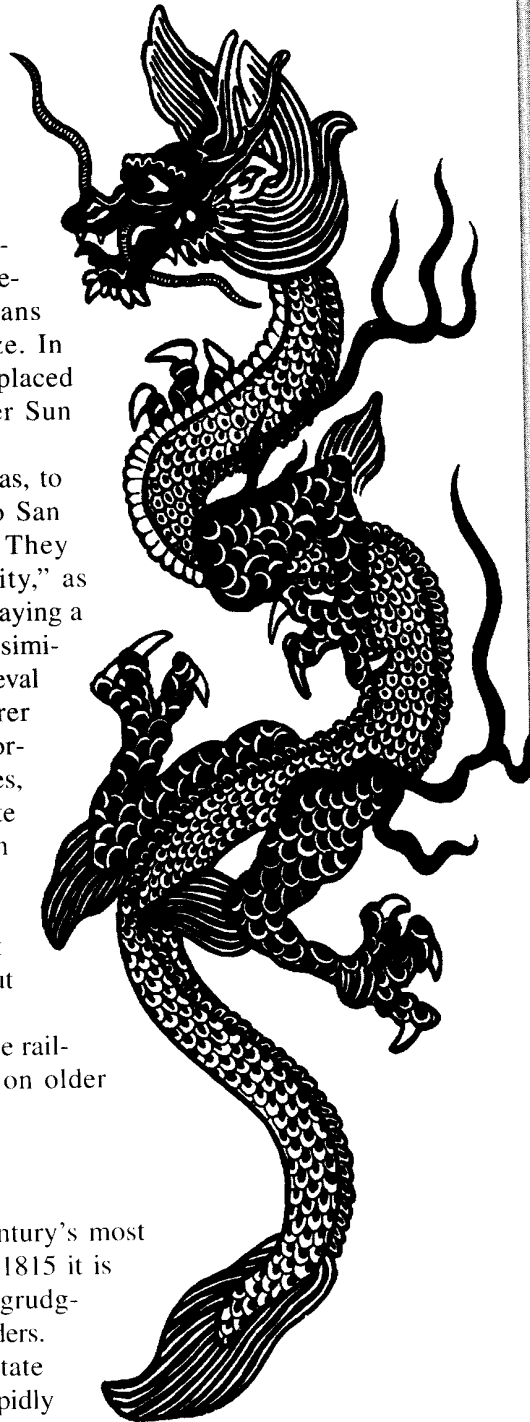



## THE SOUTH SEAS

Europeans tend to hold poor opinions of the tropical regions and their inhabitants; phrases such as “darkest Africa” and “Indian savages” reflect these attitudes. But the Pacific islands and their peoples are often viewed more romantically. They are not spared European control, though it is established relatively late, mostly in the 1890s. But Europeans often praise both the climate and natural beauty of the islands and the appearance and personal virtues of their inhabitants. Paul Gauguin’s paintings of Tahiti help define the European vision of this region.

Travelers in the South Seas may have an exciting time. Before the European takeover, many Polynesian and Melanesian peoples are fiercely warlike. At any time in the century, there are tropical storms to contend with. The larger islands offer other excitements, from volcanos to exotic plants. New Guinea, at the western edge of the Pacific, has the largest area of rugged terrain on Earth; virtually the entire interior is very bad terrain with no roads.

## MISSIONARIES

Throughout the 19th century, the Catholic Church and many Protestant churches send missionaries to non-Western countries; the Orthodox Church does the same in Russia. While their primary purpose is spiritual salvation, they often provide education and medical care. In many African nations, the only source of a European education is the missions. Customs ranging from infanticide to child marriage prove, in European eyes, how desperately Christian teaching is needed. Few Europeans doubt that Christianity is true or that other religions are superstitious idolatry, if not diabolical snares; missionaries hardly ever have such doubts. This conviction sometimes spills over into the belief that any native custom that differs from European ways must be heathen and corrupt, leading to demands that native peoples completely abandon their traditional cultures.

Of course, some missionaries think it necessary to save the natives from incorrect versions of Christianity, as well. This leads in a few cases to interreligious violence not very different from the intertribal violence that took place before the missionaries got there.

In game mechanics terms, a missionary’s attitude to indigenous peoples and customs can be anything from Sense of Duty to Intolerance or even Fanaticism.

The key event in Japanese modernization is the Meiji Restoration of 1868, when the last shogun (commonly called the Tycoon in Western usage) is defeated by the Satsuma, Choshu, and Tosa clans, who then transfer their forces to the control of the emperor (commonly called the Mikado in Western usage, as in Gilbert and Sullivan’s operetta). The capital is moved from Kyoto, seat of the imperial court, to Edo, which is renamed Tokyo.

Japanese culture after the Meiji Restoration is a curious mix of tradition and Westernization. The new system of mass education emphasizes “ethics,” which focuses on the cult of the “sacred and inviolable” emperor whom it is the citizen’s duty to serve. Businessmen and diplomats wear suits in the European style, but in private life traditional clothing remains common. Even the language adds words borrowed from English to native Japanese words and Chinese loan-words. After 1873, Christianity is tolerated, though not encouraged.

## THE DARK CONTINENT

For most of the 19th century there is little European presence in Africa; the interior is unknown territory. European powers begin scrambling for African territory in the 1870s, leading to the Congress of Berlin in 1885, at which Africa is divided up among the colonial powers, creating boundary lines with no relation to the cultures, languages, or religions of the native peoples.

What keeps Europeans out of Africa so long? The main obstacle is the difficulty of travel. Most of Africa is made up of high plateaus with narrow coastal plains; rivers descend steeply, with numerous rapids, and are navigable only by small craft. The difficulties of travel are enhanced in many areas by sleeping sickness, spread by tsetse fly bites, which prevents the use of pack or draft animals. African peoples speak over 1,000 different languages – 20% of the world total, despite having only 7% of the total population. Europeans have mercantile outputs on the coasts, especially in West Africa – the Ivory Coast, the Gold Coast (later Ghana), and the Slave Coast (later Nigeria) –

and the British navy maintains a presence there, but European authority extends only a few miles inland. The main goal of explorers is to map the sources and channels of the great rivers; Richard and John Lander map the Niger in 1830, Richard Burton and John Speke find the sources of the Nile in 1856, David Livingstone follows the Zambezi in 1853-1854, and Henry Morton Stanley maps the Congo in 1874-1877. During this period much of Africa’s trade is in Arab hands; caravans cross the Sahara and merchant ships from Zanzibar land on the east coast.

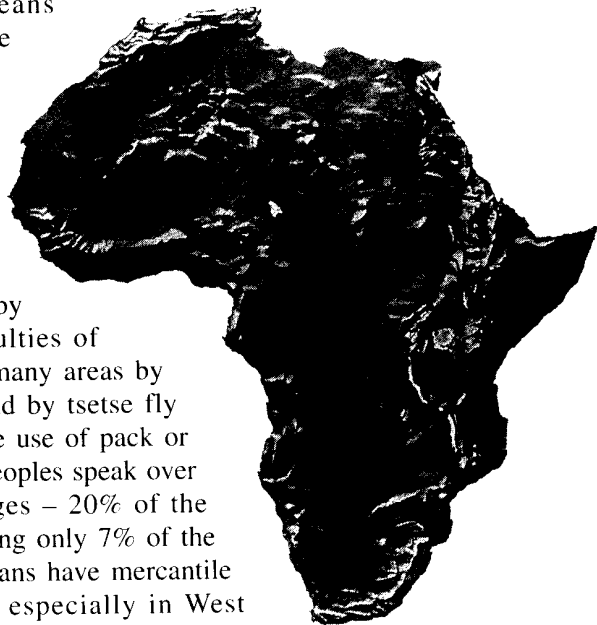

After the Congress of Berlin, nearly all of Africa is claimed by Britain, France, Portugal, and Germany; Leopold II of Belgium holds the Congo as a personal domain (see sidebar, p. 121). Abyssinia (later Ethiopia) retains its independence, as does Liberia, founded by the resettlement of freed American slaves. In southern Africa, the two Boer republics (see sidebar, p. 121) are independent until 1902. Africa becomes a source of raw materials, including diamonds and gold from South Africa, rubber from the Congo Free State, and cocoa and palm oil from West Africa, often produced by forced labor.

Transportation in Africa remains primitive.

## THE PLANETS

The other planets are the remotest imaginable goal for travelers; no one dreams of going to other solar systems. But a TL(5+1) campaign can explore the Moon, Mars, or anywhere else in the inner solar system.

At this point the campaign can go two ways. A hard-edged approach will send Victorian explorers to the planets as we now know them and examine how they might use their technology to survive there – or die if it proves inadequate. A romantic approach will send them to the more Earthlike worlds envisioned by astronomers of the period (see sidebar, p. 97), where they can hope to find breathable or nearly breathable atmospheres and even intelligent natives. For this purpose, here is information on the planets as Victorian astronomers described them:



### MERCURY

Orbital radius: 0.39 AU. Length of year: 88 days. Diameter: 3,000 miles. Density: 7.2. Gravity: 0.50 G. Length of day: 88 days (tide-locked). Atmosphere: trace (replenished from solar outgassing). Albedo: 0.06. Mean temperature: 640° F dayside, 465° F twilight zone, near absolute zero nightside. Terrain: mountainous/volcanic. Type: hot rockball.

Mercury is large enough and has high enough gravity to retain an atmosphere, but on the sunward side the heat makes the atmosphere volatile enough to escape into space; on the dark side drifts of frozen oxygen and nitrogen exist, but no gases. Between the two faces is the “twilight zone,” actually taking up 25% of the planet’s area, a band 750 miles wide; intermittent exposure to sunlight has driven off its atmosphere as well. Still, the planet will be worth exploring; its high density indicates that it is made up largely of metals, averaging closer to the surface than on Earth, and untouched by miners.

### VENUS

Orbital radius: 0.72 AU. Length of year: 225 days. Diameter: 7,700 miles. Density: 5.0. Gravity: 0.88 G. Length of day: 1 day? Atmosphere: very dense, oxygen/nitrogen. Albedo: 0.76. Mean temperature: 116° F. Terrain: marsh/swamp. Type: greenhouse.

### THE BOERS

Britain took over the Cape of Good Hope in 1806 and retained it after the end of the Napoleonic Wars. The 22,000 Dutch farmers living there hold 25,000 black slaves and employ many poorly paid servants, often partly of white ancestry. The British abolish the slave trade immediately, repeal pass laws for servants in 1828, and abolish slavery in 1833. The farmers, or in Dutch *boers*, object to this interference and migrate out of the Cape Colony into land left vacant by warfare with the Zulus under the leadership of Shaka (see pp. WWi96-97). They found two independent republics, the Orange Free State (recognized in 1852) and the Transvaal (recognized in 1854), and become known as Boers. They evolve a distinctive culture, speaking a variant form of Dutch that becomes known as Afrikaans and adhering to a grim Calvinistic Protestantism.

Despite disputes over the diamond fields of Griqualand West, the Boers retain their independence until the end of the century. In 1899 the Boer War breaks out. The Boers prove unexpectedly skilled at guerilla warfare and British troops unexpectedly ill-prepared to fight them. After British victory in 1902, the Boer republics are incorporated into the Union of South Africa, in which 1.25 million whites rule nearly four times as many nonwhites.

### LEOPOLD’S CRIME

In 1876, King Leopold II of Belgium founds the Association Internationale du Congo, a private corporation separate from the government of Belgium. Sir Henry Morton Stanley, who has been unable to gain British support for his expeditions, accepts Leopold’s sponsorship. Leopold’s mercenaries subjugate the region, creating the Congo Free State, which is legally recognized at the Congress of Berlin, despite a joint effort of the British and Portuguese to take it over. Both in the conquest and in the subsequent establishment of rubber cultivation, Leopold’s forces use exceptionally brutal measures that draw protests and criticism from other nations and the general public. One such incident provokes the American poet Vachel Lindsay to write “Listen to the yell of Leopold’s ghost/Burning in Hell for his hand-maimed host.” In 1908, pressure from Britain and the United States leads to Belgium taking over the area, which becomes the Belgian Congo.

## PLACES OF MYSTERY

The 19th century is a great period for places of mystery. Explorers travel to remote locations all over the world; archaeologists investigate ancient civilizations, digging up relics and ruins, as in Heinrich Schliemann's excavation of Troy, or discover ruins of previously unsuspected cities such as Zimbabwe in southern Africa. In a realistic campaign these offer relics for looters to steal or scholars to preserve. In a fantastic campaign they may hold mystical artifacts, or be charged with mana, or be haunted, but not necessarily by the ghosts of human beings.

### LOST CITIES

Many 19th-century writers imagined "lost cities," great metropolises hidden in remote, unexplored parts of the world. Timbuktu offered a model for such realms; located in Mali, on the Niger River, it was once a major center of trade and Muslim learning. While Africa remains poorly explored, it's easy to imagine other such cities – anything from a lost Roman outpost to a matriarchal realm devoted to forgotten pagan rites.

The Americas offer similar possibilities; the birth of American archeology makes surviving Mayan or Inca realms a tempting fantasy. Up to 1869, when a research project sponsored by the Smithsonian Institution proves that the Moundbuilders of North America were Indian tribes, some writers speculate on their having been a higher civilization built by a more advanced, possibly white race; a lost Moundbuilder city could just barely be justified in a cinematic campaign.

Central Asia is another poorly explored region, especially for Western Europeans. Almost anything can be believed of Tibet, as the claims of Helena Petrovna Blavatsky (see p. 8) demonstrate. A less obvious treatment could have a lost Macedonian fortress, perhaps still called Alexandria and speaking a version of Greek; Kipling hints at such a background in his portrayal of Kafiristan.

### AT THE EARTH'S CORE

Another place to conceal lost cities or places of mystery is under the earth. Wildly fanciful speculations made the Earth a hollow spherical shell, with inhabited lands on its interior and perhaps a miniature central sun to illuminate them. Such realms belong only in the most cinematic campaigns. Apart from the structural weakness of any such spherical shell on a planetary scale, objects in the interior of such a shell would experience no gravitational acceleration and thus would float around rather than falling to the outer surface (though they would settle slowly toward the equator because of centrifugal force). The Earth's mass is also known fairly accurately and is much too high to allow any large cavities.

*Continued on next page . . .*

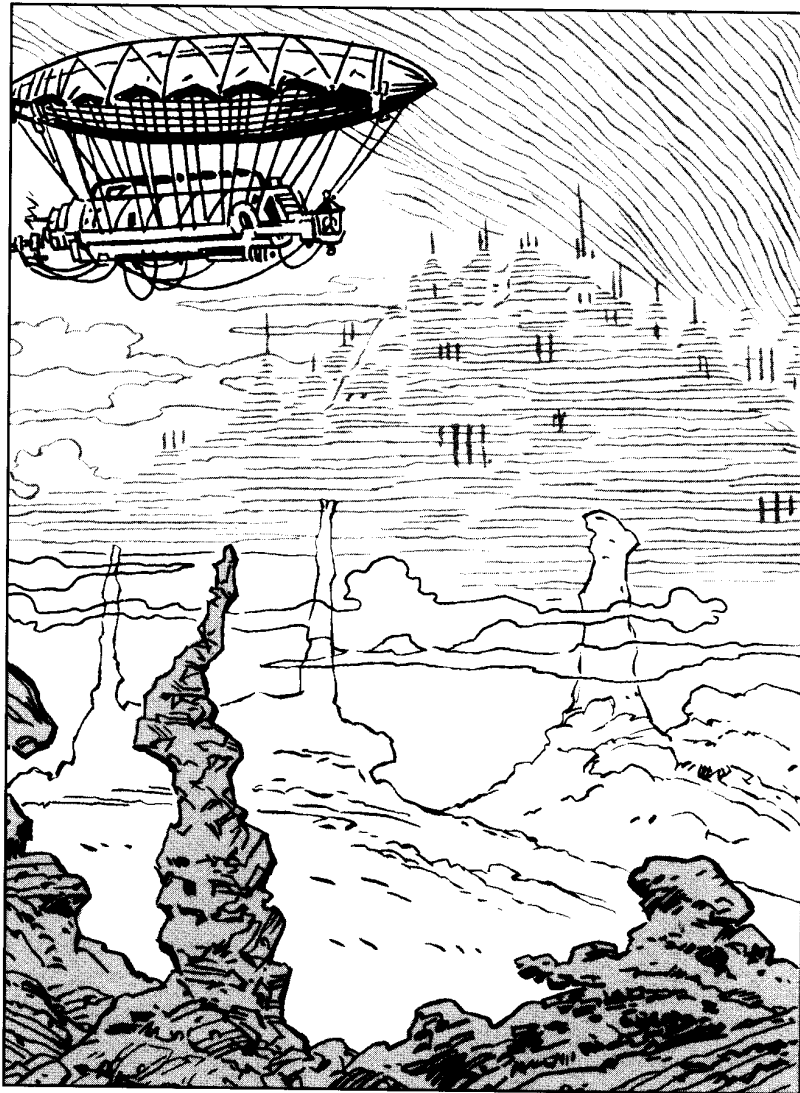

Venus is almost more Earthlike than Earth. The atmosphere is dense, with twice the surface pressure of Earth's atmosphere, and hotter than Earth's also; this gives it a higher ability to retain water vapor. Even so, Venus's air is saturated with evaporation from the 90%+ of the surface that is covered with water, resulting in thick, reflective clouds and nearly constant rain that has eroded most of the planet's mountain ranges. Venus has almost no axial tilt and a nearly circular orbit; its local weather has little variability. Human beings can survive at the poles; closer to the equator the heat and humidity are lethal.

The length of the day is far from certain. A few astronomers believe they have evidence for a rotational period of 150 Earth days. This would subject the native life to drastic temperature changes and probably to weather far more violent than Earth's.

## MARS

Orbital radius: 1.52 AU. Length of year: 687 days. Diameter: 4,200 miles. Density: 4.2. Gravity: 0.41 G. Length of day: 24 hours 37 minutes. Atmosphere: very thin, oxygen/nitrogen. Albedo: 0.15. Mean temperature: 35°F. Terrain: barren. Type: cold desert.

Whether because it is older than Earth or because it is smaller, Mars has lost much of its air and water to space. Its surface is covered with a network of canals that carry polar runoff to the equatorial regions, keeping some vegetation alive, though whether it still nourishes a civilization or any intelligent life is unknown. Mars was always poor in metals and minerals and all its ore deposits are long since worked out. Human visitors find it cold and have difficulty breathing, needing bottled oxygen or compressors. Adaptations to drought and cold typify the planet's life.

## JUPITER

Orbital radius: 5.20 AU. Length of year: 11.86 years. Diameter: 86,500 miles. Density: 1.4. Gravity: 2.78 G. Length of day: 9 hours 50 minutes. Atmosphere: superdense, methane/ammonia. Albedo: 0.51. Mean temperature: -200°F. Terrain: unknown. Type: gas giant.

Any life that inhabits Jupiter must be radically different from Earth's. The planet may not even have a solid surface; if it does it is probably made up mainly of ice. The atmosphere contains no oxygen or nitrogen; it is made up of methane and ammonia and is many times denser than Earth's. Perhaps living balloons drift in Jupiter's upper atmosphere like plankton in Earth's oceans. It will be a long time before human beings can go there.

## SATURN

Orbital radius: 9.54 AU. Length of year: 29.46 years. Diameter: 73,000 miles. Density: 0.75. Gravity: 1.26 G. Length of day: 10 hours 14 minutes. Atmosphere: superdense, methane/ammonia. Albedo: 0.50. Mean temperature: -270°F. Terrain: unknown. Type: gas giant.

Saturn is much like Jupiter, but smaller, farther out, and colder. Its gravity could be supported by the human frame, but its cold and poisonous atmosphere would require advanced life support. The only reason to go there would be a romantic one: to see the planet's unique rings close up.

Uranus and Neptune are more of the same, and so remote that no human being is ever likely to approach them. Beyond them are the cometary belts and the void between the stars.

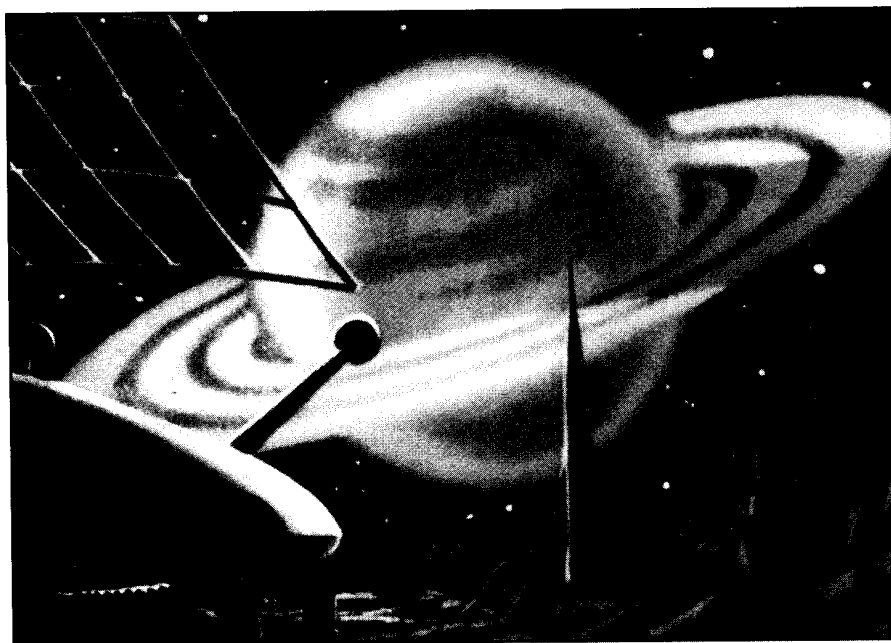

## PLACES OF MYSTERY

(Continued)

However, a smaller underground realm, perhaps occupying a vast cavern, is easier to justify. Jules Verne describes such a realm, lit by electrical luminescence in the dense atmosphere, with a sea occupied by prehistoric monsters and a distant glimpse of a gigantic primitive man herding mammoths. Of course, some 19th-century geologists already know that the interior of the Earth is too hot to allow liquid water, but Verne is able to find other geologists to support the more convenient assumption of a cool inner Earth.

## THE PLANET VULCAN

In 1859, analyzing the orbit of Mercury, the French astronomer Urbain Jean Joseph Le Verrier shows that its perihelion (the point in its orbit closest to the sun) shifts over time, 565 seconds of arc in a century. The attraction of the other planets explains 527 seconds of the shift; the other 38 seconds are unaccounted for. Their true explanation will only be found in 1915, when Albert Einstein will use his general theory of relativity to calculate the sun's gravitational field and find that it exactly predicts the discrepancy. Le Verrier, relying on Newtonian mechanics, thinks the explanation is a planet or a group of smaller bodies orbiting closer to the sun than Mercury, as the planet Neptune accounts for Uranus's orbital irregularities. An amateur astronomer, Edmond Modeste Lescarbault, reports the observation of such a body later that year, and on January 2, 1860, Le Verrier reports the discovery to the Academie des Sciences. The new planet is named Vulcan.

Of course, since Vulcan doesn't really exist, it proves difficult for astronomers to confirm Lescarbault's discovery or to compute Vulcan's orbit; debate over whether it really exists continues for the rest of the century. But in a steampunk world where Newtonian physics is true, Vulcan may really exist.

Based on Le Verrier's calculations, here are Vulcan's characteristics as a planet:

Orbital radius: 0.17 AU. Length of year: 26 days. Diameter: 1,100 miles. Density: 6.5. Gravity: 0.16 G. Length of day: 26 days (tide-locked). Atmosphere: trace (replenished from solar outgassing). Albedo: 0.06. Mean temperature: 1220°F dayside, 950°F twilight zone, near absolute zero nightside. Terrain: mountainous/volcanic. Type: hot rockball. Mineral resources are likely, if anyone can survive long enough to exploit them.





# CHAPTER 8 STEAMPUNK CAMPAIGNS

*“Serpentine proceeded to explain that just as it would be possible for any number of practically two-dimensional universes to lie side by side, like sheets of paper, in a three-dimensional space, so in the many dimensional space about which the ill-equipped human mind is still slowly and painfully acquiring knowledge, it is possible for an innumerable quantity of practically three-dimensional universes to lie, as it were, side by side, and to undergo a roughly parallel movement through time.”*

*– H. G. Wells, “Men Like Gods”*

# BUILDING THE CAMPAIGN

Many books on roleplaying games make the point that running a campaign is a form of storytelling. The fiction of the 19th century provides a rich resource of storytelling ideas, in many different flavors and genres, ranging from serious explorations of philosophy, psychology, and social issues to classic adventure stories – sometimes all in one novel. Verne, Wells, and other writers of their time created what we now call science fiction. A little reading and research into these works can serve a GM well.

To start with, consider certain basic elements of fiction: mood, theme, premise, and style. Each has an analog in roleplaying. Together, these elements make a campaign what it is.

*Mood* is so basic that it often isn't thought about at all. But the emotional tone of a campaign can make players love it or hate it. Consider the difference between a campaign of high excitement and optimism, a campaign with recurring scenes of terror, and a campaign of steady grim struggle with no prospect of victory or relief. All three could be retrotech, but they would appeal to different sorts of players.

More than anything else, mood depends on what consequences players expect from characters' actions. For a sense of adventure, let the characters succeed most of the time. For comedy, have them fail frequently, but with no long-term harm resulting. For horror, give them a few large defeats; for dystopian grimness, a steady stream of small ones. For drama, occupy the middle ground between these choices, so that players have the strongest possible sense that victory or defeat turns on what their characters do.

In creating a mood, pay careful attention to details. In a horror campaign, for example, showing a single rat crawling between the bricks of a tomb is no threat to any adventurer, but creates feelings of revulsion that help prepare the players to take the real menace seriously.

*Theme* is much like what Hollywood calls "high concept." The theme of a campaign is the one underlying idea or motif that runs through all the episodes. Ideally, each episode develops and explores one variation on the theme. Age of Steam campaigns have four main families of themes:

- **High Adventure.** Campaigns of this type try to recreate the feeling of classic adventure stories. Suitable themes include exploration, quests for treasure, rescue missions, defending one's homeland, upholding the law, and matching wits with criminals.

- **Dystopia.** The Victorian era's fears about its future and the 20th century's awareness of Victorian failings can both contribute to this type of campaign. Suitable themes include the struggle for survival, crime and intrigue, revolution and conspiracy, and law enforcement in a corrupt world.

- **Scientific Wonders.** In the middle ground are campaigns focused on new scientific discoveries and creations. The focus can be the discovery itself – of an object, a being, or a new world – or the transformation of society and human life, or the lives of those transformed or created by science.

- **Heroic Engineering.** This is the other side of the Scientific Wonder campaign: the goal is not to discover some new marvel, but to construct it. Such campaigns have much of the flavor of High Adventure, but emphasize getting the job done, from surviving a shakedown cruise or test flight to building a transcontinental railroad to visiting other planets.

*Premise* is the other concept-driven part of campaign creation. The premise is the basic fact that makes a campaign world different from the real world. In alternative history campaigns – and Age of Steam retrotech normally involves alternative history – the premise is the historical branch point.

## CROSS-GENRE CAMPAIGNS

Several *GURPS* supplements have obvious relevance to a steampunk campaign: *GURPS India* and *GURPS Old West* as historical sourcebooks and *GURPS Castle Falkenstein* as an actual steampunk setting. Here are some less obvious crossovers:

### GURPS ALTERNATE EARTHS/ TIME TRAVEL

A steampunk world could turn up in a paratemporal campaign such as the Infinity Unlimited setting (pp. TT83-112). An alternative technology setting might be anything from an appealing Time Tours destination to a grim candidate for intervention or a potentially dangerous ally for Centrum. A weird science world with different natural laws would be treated much more cautiously!

For a different slant, suppose a Victorian time traveler discovered a future dystopia or a stagnant, decadent humanity and set out to change the course of history? Other time travelers might find evidence of mysterious interventions, or they might *be* the agents behind those interventions.

### GURPS DINOSAURS

The 19th century had many enthusiastic dinosaur hunters, including the notorious rivals Cope and Marsh (see p. 9). Even a realistic campaign could send explorers out to discover fossils. But a classic motif of Age of Steam science fiction, including Jules Verne's *A Journey to the Center of the Earth* and Arthur Conan Doyle's *The Lost World*, is the survival of "living fossil" dinosaurs. Any of the "lost realms" possibilities discussed in *GURPS Dinosaurs* (pp. D116-118) could be used in a steampunk campaign – the entire planet Venus might be such a realm thanks to parallel evolution.

Or variant biological laws might allow a scientist to recreate extinct species. For a different sort of high adventure campaign, what if such an experiment found military applications? The adventures of the Imperial Ceratopsian Armored Cavalry could be the subject of an entire campaign.

### GURPS HORROR

*GURPS Horror* already has a Victorian setting (pp. H77-94). A judicious use of weird science concepts (pp. 94-108) offers many inspirations for horror. Who knows what dark threats may hide in the tombs of the ancient Martians, or deep under the streets of a hyperurbanized London?

*Continued on next page . . .*

## CROSS-GENRE CAMPAIGNS

(Continued)

### GURPS PSIONICS

Mediums, mesmerists, and psychic researchers pervade Victorian literature; a campaign could focus on their activities. Chapter 6 offers rules variants suited to the Victorian milieu (p. 103). This type of campaign could shade over into horror, especially if psychic phenomena include the spirits of the dead.

### GURPS ROBOTS/REIGN OF STEEL

They won't be called "robots" or "androids" or "cyborgs"; all those words were coined after 1914. But a steampunk campaign might feature artificial beings in a variety of roles: a new source of servants, laborers, or soldiers; high-point-value Allies or Patrons; deadly threats to humanity; or outcasts hiding from a world that considers them property or public dangers. (The "revolt of the robots" in Karel Capek's *R.U.R.*, which coined the word "robot," reflects Victorian anxieties about the working class.)

The *Reign of Steel* setting assumes post-steampunk technology. But an analog could be developed in steampunk terms, with a genius option megafame analytical engine spontaneously becoming sentient (Complexity 7, IQ 12) and setting out to subjugate humanity with the aid of great steam-powered automata.

### GURPS SUPERS

Superheroes are an anachronism in a steampunk setting. If they are used straight, considerable effort will be needed to explain secret identities, colorful costumes and names, and the rest of the formula. The superhero ethic differs from 19th-century codes of honor – for one thing, unwillingness to use deadly force is rare in the 19th century.

Still, the basic formula can plausibly be traced to Baroness Orczy's *The Scarlet Pimpernel*, published 1905 (see *GURPS Scarlet Pimpernel*). Many fictional characters of the period have extraordinary skills or inventions or even superpowers. A campaign bringing some of them together, as a select club or a secretive branch of government, might encompass a wide variety of missions and adventures. Powers, though, must be restricted: flight without obvious means of support, energy blasts, or bodies of normally nonliving materials are not idiomatic, and powers based on genetics or radioactivity are outside the scientific paradigm of the era.

*Continued on next page . . .*

But the idea applies more widely than that. H. G. Wells defined his approach to "scientific romance" as making one impossible assumption and working out its implications. Even realistic fiction starts out by making assumptions, though not impossible ones.

The premise for a retrotech campaign is a technological difference: that some invention was made early, or was not made, letting technology evolve on a different path. But this different technology is the start of a different history or the outcome of one. And it may be possible only because the laws of nature are different; if so, the campaign has a weird science premise as well as an alternative technology one.

Finally, *style* is the way the campaign is actually played. For example, is it realistic or cinematic – are the probabilities in the game similar to those in the real world, or are they modified to make the story more dramatic? Is the pace fast, with time spent mostly on action, or slow, with long intervals of everyday life and character development? Is violence clean or graphic; is sex dealt with openly or kept offstage?

Note that "cinematic" need not mean "favorable to the adventurers." Personal horror or political oppression can be dramatically exaggerated as easily as heroic endeavor. Any list of great dramatic characters would have to include a share of villains.

## WORLDS OF WONDER

To illustrate these options for campaign design, here are four sketches of campaign worlds. All four are retrotech in some form. Beyond that, they have as many differences as possible. Etheria has only minor divergences from real 19th-century history, up to the point where etheric science allows the creation of a reactionless drive. Iron diverges farther and offers a dark vision of the 20th century. Qabala begins industrialization in an entirely different time and place, on an entirely different technological basis, and is already on a far different historical path by 1800. Providence seems not to diverge at all, but secret technology changes the political and social dynamic of their alternate history.

### ETHERIA

*The heat of Venus was beyond anything Charles Arthur Leslie had imagined, even after five years' service in India. Sweat poured down his back and matted his hair, unable to evaporate in the saturated atmosphere.*

*Which way was the camp again? It was hard to think in this d--ed heat. He shook his head, slowly, wishing for a hint of motion in the air to clear his thoughts.*

*He must not get separated from the camp; Professor Brainerd's refrigerating engine was all that kept them alive. They had dragged it miles through the primeval swamps, further north than any human being had ever come – or at least lived to tell of. Three miles on a good day, week after week . . .*

*He looked around, trying to make out landmarks in the vaporous air.*

*A splash sounded off to his right. He thought he made out someone coming toward him. Then the figure came closer and he realized it was one of the Venerian amphibian-men, shorter and slighter than a man and with a fringe of hair about its loins – no, not hair exactly, some sort of tendrils, as fine as hair. Primitives, all of them, inferior even to the hill tribes of India in intelligence and the civilized arts. What did this one have on? He'd never seen a frogman wearing that kind of harness, with strange objects dangling from it.*

*Before he could see it closely, he collapsed onto the muddy soil.*



Etheria is a world where different natural laws have allowed the expansion of European colonialism into outer space. Explorers and colonists have discovered intelligent races on Mars and Venus; diplomats scheme to add Venus's plantations and Mercury's mines to European empires. Amazing scientific wonders coexist with iron-framed structures and steam engines.

The campaign year is 1890. The year of divergence is 1824. The critical event is Lord Byron's surviving to see the Greeks win independence from the Ottoman Empire – and, two years later, to accept the Greek throne as King Giorghios.

### History

In 1834, Augusta Ada, Byron's daughter by his first (English) wife, visited her father in Athens. She spoke often of her friend Charles Babbage. Byron found Babbage's ideas on the collection of social statistics and the improvement of manufactures interesting; he offered him an advisory position and later a ministry. Babbage's work created a precision machine industry that gave Greece industry and advanced weapons. In the Balkan War of 1863-1865, Russian manpower and Greek automatic weapons overwhelmed the Ottoman Empire. Byron's son Giorghios II was crowned in Constantinople in 1866.

In 1875, a student at the University of Athens, Nikola Tesla, showed that an electromagnetic device could exert force against the luminiferous ether. Six years later Tesla made the first interplanetary voyage to Venus and back. Tropical forests on Venus and mineral deposits on Mercury became the focus of colonialism, leaving Africa largely forgotten. The amphibious primitives of polar Venus were turned into indentured servants or outright slaves; some were even imported to Brazil, where their presence encouraged the freeing of black human slaves. The ancient ruins of Mars held interest only for archaeologists, and no one dared land on molten Vulcan.

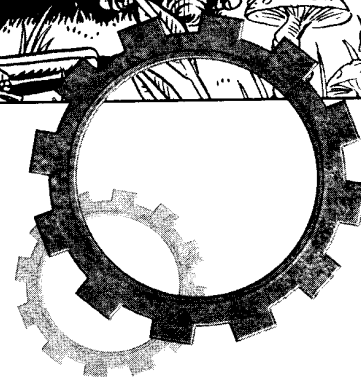

### CROSS-GENRE CAMPAIGNS

(Continued)

#### CURPS SWASHBUCKLERS

Officially the era of swashbuckling adventure ended with the Napoleonic Wars. Don't you believe it. The 19th century had many opportunities for swashbuckling. The gentleman's code of honor (see p. 45) was widely adhered to. Duels were illegal, but often overlooked. Wars included cavalry charges with drawn sabers and naval boarding parties. The exploration of the world and possibly of the other planets provides numerous settings for wild adventure.





## BEING ETHERIAN

Etherians are adventurers, above all. Tesla's inventions gave them access to the solar system when the European expansion was at its greatest height. The now interplanetary British Empire embodies this spirit, but other nations have similar aspirations: Americans talk of bringing liberty to the other planets. Frenchmen of the *mission civilatrice*. Greeks of the Athenian heritage. Patriotism is highly regarded, and national space ventures offer a perfect expression for patriotic pride.

Etherians are not likely to doubt the superiority of their own civilization and their own customs. The customs of other lands don't strike them as evidence of different standards, but as evidence that foreigners lack standards. They are inflexible even in small matters, such as dressing for dinner in the hottest jungle. The same inflexibility can be seen in their emphasis on keeping one's word and carrying out one's commitments. The man who fails to do so, because of inconvenience, hardship, or even mortal danger, is regarded as lacking character and may find himself an outcast. Getting a bad name is the worst fate many people can imagine.

## ETHERIA'S WORLD OF THE MIND



The exploration of Mars and Venus has not shaken the confidence of Etherians in their central role in history. A world of half-starved nomads wandering in the ruins of a fallen civilization and a world of naked tribal peoples obviously cannot compete with human achievements. The great powers have begun to export their experience in colonial administration into outer space, looking forward to a solar system under human rule.

However, other intelligent races raise major questions for the churches. Martians and Venerians cannot be descended from Adam or share in original sin. Are they unfallen, and in no need of salvation? Or did they have their own fall, and did Christ's human birth mean that God chose Earth for salvation, while the other races are barren soil? Some very practical worldly questions follow from this, including whether the churches should oppose nonhuman slavery.

*Continued on next page . . .*

## Technology

Etheria is based on two weird science premises: the luminiferous ether and habitable planets. Reactionless spacedrives can propel a ship anywhere in the inner solar system. Flight within the atmosphere is less developed than interplanetary flight, as reactionless drives are inefficient in so dense a medium. Most travel is by rail or steamship.

Other etheric innovations are also possible, at least for characters with suitable advantages such as Invention or Gadgeteer. See Chapter 6 (pp. 94-108) for some possibilities. Neither radio nor etheric shock has been developed yet, but there have been experimental tests of vacuum-filled airships strengthened by etheric force fields.

The other area where technology is definitely at TL(5+1) is precision machining. Fully automatic weapons and long-range artillery are coming into general use. The Greek government has funded a few analytical engines, mainly for military purposes, though the University of Athens has one; a few other governments have projects along the same lines.

A referee wanting further exotic technologies can turn to pharmaceutical chemistry. The jungles of Venus may be a source of any number of exotic drugs, medicinal or recreational. This is especially the case if the GM allows players to encounter the advanced societies of equatorial Venus (see sidebar, p. 130).

## The Great Powers

The British Empire is Etheria's greatest power. Administered from London, it encompasses dominions, colonies, and protectorates on every continent – and since 1884, Cytherea on South Polar Venus and Erebus on Mercury, with scientific missions going to Mars but no territorial claims there. The mines of Erebus have replaced Botany Bay as a dumping ground for convicted felons.

The United States of America has grown rapidly in economic output and military power. By 1891 it is an important regional power in the New World. As yet it has engaged in no official ventures beyond the atmosphere, but American mining camps have grown up in the Mercurian twilight lands, inhabited by men crazy enough to venture into hell for profit.

Europe's second power is Germany. Military discipline, administrative skill, methodical research, and rapid industrial growth back up the world's most professional army. Like Britain, Germany has colonies on both Venus and Mercury.

Rapidly overtaking Germany, thanks to Babbage's industrial schemes, is the Greek Empire. Now governed from Constantinople, Greece has seized Crete, Cyprus, and Tunis. Greek intelligence agents can be found throughout the Balkans and the Near East and in major capitals elsewhere, equipped with the advanced encryption schemes that Babbage helped develop.

Russia has profited from alliance with Greece, seizing the Turkish and Persian portions of Armenia and expanding through Central Asia toward British India. Russian prisoners work in the mines of Mercury as well as in Siberia. King Leopold of Belgium has seized large tracts of North Polar Venus and exploited them brutally. France, the Netherlands, and Japan have small possessions on Venus also. A complex balance of power keeps the peace in Europe. The Balkans are still explosive; one of the Greek Empire's main goals is to stabilize them.

## Analysis

Etheria is the Victorian Era with something added: weird science premises that bring outer space within its reach. Suitable themes for this setting are various sorts of high adventure. Scientific wonders and heroic engineering are other possibilities, but it's best to de-emphasize the technicalities. The style of most campaigns should be cinematic, with larger-than-life heroes; Status and Wealth should be common advantages.

## Adventure Seeds

*The Lost City.* An emissary from the Greek Empire attempts to recruit adventurers for an unofficial mission: Four years ago, a party of soldiers and civilian scholars set out into the desert south of Tunis. They have not returned. Can the adventurers follow their trail? But their fate is unexpectedly strange: In the central Sahel, a city founded by a Roman legion still maintains ancient Roman customs, including paganism, slavery, and deaths in the arena. How will explorers deal with soldiers in bronze armor speaking a very odd Romance language – and mostly having black skins?

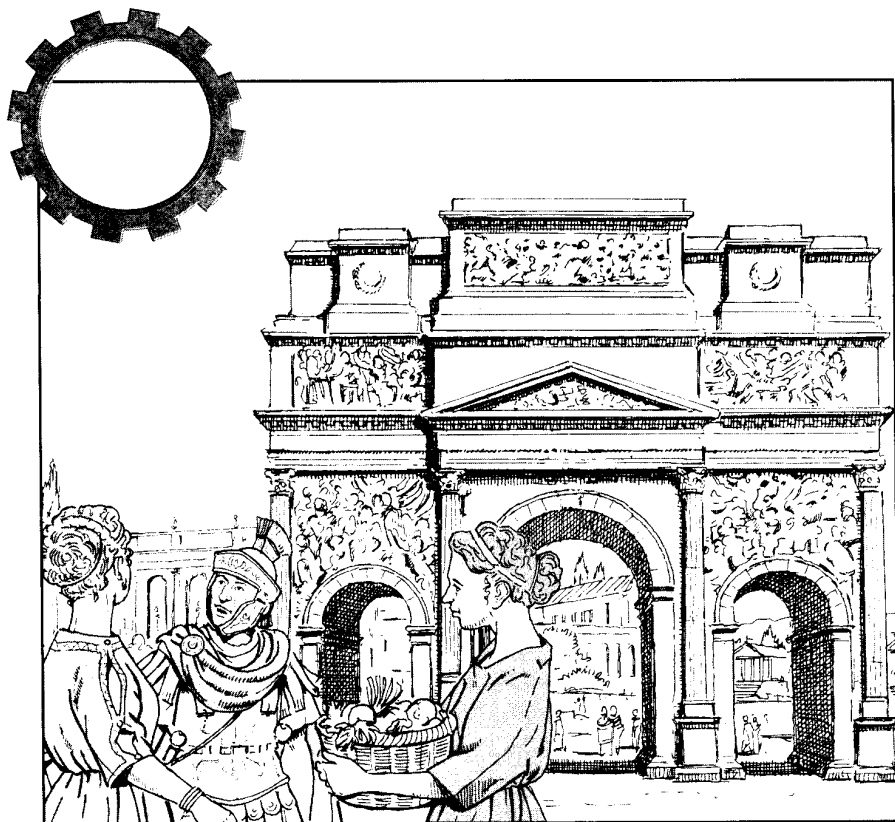

*The Submarine Pirates.* The shipping authorities and the Navy have a problem: ships have been found drifting off southern England, their crews dead and mutilated and their cargoes missing. The investigators find peculiar bite marks on the corpses, characteristic of Venerian amphibian-men. A scientist has developed a drug that overcomes Venerian lethargy in England's cold seas and a submarine that can transport them to raid coastal shipping; not needing to be sealed simplifies its design. The ravenous hunger his drug induces in his Brazilian-bought slaves is an unexpected side effect, but has not induced him to give up his piratical enterprise.

## ETHERIA'S WORLD OF THE MIND

(Continued)

The ruins of Mars are older than any human structure, raising questions about the chronology of Genesis. Mars certainly looks like an ancient, dying world, Venus like a young, flourishing one, seeming to confirm geologists' theories about the age of the Earth. In the conflict between science and Biblical literalism, science has gained strength from such evidence. An increasing number of Etherians believe that ethical standards require a nonreligious foundation, though no one agrees on what that might be.

The Martian ruins raise disturbing questions about the future of humanity. Is Earth, too, destined to grow old, with ignorant barbarians wandering in the ruins of London, or even ultimately to break up into a new asteroid belt? Or can a more civilized humanity preserve the world, or migrate to another planet as the sun cools?

## VENERIANS

Venerians are humanoid in body shape, though they average 3" shorter for a given ST. Their skins are moist, like those of frogs or salamanders, and colored blue-green from the hemocyanin in their bloodstreams. A fringe of delicate filaments descends from their abdomens; while it resembles hair, the filaments actually are alive and appear to be involved in respiration.

Venerians have ST -2 [-15] and -2 HP [-10]. The Venerians so far encountered by human beings have DX -1 and IQ -3, but these reflect a more complex racial trait. Venerian advantages are Amphibious [10], Flexibility [15], Gills [10], and Sensitive Touch [10]; they also have eyes that are sensitive to the polarization of light, enabling them to see the sun's position through cloud cover, which gives them Absolute Direction during the daytime only [4]. Their disadvantages are Chummy [-5] and a Weakness: if exposed to temperatures below 80°F they suffer 1d6 HT loss per 30 minutes [-5].

Continued on next page . . .





## VENERIANS

(Continued)

Venerians are cold-blooded and their metabolic rate varies with the temperature of their environment. At 120°F they have DX 10 and IQ 10. For each 10°F temperature increase or decrease they have +1 or -1 IQ; any IQ loss is accompanied by -1 DX and any IQ gain by +1 DX. The point values of IQ loss average to -15, and the point values of IQ gain to +20; averaging -15, 0 (for no change), and +20 gives an averaged cost of 2 points for their variable IQ. The cost of their variable DX works out to 0.

Human beings have only seen Venerians at the poles, in whose 90°F climate they are clumsy and barely sentient, living in primitive tribal communities and speaking Mental/Easy languages. Venerians in the lethally hot equatorial regions have average DX 11 and IQ 13 and maintain sophisticated civilization at whose existence no human being has guessed; their languages are Mental/Hard, with grammars expressing complex social relationships and emotional nuances.

It costs 16 points to be a Venerian.

## IRON

*Carolyn Vanderbilt's visitor was a nondescript man, respectably dressed in a dark suit and stiff white collar. Only the good quality of his clothing set him apart from the settlement house's usual visitors. He passed a card across to her; it read "Daniel Waters, Attorney at Law."*

*After a moment or two for polite conversation, she said, "I hope you will pardon my directness, Mr. Waters, but I have a great deal of work before me. I was told that you wished to present an offer of financial support to my agency. Certainly we can use such help; what amount are you offering, for what purpose, and on whose behalf?"*

*He nodded slightly, as if in appreciation. "I represent the Pinkerton Agency, Miss Vanderbilt. I am sure you are aware that we use analytical engines a great deal in our work. It is our policy to support charitable efforts such as yours; we believe that machine records can be applied as well to social work as to criminal investigation and are purchasing machines for interested agencies."*

*"Our interest would be greater, had we any staff member with skill in operating such machines."*

*"That need present no difficulty. As part of our grant, we would pay the cost of a Pinkerton-trained operator, on a continuing basis – either an employee of ours who wishes to be seconded to charitable work, or a member of your staff whom we would train."*

*"And would this person understand that information so received must be held in confidence?"*

*Waters leaned forward, as if she had just made an unexpected bid at the bridge table. "Of course, we would wish to have your cooperation in sharing*

records. The criminals with whom we deal and the poor whom you assist are too often the same people; both our functions can be performed more expeditiously with access to each other's knowledge of them." His eyes weighed her reaction.

Iron embodies the 19th century's expectations for progress, and its fears as to what that progress might cost. Its theoretical physics is classical, its technology is powered by steam, and its inventors devote themselves to mechanics and chemistry, not to electricity. Politically, too, it has experienced further development of 19th-century approaches, rather than revolutionary change.

The campaign year is 1925. The year of divergence is 1843. The critical event is a visit by the manufacturer Friedrich Engels to Charles Babbage.

## History

On an early visit to England, Engels was invited to the home of Babbage for the weekend. What he heard there changed his life – and many others. Babbage talked of social statistics as a basis for more informed governmental decisions; of steam-powered analytical engines that could process this information, swiftly and unerringly; of precision machining and the scientific analysis of industrial processes to end waste. Engels went home and wrote a long letter to his friend Karl Marx. In the years that followed, Marx and Engels held up the analytical engine as the key to scientific socialism.

The first attempt to put these ideas into practice came from an unexpected source. During the unification of Germany, Bismarck adopted such socialistic proposals as old age pensions to forestall labor troubles. The socialists' call for mechanical computation caught his interest. Soon German factories were making analytical engines, initially for sale to the German government, which applied them to military planning and strategic simulation, cryptography and ballistics, and recordkeeping in general, until it was said that every taxpayer had a file.

At the same time, the railroads, especially the transcontinental railroads of North America, found the new machines invaluable for planning schedules and analyzing traffic flow patterns. They were the first to link analytical engines to telegraph lines, though the German government quickly adopted the idea.

In 1853, a student of James Clerk Maxwell asked his opinion of Engels's book on computational engines and the scientific economy. Maxwell vehemently disagreed with Engels's theories and wrote a book criticizing them, *The Dynamics of Production*, whose theories were modeled on his earlier work on statistical mechanics. Maxwell's defense of unequal wealth as the source of useful social work gave advocates of capitalism renewed intellectual confidence; his general theories made the first steps toward a predictive social science.

Over the past 50 years, Germany has moved steadily toward mastery of Europe. The General Staff uses analytical engines to run elaborate strategic simulations and draw up contingency plans. Campaigns are directed toward limited objectives attainable with available resources. Above all, Germany has held off on invading Russia. A series of controlled wars have made Alsace-Lorraine, Schleswig-Holstein, and Lithuania German territories. Austria-Hungary is a junior partner and a useful tool in Germany's domination of the Balkans.

German domination in Europe was accelerated after the Fashoda incident led to a major European war: Britain against the French/Russian alliance. Britain emerged victorious but economically drained and took possession of key French territories in Africa, which absorbed British energy for a generation, notably in finally building the Cape-to-Cairo railroad.

## MARTIANS

The last survivors of a dying planet, Martians lead harsh and impoverished lives. They are built for low gravity, averaging 12" taller than a human being of the same ST, with dry skins that resist desiccation and nictitating membranes that screen their eyes against the Martian sand.

Martians have ST -6 [-50]. Their advantages are Acute Taste and Smell +3 [6], Cast-Iron Stomach [10], Damage Resistance 2 [6], Decreased Life Support [10], Metabolism Control (20% normal rate, limited to hibernation) [20], Nictitating Membranes [10], Oxygen Storage [14], and Single-Minded [5]. Their disadvantages are Callous [-6] and Edgy [-5]. It costs 25 points to be a Martian.

## BEING IRONIC

Citizens of the progressive nations, such as Germany, Japan, Sweden, and the United States, are brought up with two seemingly incompatible standards of conduct. They are expected to be strong-willed, ambitious, and competitive. They are also expected to work for some larger organization, putting its goals ahead of their own. The nuances vary from nation to nation; Germans think primarily of military service, Americans of a job with a major corporation, the Japanese of the cult of the Emperor.

All these larger organizations are hierarchical, and promotion is ideally by merit – performing notable services or learning useful skills. Citizens compete in meeting the expectations of their superiors. In addition, large organizations within a nation compete with each other, and nations are constantly preparing for war; working for victory in these struggles offers an outlet for competitive impulses.

The formal courtesies of the 19th century are dying out. Iron prizes directness, practicality, and speed. Increasing numbers of people crowd into big cities, where last year's arrivals look down on this year's as ignorant hicks. Germany and Japan have turned aristocrats into businessmen and officials, and feel gentle contempt for Britain, which maintains landed estates and leisured manners. Modern people are expected to tolerate, or actively enjoy, noise, crowds, and a fast pace.

## IRON'S WORLD OF THE MIND

Iron's intellectuals put curiously little value on the intellect. Using one's intelligence in practical tasks, such as engineering, medicine, or war, is admired; using it for its own sake is not. Spiritual concerns get even less support. Religion is considered beneficial as a way of building character, but the point of having good character is to lead a successful worldly life.

Iron has embraced Darwin's phrase, "the survival of the fittest." Fitness means health, which means the balanced development of the whole organism; too much intellect or spirituality is seen as morbid. There is a great deal of concern with the degenerative effects of civilized life, and eugenicists call for countermeasures, from sterilizing the unfit to subsidizing child-bearing by people with desirable traits.

This emphasis on planned breeding is one aspect of a general belief in planning and administration. The use of analytical engines to collect social statistics and plan strategies made a great impression on Iron's intellectuals. They take it for granted that experts can collect relevant information, make a plan of action, and issue orders based upon it – and have everything work out. For example, military general staffs draw up battle plans for a great variety of possible wars. There hasn't been a major war in a generation, so not many officers remember that "no battle plan survives contact with the enemy."

## THE PINKERTONS

After the Civil War, Pinkerton and Company found increasing demand for their services in suppressing labor unions, especially after their work against the Molly McGuires in the 1870s. Allan Pinkerton's last major business decision was to purchase an analytical engine to keep files on criminals and subversives. Pinkerton had learned of Alphonse Bertillon's work on criminal identification (see sidebar, p. 62) and ordered that records be indexed by anthropometric statistics if these were known; full face and profile photographs were attached to aid in identifying suspects. Police and security agencies in other countries followed his example. The massive investment in this mechanical filing system and the difficulty of adapting it to work with fingerprints delayed the general adoption of fingerprinting; in 1925 the Pinkertons are considering changing over, but neither Germany nor Japan has done so.

The American political system is heavily dominated by large corporations; Pinkerton and Company is effectively the American national security agency, despite being a business firm.

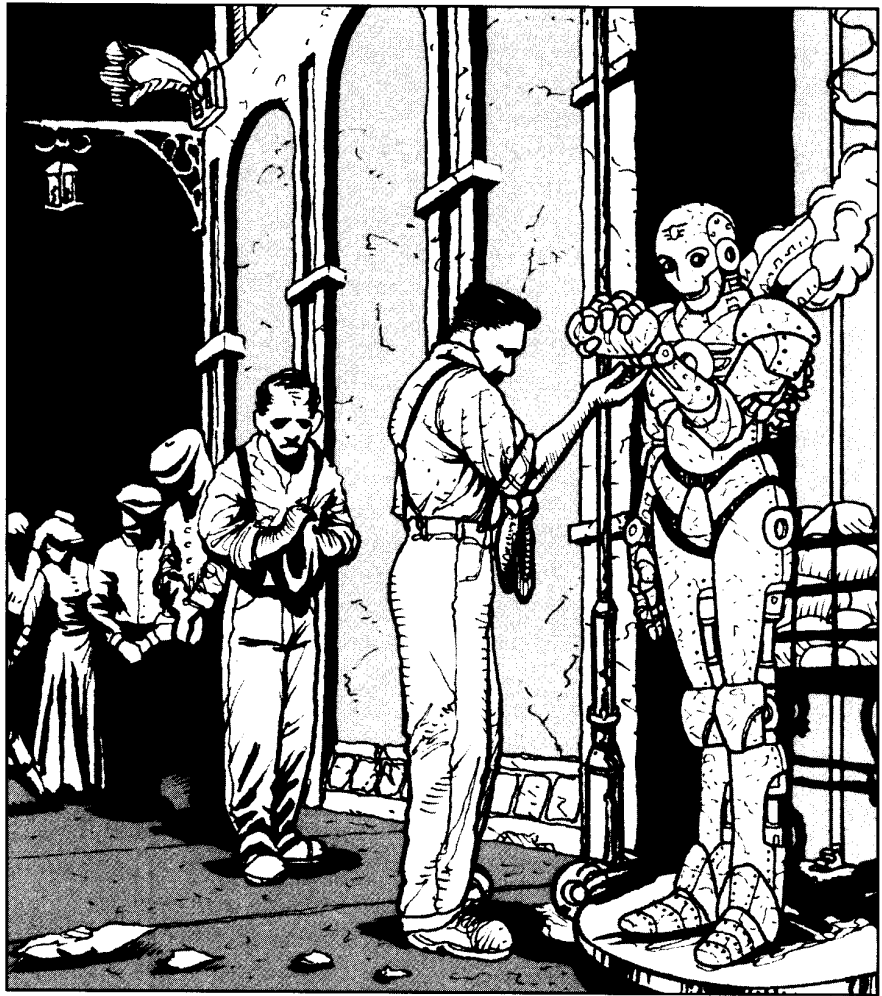

## Technology

Iron is a world of steam and steel. Maxwell never became interested in electricity and magnetism, and thus never predicted electromagnetic waves traveling at the speed of light. Instead, his work in thermodynamics helped his society to develop more efficient steam engines. Electricity is used in relay-based control devices, in the telegraph, and in the telephone, but radio is undreamed of.

The triple-expansion cylinder engine has given way to the steam turbine, and coal is being supplemented by petroleum fractions. Factories have huge engines linked to elaborate systems of belts and gears; smaller engines are common in workshops and even vehicles. Increased investment in steam machinery by German and American industry made it sufficiently cheap to be used in road vehicles.

However, steam has not proved easily adaptable to aircraft, so the airfoil is underdeveloped; a few experimental gliders have flown, but no powered craft. Large airships are powered by steam turbines.

In industry, the early 20th century is an age of standardized mass production. Calculated schemes of work requirements drive labor forces organized like small armies; efficiency experts do time and motion studies to increase the output from their human machines.

Medical science has fully exploited anesthesia and antisepsis. Its modern efforts focus on pharmaceuticals, both natural products and synthetics; synthetic chemists develop compounds that partially neutralize the toxicity of

arsenic, antimony, and other heavy atoms while retaining their usefulness against disease. Mortality from several forms of cancer has fallen significantly through chemical therapy. Battlefield medicine has also improved to the point where in a real war, more men might die of wounds than of disease.

### The Great Powers

Germany is the world's greatest nation and the model for a progressive society, with discipline as an essential tool of progress. The Germany army is better trained and equipped than any other. German universities train their students in advanced science; Germany industry applies it to precision machinery, fuel production, and synthetic chemistry.

In North America, the United States occupies a similar position and dominates the other American nations; political leaders have begun to talk about a Hemispheric Union, starting perhaps with the annexation of Panama. Japan has recently stepped forward in East Asia, notably through military victories over Russia and China.

The British Empire survives, but with less strength than formerly. The rising powers find it convenient to have the British fleet keep the seas open to shipping. More and more, though, Britain relies on other countries' industries, even their shipyards, to supply its armed forces. Americans and Germans say the British are too individualistic and organized on too small a scale for industrial efficiency.

The remaining European powers follow the German example, accept German leadership, or struggle against it – Sweden, Austria-Hungary, and France being examples, respectively. The Swedes successfully suppressed the Norwegian independence movement, partly through German methods of social control; Denmark remains independent by being a useful buffer state. The Finns remain securely under Russian control, despite Swedish aspirations.

### Analysis

Iron is the early 20th century with something subtracted: key advances in electrical technology, from the generator to radio. Internal combustion is less developed as well. Technology and society are closer to a 19th-century pattern. Most campaigns will be dystopian, emphasizing the high costs of heavy industry, though a heroic engineering theme is also possible. The mood should be grim. In a conspiratorial campaign, it may be useful to adopt a subtle weird science premise, making predictive social science a reality and a tool of corporate or international intrigue. Style may be either realistic or cinematic; the cinematic style is usually better for campaigns with a dystopian or conspiratorial emphasis.

### Adventure Seeds

*Dark Satanic Mills.* Not many Americans complain about wages; thanks to scientific management, most large firms can offer generous paychecks and benefits – and do, to prevent strikes. But that same management creates a different cause for unrest: excessive workloads, as workers wear themselves out to keep up a pace set by machines. Now the Wobblies (the Industrial Workers of the World) are planning a major strike in the steamcar works of Pittsburgh, while the Pinkertons are going to do their best to break it. Whichever side the player characters support, they will face violence, intrigue, and moral ambiguities.

### STEEL SOLDIERS

German industrial researchers have developed man-machine interfaces that allow a human operator to control anything from a waldo arm up to a full suit of powered armor. Naturally, these have military applications. Germany and Sweden both manufacture man-sized suits (see *Battlesuit*, p. 76), while Japan favors large walking vehicles with cockpit-style controls (see *O-Daisuchimu*, p. 77) and brought them into actual use in its recent takeover of Manchuria. The United States is working to develop its own models; the British buy theirs from Sweden, though they are also trying to purchase Japanese models for colonial use.

Soldiers in small battlesuits amount to improved infantry; they are only slightly slower than unarmored soldiers and can cross a fire zone with relatively low risk from small arms fire. German tactical doctrine calls for using them to break through enemy lines, with conventional infantry following. It will take between 10 and 25 years for such battle gear to become standard for infantrymen. The *o-daisuchimu*, by contrast, is a mobile artillery platform, with a visibility range of several miles that reduces dependence on forward observers and with the ability to maneuver over broken terrain.

### JOHN BAUER 150 POINTS

Age 35; 5'8"; 155 lbs.; conservatively dressed in good but slightly worn suits, with short blond hair.

ST 10 [0]; DX 11 [10]; IQ 13 [30]; HT 11 [10]  
Speed 5.75; Move 7.

Dodge 8; Parry 7.

**Advantages:** Ally Group [10]; Attractive [5]; Capital [5]; Charisma +1 [5]; Fearlessness +3 [6]; Status 1 [5].

**Disadvantages:** Fanaticism (Labor movement) [-15]; Reputation (Among the wealthy, lawyers, and law enforcement, union sympathizer, 10 or less, -2) [-3]; Secret (Revolutionary conspirator) [-10]; Struggling [-10].

**Quirks:** Competitive pistol shooter; Doesn't drink; Gives his own money to people in trouble; Quotes Latin sayings; Won't marry until the revolution succeeds. [-5]

*Continued on next page . . .*

## JOHN BAUER

(Continued)

**Skills:** Accounting-11 [1]; Acting-16 [8]; Administration-12 [1]; Area Knowledge (United States)-15 [4]; Bard-16 [6]; Body Language-12 [2]; Boxing-10 [1]; Cryptography-12 [2]; Detect Lies-12 [2]; Diplomacy-12 [2]; Disguise-12 [1]; Driving (Automobile)-12 [4]; Forgery-12 [2]; Guns-14 [1]; Guns Sport-16 [8]; History-13 [4]; Holdout-12 [1]; Intelligence Analysis-13 [4]; Law-16 [10]; Leadership-16 [6]; Philosophy (Historical materialism)-12 [2]; Research-14 [4]; Running-12 [8]; Savoir-faire-15 [0]; Shadowing-14 [4]; Shortsword-10 [1]; Strategy-12 [2]; Tactics-12 [2]; Writing-12 [1].

**Maneuvers:** Hit Location (Guns)-13 [2]; Jab (Boxing)-10 [4]; Off-Hand Weapon (Guns)-13 [4].

**Languages:** English (Native)-13 [0]; German-12 [1]; Latin-13 [2].

Early in his legal career, John Bauer agreed to take the case of two workmen facing criminal charges after a strike. Pressured to give up the case, he became stubborn, stuck it out, and lost by not quite managing to crack the perjured testimony of a factory guard. Ten years later, most of his business comes from labor unions and working people, though he has some income from an inheritance.

But he also wears another face: Under the pseudonym of Tribune, he is a leading figure in the underground American Socialist Party. He can afford to travel and can easily explain why he needs to do so, giving him a cover for his revolutionary career. Aided by four skilled and trusted allies, he has carried out a number of undercover operations and is one of the Party's leading spokesmen for direct action. He has made himself dangerous, knowing that the industrialists he opposes are equally dangerous.

## BEING QABALISTIC

With legal rights, wealth, and command of mystical forces, the Jews of Europe have gained renewed confidence in their traditions. Qabala has no assimilationist movements. Reformist schools within Judaism focus on enabling Jews to work effectively among gentiles, not to become *like* gentiles.

For Jews and Christians alike, a more commercial approach to life has become commonplace. The Netherlands could scarcely survive without merchant fleets bringing raw materials to golem-filled factories. Literacy, arithmetic, and accounting are widespread skills. But commerce is embedded in a religious framework: Qabala's industrial revolution has made society less, not more secular. Business meetings are commonly opened with prayers. When Christians and Jews are partners in a firm – not common, but far from unheard of – prayers are carefully worded to be acceptable to both, often borrowing Masonic formulas that refer to the Great Architect.



*Gambit.* Stationed on the Indian frontier, a small group of Russian agents carry on the Great Game against their British adversaries, hoping to bring Kashmir or Afghanistan under Russian control. But something strange is going on: the British are taking aggressive countermeasures against the Russians for actions that they never performed. Are they trying to contrive an excuse for war? Or is some third party taking a hand – and what will they gain from setting Britain and Russia at odds?

## QABALA

*François Montcorbier strolled down the streets of Paris, enjoying the tug of Anne-Marie's hand on his arm. Letting his mistress take him to visit a jeweler might be a costly diversion, but his surgical practice was going well; he could afford her whims. And a day outdoors, without the smell of blood in his nostrils, was a welcome relief.*

*Entering Levy's, François looked around casually, and found his attention drawn by a workbench at the back of the shop. He strolled closer and made sure of what he saw: on the bench two diminutive figures wielded tools proportionate to their size to shape a delicate bracelet, as the jeweler supervised. Tiny bronze hands moved with a precision humanly impossible, which even a trained surgeon could only envy...*

*He gestured, suddenly, to one of the store clerks, to ask for a word with the master.*

*A few minutes later, sitting down at the workbench to observe at close quarters, he asked, casually, "Of course I saw golems enough when I served in the army; no battlefield is free of them. But I cannot recall any so small, or doing such work. Is your establishment the first to have them?"*

*"Why, yes, I believe so, M. Montcorbier," answered Charles Levy. "My cousin Alfred made them for me, and he spent two weeks searching for precedents before deciding that it was legitimate to do so." He shrugged. "The law says that a golem may not replace a man, but must do a job that a man cannot do, because it exceeds his strength, or his endurance, or his ability to withstand harm . . ."*

*"Or, I see, the precision of his movements," François broke in.*

*"Just so, Monsieur."*

*François thought of the operation for stone he had performed the day before, probing clumsily in a man's opened bladder while three medical orderlies held his patient down. "I wonder," he said, "if your cousin might be willing to give me the honor of meeting him?"*



Qabala is a world going through an industrial revolution with a difference. All across Europe and here and there in other lands, thousands of golems labor in fields and workshops or fight on battlefields. Only rabbis of great knowledge and holiness can animate them, and the standing of Jews has greatly improved; people may not love them, but the nation that expels or abuses them cannot compete with countries that benefit from their secret arts. And with visible demonstrations of divine power in every city, many people are starting to wonder if Judaism may be the true faith after all.

The year of divergence is 1600. The critical event takes place in Prague, where Rabbi Judah Loew learns to animate unliving matter by inscribing holy words upon it. The campaign year is 1850.

## QABALA'S WORLD OF THE MIND

The spread of qabalistic enchantment through Europe has deeply affected its beliefs. It's abundantly clear that supernatural forces are real, no longer matters of legend, but as down-to-earth as the golem manning a pump or building fortifications on a battlefield. It's equally clear that Jews, rather than Christians, have access to those forces – despite the efforts of generations of "Christian qabalists." Christianity is still not over the shock of these revelations.

Some Christians explain golems as deceptions of Satan . . . but the Spanish, who embraced this belief, were defeated in battle by the French, who did not. Many Christians believe this is God's judgment on those who persecute His original chosen people. The economic revitalization of the Ottoman Empire, helped by the investments and magical arts of European Jews, has recommended traditional Muslim policies of tolerance to many Christian nations. Northern European nations extend legal protection to Jews, Catholics, and even Muslims.

The rabbinate has been occupied with working out laws to regulate the use of golems, starting from the three laws of Raibai (Rabbi Isaac Ben Judah). Jewish law emphasizes that golems are not to deprive men of their livelihood; they are to do jobs men cannot do, typically because they require too much strength or endurance or are too dangerous. In recent years a few rabbis have begun to consider a novel problem: what are Jewish congregations to do when Christians ask to convert? Rabbis are judges as well as priests and scholars, and most of them can tell when a Christian's real interest is simply the wealth that comes to makers of golems; but what are they to say to a Christian who sees divine power at work and wants to learn more of its ways?

### RABBINICAL ENCHANTMENT

Qabalistic enchantments are similar in many respects to standard *GURPS* magic; their effects can be based on the normal spell lists. But the way in which those effects are achieved is different. Rabbis know nothing of mana. Their spells are cast by divine power; no fatigue is suffered by casting them.

The basis for all qabalistic effects is the rule (p. C117) that one character point can be traded for 20 energy points of enchantments. A starting character can have up to 30 character points traded for magical energy points. These points can be invested in an actual enchanted object, typically but not necessarily a golem. A character need not be a qabalist to have a magical possession, but a non-Jewish character will need a significant Unusual Background! Alternatively, if the character is actually a qabalist, the energy points can be held in reserve for use during play. When they are used, the appropriate enchantment takes effect instantly.

*Continued on next page . . .*



## RABBINICAL ENCHANTMENT

(Continued)

A qabalist can gain additional power through prayer. Spending 200 hours gains 1 character point's worth of magical energy, or 20 energy points – 10 hours (one full day) equates to 1 energy point, equivalent to slow and sure enchantment. A qabalist can also gain power through study, at 1/2 the normal rate, or through leading a holy life of good conduct, at 1/4 the normal rate. Finally, a major mitzvah (meritorious act) is worth one character point (minor mitzvot are subsumed under "leading a good life").

Qabala is not a morally or religiously neutral technique that anyone can use. It is a Discipline of Faith, worth -10 points, based on adherence to Judaism. Qabalists gain no benefit from having assistants.

Qabala is a system of improvised magic, based on the Hebrew alphabet in a way comparable to Rune magic. The equivalent to Rune-Lore (see p. C1149 or pp. M80-83) is the skill of Gematria.

### GEMATRIA (MENTAL/VERY HARD)

DEFAULTS TO CRYPTANALYSIS-4  
OR OCCULTISM-5

PREREQUISITE: HEBREW-12+

Gematria assigns numerical values to the Hebrew letters and works out which words have the same or related numerical values. Each letter of the Hebrew alphabet is a separate skill, equivalent to one of the words used in improvised magic. Since there are only 23 letters, the noun Magic/Destiny is unavailable (the equivalent concept would be G-d, who is outside of human control), and the verbs Protect/Guard and Warn are combined. The resulting 10 verbs can be equated to the 10 sephiroth as well.

### GOLEMS

The creation of golems is the most spectacular application of qabala. The appropriate concepts are Create, Body/Man, and Earth. All the types of golem described on pp. M106-107 are available, with one exception: flesh golems would be blasphemous. Golems of other materials are possible as well – wood golems are an obvious example, ice golems an unlikely one, while marble, silver, or gold golems would be prohibitively expensive. Golems larger or smaller than human are possible. Energy cost for larger golems increases in proportion to their volume and weight: a bronze golem twice the size of a man has energy cost 1,200. Energy cost for smaller golems is 50% of that for full-sized golems, plus another 1% for each 2% of standard volume and weight. Thus, a bronze golem with 2% of normal human volume (standing about 18 inches tall) has energy cost 306. ST and HP are proportionate to volume, so the double-sized golem has ST 50 and 60 HP, while the 2% golem has ST 1 and 1 HP (rounded up from 0.5 and 0.6). DX, IQ, HT, Speed, PD, and DR are unaffected by size.

## History

The art of making golems spread only slowly at first; Rabbi Loew was reluctant to share his secret with anyone who might abuse it. But in the chaos of the Thirty Years' War, more and more Jewish communities needed protectors, and soon the secret was no longer a secret. The most intensely anti-Semitic Christians felt a superstitious dread of golems and backed away, while the rabbis tried very hard to ensure that their creations didn't inspire such intense fear as to bring out mob violence. A shtetl's golem was its insurance policy.

This limited role was first enlarged in the nations that extended legal toleration to Jews: the Netherlands and later England. Jews made up a large part of these countries' business owners; they could see the benefits of having a tireless, nearly indestructible worker who needed no wages. Protests by other Jews who saw their livelihoods threatened were resolved by rabbinic legislation, enforced by the threat of expulsion from the community: no one was permitted to use a golem to displace a man from his work. The proper work of golems was work too heavy, too prolonged, or too dangerous for a man to do. In 1687, for example, the rabbinate of the Netherlands provided golem-powered pumping stations, preserving both Jews and Christians from floods.

Less peaceful uses also developed in time. The manufacture of gunpowder was dangerous, causing explosions; why not have golems do the work? Ironworks which made cannon needed heavy labor; why not have golems provide it? Military engineering frequently involved construction under fire; why shouldn't golems take the risk? After decades of sporadic experiments, the Prussian monarchy made a systematic policy of using golems in its military infrastructure. The idea caught on elsewhere; many armies now have golems working for them, or sometimes fighting for them, controlled by Jewish warrant officers, civilian contractors, or mercenaries.

The result was a balance of power dominated by northern Europe, with the Netherlands in the lead. England remained secondary, as the Dutch preserved their command of the seas; Spain and Portugal, which considered golems diabolical, fell behind. A weakened Spain came under French domination and lost most of its colonies to other European powers. Prussia and Sweden became allies of the Dutch, while arrayed against them were the less rapidly industrializing Austria, England, France, and Russia.

During the 18th century, Prussia gained military and economic strength and began working toward German unification. The alarmed Dutch began seeking allies and providing them with economic and military aid. The War of the Germanies, 1756-1776, was fought mainly within the Holy Roman Empire, but nearly every European state took sides, and by its end the military use of golems was widespread. Nominal victory went to the Prussians, who gained control of several other German states. Since then, European powers have preferred to export their hostilities to colonial rivalries, primarily in the Americas and the Indian Ocean countries.

## Technology

For the basic capabilities of golems, see pp. M196-107. Golems are the basis for Qabala's heavy industry. Their presence has slowed the progress of conventional technology; when an iron golem (ST 30) can produce 0.6 kW 24 hours a day, without food or fuel, performing any motions that a human worker could perform and enduring conditions that no human worker could survive, mechanical engines are less desirable.

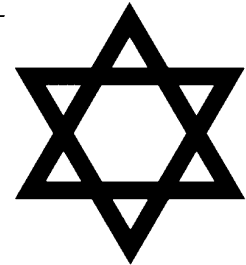

Continued on next page . . .

Because golems are available for industry and mining, the demand for human labor in these areas is relatively low; most men still work in agriculture. The large plantations of Brazil, the Caribbean, and Virginia and the Carolinas can usually afford golems, which has kept the slave trade relatively small. Recently a young rabbi, Karl Marx, proposed that an end to qabalistic secrecy and increased golem production could make possible the worldwide abolition of slavery; he is now living in Amsterdam, as the Prussians objected to overthrowing qabalism.

### **The Great Powers**

The Netherlands are the world's greatest power, by virtue of their economic vigor, their enormous fleet, and their omnipresent golems. Colonies in Nieuw Nederland and Pennswald, Brazil, Suidafrika, Ceylon, the East Indies, and Nieuw Zeeland provide trade goods, especially Brazilian coffee and the North American timber that builds the Dutch fleet. Overseas trade also goes to New England, Cherokee, and Japan.

Prussia is Europe's strongest land power, with a culture that emphasizes duty and the military virtues. The English historian Edward Gibbon called them Sparta to Holland's Athens. Prussian agents can be found in nearly every European capital, even (or especially) The Hague. The Prussian army appreciates good intelligence and has the rudiments of a military staff system; Jews are often recruited for such duties.

Following traditions that go back to Elizabeth I, England's Stuart monarchs have courted both sides in every conflict while being slow to form alliances. Currently, Elizabeth II's ministers are weighing offers of a secret alliance with Prussia, which would like to use England as a naval trump card against the Dutch.

Of the other European powers, the Ottoman Empire did very well out of the War of the Germanies through Prussian military and technical aid. France is allied with the Netherlands, despite popular protests against rich Jews and Huguenots displacing the old aristocracy. Other Dutch allies include Sweden, Poland, Bavaria, Austria, and the Papal States; other Prussian allies include Russia, Denmark, and Sicily.

In the Americas, the British hold Newfoundland, the French hold Canada, New England is independent, Dutch colonies stretch from the Hudson to the Chesapeake, the British hold Virginia and the Carolinas, the Cherokees are independent and rapidly modernizing, and Florida is still Spanish. France nominally holds most of interior and western North America but has not developed them, though a few French colonists in California have begun producing wines. French Mexique and Perou, Dutch Venezuela and Brazil, and British La Plata are sources of agricultural and mineral exports. The Dutch fleet is systematically wiping out piracy in the Caribbean.



## **RABBINICAL ENCHANTMENT**

(Continued)

### **HOW MANY GOLEMS?**

In 1850, the worldwide Jewish population numbers 12.5 million, including 8 million in Western Europe and 1 million in North America. About 1/60 of these are rabbis, or 150,000. Their prayers and studies accumulate 30 million energy per year. Roughly half goes into golem creation, divided among clay golems (12,000 a year), stone golems (7,500 a year), bronze golems (5,000 a year), iron golems (3,750 a year), and other golems (averaging 5,000 a year). Clay golems last 10 years, stone golems 20 years, metal golems 50 years, and other golems typically 20 years. The total stock of golems works out to just over 800,000. Their power output is 186,750 kw, equivalent to 5.6 million human workers when their ability to work round the clock is taken into account.

### **OTHER APPLICATIONS OF QABALA**

While qabalistic enchantment is theoretically unlimited – like the power it invokes! – certain uses are common, and rabbis are likely to know the appropriate letters. These include the following:

- Body Control (beneficial):  
Body/Man/Human, Strengthen/Repair
- Food: Food
- Healing: Heal
- Knowledge: Sense
- Light: Light
- Necromantic (summoning angels and spirits): Soul
- Protection and Warning: Protect/Guard, Warn

### **REBEKAH SCHWARTZBERG**

#### **100 POINTS**

Age 25; 5'4"; 120 lbs.; a blonde Jewish woman dressed in well made widows' clothing.

ST 9 [-10]; DX 10 [0]; IQ 12 [20]; HT 11 [10]  
Speed 5.25; Move 5.  
Dodge 5.

**Advantages:** Blessed (Special) [20]; Capital [5]; Cultural Adaptability [25]; Divine Favor (6 or less) [12]; Higher Purpose (Destroy the Inquisition) [5]; Status 1 [0]; Strong Will +2 [8]; Wealthy [20].

*Continued on next page . . .*

## REBEKAH SCHWARTZBERG

(Continued)

**Disadvantages:** Code of Honor (Merchant) [-5]; Secret (Anti-Inquisition activities) [-20]; Sense of Duty (Jews) [-10]; Social Stigma (Woman) [-5].

**Quirks:** Admires Old Testament heroines; Bargain hunter; Likes to read; Talks to her dead husband; Unsentimental. [-5]

**Skills:** Acting-13 [2]; Area Knowledge (Europe)-12 [1/2]; Area Knowledge (Vienna)-13 [1]; Black Powder Weapons (Pistol)-12 [1]; Cooking-13 [2]; Cryptanalysis-9 [1/2]; Cryptography-9 [1/2]; Diplomacy-12 [2]; First Aid-13 [2]; History-11 [2]; Intelligence Analysis-10 [1]; Intimidation-10 [1]; Leadership-11 [1/2]; Merchant-13 [2]; Needlecraft-8 [1/2]; Qabala-9 [1]; Savoir-Faire-15 [0]; Savoir-Faire: Military-12 [1/2]; Scrounging-12 [1]; Shadowing-12 [2]; Survival (Woodlands)-10 [1/2]; Survival (Urban)-11 [1]; Tactics-11 [1].

**Languages:** Yiddish (Native)-14 [0]; Dutch-13 [1]; French-12 [1/2]; German-12 [1]; Hebrew-13 [1]; Hungarian-12 [1/2]; Spanish-12 [1/2]; Turkish-12 [1/2].

Raised in a family of Jewish merchants in Vienna, Rebekah Eisenstein learned to deal with many languages and cultures by the time she reached adulthood. She married a young rabbi, Ari Schwartzberg, who was creating golems for a combat engineering team and traveled about Europe with him, until he accepted a French contract for service in Spain's latest civil war and fell afoul of the Inquisition. As soon as the war ended, Rebekah insisted on going to Spain and claiming his remains. Her experiences there led her to take an oath of vengeance against the Inquisition and to pray for divine aid. She received an extraordinary blessing, the power to create a stone golem, which she named Rache ("revenge"). Now she is preparing to return to Spain and begin her mission of destruction.

### BEING PROVIDENTIAL

Agents of Oculus Dei are recruited carefully. Essential qualifications include intelligence and self-command; prospective agents who lack a good education will receive one. Being a Catholic, or even a Christian, is optional, though agents are encouraged to convert and take priestly vows.

## Analysis

Qabala's most visible difference from Earth is the widespread presence of golems; most campaigns will focus on them. In effect, the usual campaign theme will be "scientific wonders," though the sciences are theology and gematria rather than physics and engineering. High adventure campaigns are also possible, or even heroic engineering campaigns, with rabbis bossing golem construction crews. Campaign moods will usually occupy the middle ground of drama. The best play style is realistic; qabalistic miracles will stand out better against a relatively matter-of-fact background.

For a variant treatment, use an inverted horror motif, in which the supernatural is relatively rational and civilized, while the dark aspects come from human cruelty and superstition, embodied for example in the Spanish Inquisition or mobs of Russian or Balkan peasants. Such a campaign may be cinematic.

## Adventure Seeds

*Klaatu Barada Nikto.* In a Russia where Jews are still targets of mass violence, Rabbi Nahum set up an insurance policy: A golem guardian instructed to destroy the Christian community if he was killed. Now a sudden heart attack has struck him down and his golem is on the rampage. The rabbi had a code phrase to deactivate his golem and subject it to a new master . . . but can the PCs decipher his records and get to the golem before it precipitates a civil war between Christians and Jews?

*Golems of the Caribbean.* While the English have too small a navy to challenge Dutch mastery of the seas, they continue to regard the Dutch as rivals. Imitating her namesake, England's Queen Elizabeth II has been commissioning privateers to sail the Caribbean. Now a Dutch naval crew has been sent out to suppress the privateers and the actual pirates who have imitated their example, sailing out of the notorious harbor of Port-Royal. Like all Dutch naval craft, this one has golems instructed to lead boarding parties and others to work its main guns. But the pirates have a few golems too – and would be glad to capture more if they can.

Things can get even more interesting if the Dutch ship puts in at the backward French colony Saint-Domingue. The island's colored slaves and ex-slaves have curious beliefs that cause strange reactions to golems. For a more exotic campaign, perhaps the houngans and bokors have their own access to the supernatural, with vevers instead of gematria.

## PROVIDENCE

*"It has become necessary to ask an extraordinary service of you."*

*Father Carlos's voice was even and measured, as if he were deriving a theorem in political economy. But Ramon Avila thought he detected a tension, if only in the stressed clarity of the Latin syllables. Had discipline permitted, he was sure he could have looked to either side and seen less controlled expressions on the faces of his fellow students, and even of the junior masters.*

*"Our calculations show that Bonapartist victory is inevitable in the current struggle. Spain will be governed by enemies of religion. Bonaparte may find outward compliance with the Church convenient, but he does not wish it to be independent of his will; he is the heir of those who seized our assets in France, which he has not restored.*



*"The Espinosa Bank has prepared secure storage for assets and business documents; we have helped fund this venture in return for vault space for our automata. Most of them will not be able to operate, but security will not be broken – and in these times we can serve better by collecting data than by analyzing them."*

*He spoke slightly louder, now, perhaps to be heard over the thudding of French artillery.*

*"The mechanisms must be transported inconspicuously. We ask you to carry them, a piece at a time. This must be done before the French enter the city, without drawing notice from those who might answer French questions. This is not part of your normal duties; but if you will undertake it, please step forth now."*

*Ramon could not see who else joined him, for he kept his eyes on Father Carlos, but he heard the steps of a roomful of his brothers in the order.*

### PROVIDENCE'S WORLD OF THE MIND

Oculus Dei is founded on two seemingly contradictory ideas: that an economy is so complex, with so many interdependencies, that only God can know the just price of any commodity or service, and that calculating engines and systematic data collection can overcome these limitations, making economic prediction and planning possible – they are "the eye of God." The order applies these ideas by seeking good investments in market economies and funding a political program aimed at free trade and security of property.

*Continued on next page . . .*

## PROVIDENCE'S WORLD OF THE MIND (Continued)

The School of Salamanca, from which the first idea derived, supported full human rights for indigenous people in Spanish and Portuguese colonies, opposing enslavement. They consider European colonialization inevitable and mostly desirable, but they try to encourage just and humane administration of colonies. *Oculus Dei* favors universal human rights; they were early supporters of the abolition of slavery.

They regard industrialization with ambivalence, and not simply because it is based on a technology they didn't pioneer. Mass production can create plenty, but also tends to subordinate the worker's human judgment to technical requirements; mass society and mass warfare trouble them deeply, as they tend to overwhelm any respect for the individual.

### NINE WORTHIES

A number of key figures played a role in the evolution of *Oculus Dei*'s strategies. Here are some important names:

*Ignatius Loyola*: The founder of the Society of Jesus.

*Matteo Ricci*: One of the first Jesuit missionaries to China, he became fluent in Chinese and gained admiration for Confucianism. His letter explaining what the Society of Jesus could learn from the mandarinates inspired the founding of *Oculus Dei*.

*Gottfried Wilhelm Leibnitz*: Primarily a philosopher, he invented calculus at the same time as Sir Isaac Newton, resulting in bitter disputes over priority. He developed sophisticated calculating engines and plans for general purpose computers, but concealed them at the request of *Oculus Dei*.

*Corrado Santangeli*: The founder of *Oculus Dei*.

*Luis de Molina*: The School of Salamanca's leading economic theorist.

*Francisco da Vitoria*: A member of the School of Salamanca, author of a treatise defending the rights of pagan peoples.

*Blaise Pascal*: More devout and less mathematically gifted than Leibnitz, he developed probability theory in response to a question from a gambler friend. Like Leibnitz, he worked with calculating engines and then suppressed them when asked to do so.

*Charles de Montesquieu*: Influenced by the School of Salamanca, he developed a concept of free institutions that influenced the writers of the Constitution of the United States.

*Rugjer Boscovich*: A Croatian Jesuit and a noted mathematician. He secretly worked for *Oculus Dei*, creating methods to compress the memory and time requirements of algorithms.

Providence is our world – or is it? Under the surface, it has an unfamiliar history. A secretive branch of the Society of Jesus, inspired by forgotten Spanish economic theories and by the example of Confucian intellectuals in China, has steered the world toward a *novus ordo* forecast by their calculating machines.

The year of divergence is 1605. The critical event is a letter by the Jesuit Matteo Ricci (see pp. WWii52-53) sketching the application of Confucian ideals to public administration. The campaign year is the referee's choice – in the past for a historical campaign, in the present for an investigation of secret histories.

### History

Three factors came together to produce the secret history of Providence: the economic theories of Spanish Jesuits; the inspiration of China's *ru* ("Confucians"); and the mathematical genius of Leibnitz. Ricci's letter, privately circulated among high-ranking Jesuits, started them thinking about the role of the *ru* in Chinese society. At the same time, theologians in Spain exploring the medieval concept of *just price* concluded that so many different factors worked to determine it that only divine omniscience could grasp them all; the best human recourse was to let the market decide. The conflicting implications of these two ideas generated a nice dilemma for the order's greatest minds: should they guide society through superior knowledge or keep their hands off?

Jesuit accounts of China came to the attention of Leibnitz in 1675. Among them was a discussion of the hexagrams of the *I Ching*, used for divination. Leibnitz saw in them the idea of binary arithmetic – which led him to mathematical logic and to a clockwork machine that could apply it. He mentioned this device to a Jesuit friend, Father Corrado Santangeli, whose imagination it captured.

Leibnitz's logical automaton, Santangeli pointed out to others within the order, could vastly increase the speed with which information was collected and analyzed. The order could actually *know* enough to apply such ideas as just price. In the short run, too, they could predict the operations of the market and gain working capital.

His ideas led to the foundation of the secret *Oculus Dei* ("Eye of God"), advised by Leibnitz, who agreed to keep his calculating engines secret.

History since then has been shaped by *Oculus Dei*. The Enlightenment was their work, as was the growth of international trade. They discouraged governmental support for the analytical engines of Charles Babbage – their monopoly was not broken until World War II.

### Technology

With the support of the order, the construction of logical automata reached heights Leibnitz never dreamed of. Powered by springs or counterweights, men turning cranks, or millwork, these devices performed computations that would strain the greatest human mind. The main limitation on their use was that each needed to be handcrafted, a labor-intensive task in a world without precision machining. The first attempts to calculate the social impact

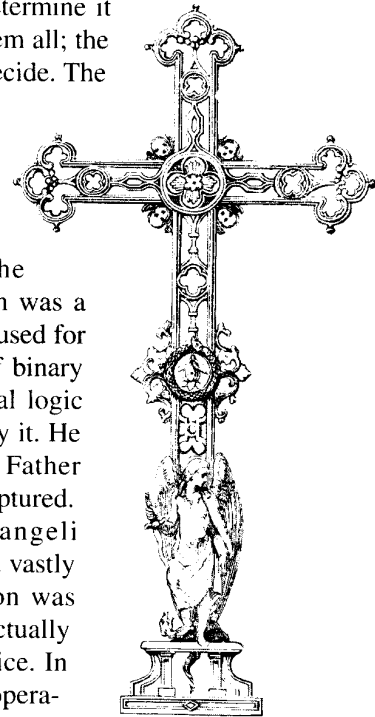

of standardized manufactures were fed into Oculus Dei's automata only after Babbage's proposals reached their attention.

As a sideline, experiments in mechanical life have been undertaken: metallic spiders that crawl about a room, or statues that play the flute. These mechanisms are blind and usually deaf, which limits their sophistication; they usually carry out fixed sequences of movements, though the most advanced have some error correction.

### *The Great Powers*

The great powers are those in our history books: Britain, Austria-Hungary, Russia, the Ottoman Empire, France, and Prussia. Behind the scenes, though, is another great power, lacking territory and diplomatic recognition, but able to impose its will in other ways: Oculus Dei.

As an organization, Oculus Dei could be described as a large corporation or as a very small nation. The principal site of the order is in Rome. A second major site is in Madrid; other European sites are in Lisbon, Vienna, Paris, and Dublin. Overseas branches operate in Macao, Manila, Goa, and Mexico City. These 10 houses gather political and economic data and engage in commercial operations, making them self-funding. Intelligence is supplied to the Catholic hierarchy on a "need to know" basis.

Oculus Dei's ties to the Catholic Church are strong. It remains a branch of the Society of Jesus, and its highest officers are Jesuits. But the order maintains the ecumenical approach pioneered by Jesuit missions in China, which accepted Confucianism as a source of ethical truths.

### *Analysis*

Providence is designed for illuminated campaigns, in which the theme is movement from ignorance to knowledge. Oculus Dei can be treated as the key divergence creating an alternative 19th (or 18th or 20th) century – a secret alternative history that a careful researcher might uncover; or, because it is secret, it can appear as a source of marvelous inventions and elaborate plots in a campaign set in the real 19th century. As secret conspiracies go, it's relatively benign, promoting human equality and liberal Catholicism, though the referee has the option of a more dystopian treatment.

For a wildly variant campaign, Oculus Dei can be used with *GURPS In Nomine*, under the sponsorship of Jean, Archangel of Lightning, or one of his servitors.

### *Adventure Seeds*

*Diplomacy.* The year is 1828. The British Parliament is discussing a Catholic Emancipation Act that would not merely protect Catholics from criminal penalties, but grant them full citizenship in the United Kingdom. Oculus Dei supports this act, both as a Catholic organization and on the basis of natural justice. A group of brothers have been sent to London to gather information on the proposal, project its success or failure, and identify ways to help it along.

*Industrial Archeology.* The year is 2000. At the bottom of the Caribbean, divers explore a recently discovered ship, identifying it as the *San Ignacio*, lost in 1795. One of the holds contains something unexpected: complex mechanisms with innumerable gears and mechanical linkages. The archeologist leading the project has invited a historian of technology to see what he can make of them. But the authorities are becoming uncooperative, and the university is considering withdrawing funding from the project, for no clear reason.

## FATHER CARLOS JAVIER, S.J.

### 225 POINTS

Age 43; 5'7"; 145 lbs.; a Spaniard, wearing priestly vestments, with hair starting to gray.

**ST** 9 [-10]; **DX** 10 [0]; **IQ** 15 [60]; **HT** 11 [10]  
Speed 5.25; Move 5.  
Dodge 5.

**Advantages:** Administrative Rank 6 [30]; Charisma +1 [5]; Clerical Investment 3 [15]; Comfortable [10]; Composed [5]; Manual Dexterity +1 [3]; Mathematical Ability [10]; Musical Ability +2 [2]; Patron (Oculus Dei, 12 or less) [50]; Patron (Society of Jesus, 9 or less) [15]; Status 1 [0].

**Disadvantages:** Cannot Harm Innocents [-10]; Discipline of Faith (Jesuit) [-10]; Secret (Oculus Dei) [-10]; Sense of Duty (Oculus Dei, the Society of Jesus: and the Roman Catholic Church) [-10].

**Quirks:** Admirer of Handel; Advocates Latin American independence; Humble; Makes musical automata; Mistrusts Bonapartists. [-5]

**Skills:** Acting-14 [1]; Administration -16 [4]; Appreciate Beauty (Music)-11/19 [1]; Area Knowledge (Spain)-15 [1]; Artist-14 [1]; Astronomy-14 [2]; Bard-15 [1]; Calligraphy-10 [1]; Computer Programming-14 [2]; Cryptography-13 [1]; Detect Lies-13 [1]; Diplomacy-17 [8]; Economics-15 [2]; Engineer (Clockworks)-15 [1]; History-14 [1]; Holdout-14 [1]; Intelligence Analysis-15 [4]; Jeweler-14 [1]; Law (Canon Law)-12/18 [1]; Mathematics-16 [1]; Mechanic (Clockworks)-16 [2]; Musical Composition-15 [1]; Musical Instrument (Flute)-16 [1]; Musical Instrument (Glass Harmonica)-16 [1]; Musical Instrument (Harpichord)-17 [2]; Musical Notation -17 [1]; Performance/ritual (Catholic)-14 [1]; Philosophy (Thomistic)-13 [1]; Physics-13 [1]; Politics-16 [4]; Research -15 [2]; Savoir-Faire-17 [0]; Teaching-16 [4]; Theology-14 [2]; Writing-14 [1].

**Languages:** English-14 [1]; Greek-14 [1]; Latin-15 [2]; Spanish (Native)-16 [1].

The second son of an aristocratic Spanish family, Carlos Javier received a good education in preparation for the priesthood. A favorite teacher recruited him first for the Society of Jesus and later for Oculus Dei, recognizing his brilliant intellect and mathematical gifts. He began as an artificer and still spends his rare free time building automata, usually elaborate music boxes. Asked to consult on financial concerns of Oculus Dei, he showed a talent for negotiation that brought him promotions and a new vocation. Now he is the head of the Madrid house of the order and deeply concerned about preserving its secrets against Napoleon's armies and spies. He can imagine only too well what a tool his order would make in Bonapartist hands.



# GLOSSARY

These terms were current in the real 19th century, except for the two indicated by an asterisk, which have a modern coinage. They can add a great deal of flavor to either a historical or a steampunk campaign.



**Aeronef:** An aircraft that has a stall speed; that is, a heavier-than-air craft.

**Aerostat:** An aircraft that has a zero stall speed; that is, a lighter-than-air craft such as a balloon or airship.

**Analytical engine:** A proposed design for a general-purpose computing engine working purely mechanically, with steam power, gears, and punched-card programming.

\***Anthropomorphization:** Giving an animal's body a humanoid form.

**Antimacassar:** A doily pinned to the back of a chair to protect the fabric from the macassar oil that many men wore on their hair.

**Apergy:** A hypothetical repulsive gravitational force.

**Apoplexy:** A stroke.

**Atavism:** A state of evolutionary regression to a less advanced form of life.

**Barrister:** A lawyer who is licensed to present cases in court. See *solicitor*.

**Bartitsu:** A school of ju-jitsu developed by E.W. Barton-Wright and taught in London.

**Batman:** A soldier assigned to act as a personal servant to an officer.

**Bertillonage:** A technique for criminal identification based on exact measurement of 11 parts of the body.

**Billingsgate:** Crude and abusive language, named after a district of London where fish were sold and such language was common in the streets.

**Bitters:** Alcohol flavored with substances such as orange peel or wormwood.

**Bloody:** Often claimed to be a contraction of "by Our Lady." Most Victorians didn't know the etymology but they knew it was extremely bad language.

**Bourgeoisie:** People whose income derives from investments or land rather than from working.

**Boxing Day:** December 26, a day when small gifts of money were made to servants and the needy.

**Brevet:** In effect, a temporary promotion to the next highest military rank, granting command authority but no increase in pay.

**Brougham:** A moderately priced carriage that many middle-class families could afford, with a closed body and two or four wheels, and usually drawn by one horse; pronounced "broom" or "brome." Especially favored by physicians.

**Chapel:** Often used to refer to a place of worship used by Dissenters; contrasts with "church."

**Chemist:** A seller of drugs and related products.

**Claïrvoyance:** Extra-sensory perception.

**College:** In British usage, one of the subdivisions of Cambridge or Oxford, with its own grounds where students and some instructors resided, dined, socialized, and sometimes studied. Each college provided tutors for its undergraduates.

**Commanding officer:** In the 19th century, an officer other than a ship's captain or master who is temporarily in command; the phrase never means the captain, who is simply the captain.

**Condenser:** (1) Part of a steam engine where steam is turned back into liquid water than can be reused, reducing the need to take on new water regularly. (2) The 19th-century name for what is now called a capacitor.

**Consols:** Government bonds paying 3% interest, from the consolidated funds they were used to raise.

**Consumption:** An advanced stage of pulmonary tuberculosis, usually leading to death fairly quickly.

**Corn:** In British usage, any grain, but especially wheat. The American product is called "Indian corn" or "maize."

**Corset:** An undergarment used to compress a woman's waist, theoretically to a fashionable 18 inches, though many women left theirs partly unfastened most of the time. A favorite target of health-conscious dress reformers.

**Cut direct:** Pointedly not seeing a person with whom one does not wish to speak.

**Dementia praecox:** Schizophrenia, so called to distinguish it from dementia senilis.

**Demimondaine:** A woman with a questionable reputation who retains traces of respectability.

**Difference engine:** The precursor to the analytical engine, a mechanical computer designed to calculate and typeset mathematical tables.

**Dirigible:** Any lighter-than-air craft with engines for powered flight, but normally used for a craft with a nonrigid gasbag.

**Dissenter:** In England and Wales, a member of a Protestant church not part of the Anglican hierarchy; for example, a Methodist. Dissenters were seen as lower-class, puritanical, and often politically radical.

**Dollymop:** A streetwalker.

**Dreadnought:** An extremely large and heavily armored steel battleship.

**Élan Vital:** A "vital force" that was believed to pervade living matter.

**Ether, luminiferous:** A hypothetical invisible and intangible substance filling all of space that carries light waves and other electromagnetic waves.

**Eugenics:** Proposals to breed human beings scientifically, to enhance desirable characteristics or eliminate undesirable ones.

**Fenian:** A member of an Irish organization devoted to freeing Ireland of British rule through illegal methods, sometimes including murder and terrorism.

**First floor:** In Britain, the floor above the ground floor.

**Heliograph:** A device for sending messages across country in Morse code, using mirrors to reflect sunlight.

**Ironclad:** A warship with iron armor — on early ironclads, mostly above the waterline to protect against other ships' guns.

**Jack Ketch:** The hangman.

**Laudanum:** A solution of opium in alcohol; widely sold in the 19th century.

**Love that dares not speak its name, the:** Male homosexuality.

**Lucifer:** A match that could be struck on any rough surface; first manufactured in 1830.

**Magnetism (or animal magnetism):** Hypnotism; also called mesmerism after Anton Mesmer.

**Making love:** Courting or wooing. When a man "makes love" to a woman, he is declaring his affections and trying to persuade her to return them, as his wife or less formally; he is not expressing himself physically.

**Marquess of Queensberry:** A set of rules for boxing as a sport, adopted at the end of the 19th century. Also, the man who lent his good name to those rules.

**Mews:** A building devoted to horses, riding gear, and carriages.

**Mind over matter:** Psychokinesis.

**Miss —:** The oldest daughter of the family, indicated by her first name not being used in talking about her.

**N-rays:** A new form of radiation reported by René Blondlot in 1903 and later shown not to exist.

**Natural philosophy:** Physics.

**Omnibus:** A large horse-drawn vehicle carrying 20 or more passengers; the name, meaning "for everyone" in Latin, was quickly shortened to "bus."

**Parole:** A soldier's promise not to engage in further hostilities or attempt to escape after being captured.

**Pecker:** Courage, as in "keep your pecker up" to someone facing danger.

**Peerage:** The actual aristocracy, as opposed to the gentry; barons, viscounts, earls, marquises, and dukes.

**Plum pudding:** A Christmas pudding made from raisins.

**Political economy:** Economics.

**Post-captain:** A naval officer in command of a ship who actually holds the rank of captain.

**Phrenology:** A proposed science of human character based on assigning functions to sections of the brain and measuring their relative sizes.

**Psychical research:** The scientific study of psionic powers and the afterlife.

**Rates:** Local taxes, paid primarily to support aid to the poor.

**Resurrectionist:** A merchant dealing in illegally procured corpses for use at medical schools.

\***Sapientization:** Giving an animal's brain human-equivalent cognitive functions.

**Sent down:** Expelled from Oxford or Cambridge for serious misconduct; Mary Shelley's husband Percy was sent down for publishing *The Necessity of Atheism*, for example.

**Solicitor:** A lawyer who was not authorized to plead in court. Solicitors handled many routine legal functions directly; in addition, barristers were hired (and paid) by solicitors, not directly by their clients.

**Subaltern:** An army officer ranking below captain.

**Telodynamics:** A system of power transmission using wire ropes stretched between large pulleys, effective over several miles.

**Thought transference:** Telepathy.

**Transportation:** The practice of punishing criminals by sending them to remote colonies, usually in Australia.

**Tripos:** The examination taken at Cambridge to qualify for honors in mathematics; from the three-legged stool that candidates sat on at one time.

**White slavery:** The recruitment of women, especially young women, into prostitution by coercive methods ranging from threats to drugs to fraudulent job offers. A major concern for Victorian social reformers.

**Wireless:** Radio; shortened from "wireless telegraphy" (and later "wireless telephony").

**Wog:** Often glossed as "worthy Oriental gentleman," but actually carries a tone of contempt. Can refer to any Asian. Really xenophobic British characters sometimes say "wogs begin at Calais" (that is, as soon as you cross the English Channel).

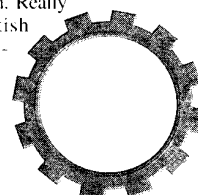

# BIBLIOGRAPHY

## FACTUAL INFORMATION

- Braverman, Harry. *Labor and Monopoly Capital* (Monthly Review Press, 1974). An unorthodox Marxist view of how the organization of work changed in the late 19th and early 20th centuries.
- George, James L. *History of Warships* (Naval Institute Press, 1998). The Age of Steam is only a small part of this book, but is covered lucidly, with excellent discussions both of ship design and of naval tactics.
- Hugill, Peter J. *World Trade since 1431* (Johns Hopkins University Press, 1993). Includes extensive coverage of the growth of 19th century technology and its economic impact, with rich quantitative information.
- Lowell, Percival. *Mars* (Houghton Mifflin, 1895). The source for the science fiction of Edgar Rice Burroughs and H.G. Wells, available online at <http://www.bibliomania.com/NonFiction/Lowell/Mars/> — including Lowell's maps of the Martian canals.
- Pool, Daniel. *What Jane Austen Ate and Charles Dickens Knew* (Simon & Schuster, 1993). A guide to British life and customs in the 19th century.
- Severa, Joan L., Rexford, Nancy, and Kidwell, Claudia Brush. *Dressed for the Photographer* (Kent State University Press, 1997). Annotated photographs of Americans from the 19th and early 20th centuries.
- Standage, Tom. *The Victorian Internet* (Walker and Company, 1998). A history of telegraphy emphasizing the parallels to recent information technology.
- Turner, Gerard L.E. *Scientific Instruments, 1500-1900: An Introduction* (University of California Press, 1998). A beautifully illustrated volume of scientific instruments up through the end of the Victorian Era.
- Williams, Stephen. *Fantastic Archeology* (University of Pennsylvania Press, 1991). Written as a critique of fringe archaeology, this volume will have other uses for the game master.
- Winter, Alison. *Mesmerized: Powers of Mind in Victorian Britain* (University of Chicago Press, 1998). A cultural history of one of the borderlands of Victorian science.

## FICTION OF THE PERIOD

- Burroughs, Edgar Rice. *A Princess of Mars*. The best-known fictional treatment of Lowell's Mars.
- Doyle, Arthur Conan. *The Adventures of Sherlock Holmes and Memoirs of Sherlock Holmes*. Holmes is a perfect embodiment of Victorian rationality.
- Doyle, Arthur Conan. *The Lost World*. The classic story of surviving dinosaurs. Doyle's character Professor Challenger personifies the Science! skill.
- Kipling, Rudyard. *The Day's Work*. Some of Kipling's best short stories, including engineering fiction.
- Kipling, Rudyard. "McAndrew's Hymn." Many people have heard shortened versions of this poem as song lyrics. The complete poem is worth reading; it helped create the Scottish engineer as a literary archetype.
- Kipling, Rudyard. "With the Night Mail" and "As Easy as A.B.C." Two stories set in a very unusual future history where global commerce depends on vividly imagined airships.
- Shelley, Mary. *Frankenstein*. The first novel about an artificial being, and still worth reading.
- Verne, Jules. *A Journey to the Center of the Earth*. If possible, read the translation by William Butcher (Oxford University Press, 1992).
- Verne, Jules. *From the Earth to the Moon*. The translation by Walter James Miller (Gramercy, 1978) has all of Verne's text, including the political and cultural satire and the engineering details.
- Verne, Jules. *Twenty Thousand Leagues under the Sea*. Walter James Miller collaborated with Frederick Paul Walter on a version of this book (United States Naval Institute, 1993) that also outstrips its predecessors.
- Wells, H.G. *The Time Machine*. The time machine is only a vehicle; the real story is the dark future Wells envisions. Victorian industrialization worked out to an appalling conclusion.

- Wells, H.G. *The Invisible Man*. Wells's protagonist is a prototype for many later supervillains.
- Wells, H.G. *The Island of Dr. Moreau*. The original "making men from animals" story.
- Wells, H.G. *The First Men in the Moon*. The early parts explore the implications of a gravity screen; the later parts describe an alien extraterrestrial landscape.
- Wells, H.G. *The War of the Worlds*. This novel shows how remote space travel seemed to the Victorians — and presents a version of Lowell's Mars far grimmer than Edgar Rice Burroughs'. Indiana University Press published the Critical Edition in 1993.

## RECENT FICTION

- Bear, Greg. *Dinosaur Summer* (Aspect, 1998). A sequel to *The Lost World* set in the 1950s.
- Davidson, Avram. *The Adventures of Dr. Exterhazy* (Owlswick Press, 1990). Whimsical fantasy set in a late-19th-century Balkan empire.
- Flynn, Michael. *In the Country of the Blind* (Baen, 1990). Steampunk with a twist: our own present day culture is the product of secret societies using Babbage engines for their own purposes.
- Franson, Robert W. *The Shadow of the Ship* (Del Rey, 1983). Wagon trains travel between the stars in a bizarre hyperspace; the alternative technology is ingenious and the setting evokes the American 19th century without copying it too literally.
- Fraser, George MacDonald. *Flashman* (New American Library, 1986). This historical novel and its many sequels offer a hilarious satire on Victorian ideals through the private memoirs of Sir Harry Flashman, decorated hero (and cowardly scoundrel).
- Garrett, Randall. *Murder and Magic, Lord Darcy Investigates, and Too Many Magicians* (Ace, 1979, 1981, and Doubleday, 1967). Two short story collections and a novel that combine Victorian-flavored culture and technology with effective ritual magic. The detective story aspects are entertaining and well presented.
- Gibson, William, and Sterling, Bruce. *The Difference Engine* (Bantam, 1991). The technological vision and the alternative history are stronger than the actual story.
- Gray, Alasdair. *Poor Things* (Harcourt Brace Jovanovich, 1992). An ingenious twist on the Frankenstein theme.
- Heinlein, Robert. *The Number of the Beast* (Fawcett Columbine, 1980). Embedded in this book is a quintessentially steampunk British colony on Mars.
- Jeter, K.W. *Morlock Night* (DAW, 1979). A horror sequel to H.G. Wells' *The Time Machine*.
- Pratchett, Terry. *The Fifth Elephant* (HarperCollins, 2000). This recent Discworld fantasy includes several steampunk elements: rapid communications via semaphore and heliograph, economies based on mineral resources, and archaic feudal realms coming into contact with progressive urbanized countries.
- Priest, Christopher. *The Prestige* (Touchstone, 1995). Rival Victorian stage magicians involve Nikola Tesla in their contest.
- Pullman, Philip. *The Golden Compass and The Subtle Knife* (Del Rey, 1999). These young adult novels combine steam age technology, advanced physics, and theological fantasy in an ingenious alternate history setting.
- Roberts, Keith. *Pavane* (Acc, 1968). Early steam technology in an alternative England conquered centuries earlier by the Spanish Armada.
- Stirling, S. M. *Marching through Georgia, Under the Yoke, and The Stone Dogs* (Baen, 1988, 1989, 1990). A trilogy of alternative history novels set in a twentieth century where technology followed a more steampunk-like path to the stars.
- Swanwick, Michael. *Jack Faust* (1997). The industrial revolution begins 300 years early thanks to knowledge granted to Faust by Mephistopheles.

## GAMES

- Barton, William A. *Cthulhu by Gaslight* (Chaosium, 1986). A sourcebook for Lovecraftian adventure in Victorian England.

- Bridges, Bill. *Sons of Ether Tradition Book* (White Wolf, 1993). Steampunk as magic: A mystical interpretation of the ether and of Victorian-inspired weird science in one of the best supplements for *Mage: The Ascension*.
- Chadwick, Frank. *Space 1889* (Game Designers' Workshop, 1988). First-rate worldbuilding made this game of Victorian space travel a cult favorite despite awkward game mechanics.
- Cook, David "Zeb," Sargent, Carl E., and Boomgarden, Karen S. *For Faerie, Queen, & Country: Amazing Engine Universe Book* (TSR, 1993). This book is useful for GMs interested in running GURPS Steampunk campaigns with a fantasy edge.
- Pondsmith, Mike. *Castle Falkenstein* (R. Talsorian Games, 1994). A fantasy game set in an alternative Victorian era with a number of steampunk elements. The supplement *Steam Age* (R. Talsorian Games, 1994) makes these elements more explicit and offers concepts for numerous inventions. See also the *GURPS* adaptation.
- Rowland, Marcus L. *Forgotten Futures* (Heliograph, 2000). A series of campaign settings based directly on pre-World War I science fiction, one of which adapts Kipling's "With the Night Mail" and "As Easy as A.B.C." Now in print after years of online distribution; the more complete online version is still available at [www.forgottenfutures.com](http://www.forgottenfutures.com).

## COMICS

- Augustyn, Brian. *Gotham By Gaslight* and *Master of the Future* (DC, 1991 and 1992). A Victorian Batman vs. Jack the Ripper and an analog of Robur the Conqueror, respectively.
- Messner-Loeb, William. *Brave Old World* (Vertigo, 2000). Stories of a small group of involuntary time travelers from 2000 to 1900.
- Moore, Alan. *League of Extraordinary Gentlemen* (America's Best Comics, 1999-2000). Alan Moore assembles a team of proto-superheroes of the late Victorian Era.

## FILMS AND TV

- Laputa: Castle in the Sky* (Hayao Miyazaki, 1986). In a world of steam engines, airships, and primitive radio, a floating city become the focus of power struggles as seen by two children. Animated.
- Metropolis* (Fritz Lang, 1926). One of the classic silent films, this vision of an oppressive hyperindustrial society of the future is still compelling.
- Nadia: Secret of Blue Water* (Hideaki Anno, 1990). Two Victorian children are drawn into a struggle between Captain Nemo and the scientist-priests of a new Atlantis. Animated.
- The 1900 House* (PBS, 2000). A documentary about a contemporary British family who volunteer to live with Victorian customs and technology. Invaluable for getting the feel of everyday life in the past.
- Photographing Fairies* (Nicholas Willing, 1997). Set after the end of the period, but captures the late Victorian coexistence of science and occultism. Arthur Conan Doyle makes an appearance.
- Robot Carnival* (Kazufumi Nomura, 1987). Two episodes in this anthology are steampunk: "Gears of Franken" retells the story of Frankenstein and his monster, and "A Tale of Two Robots, Chapter 3" shows a battle between 19th-century Japanese and American mecha. Animated.
- Sakura Wars* (Sega Enterprises, 1997-1998). A fantasy of warfare between demons and human beings with superhuman powers, set in an alternative 1920s Tokyo with advanced steam technology. Animated.
- Time after Time* (Nicholas Meyer, 1979). This American film could be called "reverse steampunk": H. G. Wells pursues Jack the Ripper into 1970s San Francisco. The portrait of Wells is romanticized — the real man was neither so attractive nor so naive — but the premise is ingenious and the resulting plot is often cleverly worked out.
- The Wild Wild West*. The gadgets in the movie are steampunk, but it's the original television show (1965-1969) that's a classic, setting marvelous inventions and undercover adventure in the Old West.

# INDEX

- Addiction disadvantage, 45.
- Adultery, 29.
- Advantages, 44-45.
- Aerial dreadnought, 81.
- Aesthete template, 31.
- Africa, 120-121.
- Age of Sail, 56-57.
- Age of Steam, 15-29, 58; *alternative*, 11; *economics of*, 48-50; *exploration in*, 17-18; *gender relations in*, 27; *government in*, 24; *industry in*, 15-17; *jobs in*, 48-50; *organizations of*, 21-22; *politics in*, 12-13, 23-25; *religion in*, 27-28; *science of*, 15; *sexuality in*, 29; *society in*, 12-13, 26-27; *travel in*, 110-123; *warfare in*, 18-21.
- Air vehicles, 80-83.
- Analytical Engines, 85-86; *table*, 85.
- Antigravity, 99-100.
- Apothecaries, 65.
- Architecture skill, 47.
- Area Knowledge skill, 46.
- Armoury skill, 47.
- Army or Navy Officer template, 32.
- Artificial Intelligence skill, 47.
- Artillery, 56; *table*, 88.
- Asiatic kingdoms, 117-120.
- Astral Travel, 105.
- Astronef, 83.
- Automata, 85-88; *table*, 85.
- Babbage, Charles, 6.
- Balkans, 117-118.
- Barnum, Phineas T., 8.
- Barton, Clara, 8.
- Batteries, 71; *table*, 71.
- Battlesuit, 76.
- Beam Weapons skill, 47.
- Bertillon, Alphonse, 62.
- Bertillonage, 62.
- Bicycle, 73.
- Bismarck, Otto von, 8.
- Black Powder Weapons skill, 46.
- Blavatsky, Helena Petrovna, 8.
- Bly, Nellie, 8.
- Boers, 121.
- Boiler explosions, 70.
- Bombs, rockets, and torpedoes table, 89.
- Boxing, 54.
- British Empire, 111-114.
- Brunel, Isambard Kingdom, 8.
- Burton, Richard, 8.
- Byron, Lord George Gordon, 8.
- Byron, Ada, 7.
- Campaigns, *building*, 125-126; *cross-genre*, 125-127; *settings*, 126-141; *style*, 6-8, 12-13.
- Captain Nemo, 51.
- Captain of Industry template, 32-33.
- Cargo Dirigible, 81.
- Cavalry, 56.
- Character templates, 31-42; *Aesthete*, 31; *Army Officer*, 32; *Captain of Industry*, 32-33; *Clergyman*, 33; *Creation*, 33-34; *Demimondaine*, 34; *Detective*, 34-35; *Engineer*, 35; *Explorer*, 35-36; *Inventor*, 36-37; *Medium*, 37-38; *Navive Leader*, 38; *Navy Officer*, 32; *Reckoner*, 38-39; *Reformer*, 39; *Reporter*, 39-40; *Scientist*, 40-41; *Servant*, 41; *Sportsman*, 42.
- Characters, 30-51, *from history and fiction*, 50-51.
- Chemical substances, 93.
- China, 119.
- Class, *social*, 26-27.
- Clergyman template, 33.
- Clipper Ship, 78.
- Clockwork, 69.
- Clockwork Armor, 76.
- Code of Honor disadvantage, 45.
- Colt, Samuel, 8.
- Combat, *aerial*, 55; *naval*, 56-60.
- Communications, 57.
- Complexity, 85.
- Computer Operation skill, 46.
- Computer Programming skill, 46, 47.
- Cope, Edward Drinker, 9.
- Cost of living table, 49.
- Creation template, 33-34.
- Criminal investigation, 61-62.
- Criminology skill, 47.
- Cryptography, 61.
- Currency, 48-49.
- Darwin, Charles, 9.
- Delusion disadvantage, 45, 54.
- Demimondaine template, 34.
- Detective template, 34-35.
- Dueling, 53.
- Difference engine, 86.
- Disadvantages, 45-46.
- Driving skill, 46, 47.
- Drugs, 64; *TL5*, 91-92; *TL(5+1)*, 92-93.
- Earth's core, 122.
- Economics, 48-50.
- Ectoplasm, 104.
- Edison, Thomas, 9.
- Élan vital, 98-99.
- Electric aeronef, 83.
- Electric astronef, 83.
- Electronics skill, 46.
- Electronics Operation skill, 46.
- Energy weapons table, *heavy*, 89; *portable*, 89.
- Engineer template, 35.
- Epidemiology skill, 48.
- Equipment, 90-91.
- Ericsson, John, 9.
- Espionage, 60-61.
- Etheria, 126-131.
- Etheric devices, *and the spirit world*, 105-106.
- Etheric Science skill, 48.
- Etheric Shock, 97-98; *beam weapons*, 98; *bombs*, 98; *table*, 98.
- Eugenics, 104.
- Europe, 116-117.
- Evolution, *alternate theories of*, 100-103.
- Exploration, 17-18.
- Explorer template, 35-36.
- Faraday, Michael, 9, 95.
- Field intelligence, 58.
- Fingerprinting, 62.
- Fire control, 59-60.
- Fire discipline, 55.
- Forward Observer skill, 46, 59-60.
- France, 116.
- Free trade, 111-112.
- Gadgeteer advantage, 68.
- Gender relations, 27.
- General staff, 58.
- Genetics skill, 46, 47.
- Genteel Proficiency Delusion, *see Delusion disadvantage*.
- Geography, 17-18.
- Geology, 25.
- Germany, 117.
- Ghosts, 104-105.
- Glider, *prototype*, 82.
- Golden Nightingale, 86.
- Golems, 134-138.
- Gravitic balloons, 99-100.
- Gravity screens, 99-100, *table*, 99.
- Great Game, *The*, 60-61.
- Gunner salvo table, 59.
- Gunner skill, 46.
- Gunnery, 59-60.
- Guns skill, 46.
- GURPS Robots**, 86.
- GURPS Vehicles**, 72.
- GURPS Warriors**, 32.
- Hand weapon table, 88.
- Hertz, Heinrich, 7.
- H.M.S. *Devastation*, 58, 79.
- H.M.S. *Dreadnought*, 59, 79-80.
- Independent Income advantage, 44.
- Industry, 15-17.
- Infantry formations, 56.
- Infantrymen, 54-55.
- Invention advantage, 44, 68.
- Inventor template, 36-37.
- Ireland, 113.
- Iron, 130-134.
- Iron horse, 75.
- Japan, 10, 119-120.
- Jeweler skill, 48.
- Jobs, 48-50; *table*, 50.
- Judaism, 134-138.
- Jupiter, 123.
- Kipling, Rudyard, 10.
- Krupp, Alfred, 10.
- Land ironclad, 55, 74-75.
- Land vehicles, 73-77.
- Latin America, 115.
- Launchers table, 89.
- Lecherousness disadvantage, 45.
- Leopold II, King of Belgium, 121.
- Linguistics skill, 46.
- Logistics, *rail*, 56.
- London, 113-114.
- Lost cities, 122.
- Luminiferous ether, 95-98.
- Lunar shell, 83.
- Machine Empathy advantage, 45.
- Magic, 107-108; *faury tale*, 107; *incorporating in a campaign*, 12-13; *industrial*, 108; *rabbinical*, 135-137; *Victorian Ritual*, 107.
- Magnetism, 104.
- Making men, *from animals*, 100-101; *from chemicals*, 103; *from corpses*, 102.
- Mars, 122-123.
- Marsh, Othniel Charles, 9.
- Martial arts, 53.
- Martians, 131.
- Marx, Karl, 10.
- Mathematics skill, 48.
- Mauzy, Matthew Fontaine, 10.
- Maxwell, James Clerk, 7, 10, 95.
- Mechanic skill, 48.
- Mechanical brain, 86.
- Mechanical men, *table*, 87; *also see automata*.
- Medicine, 63-66; *and mortality rates*, 65-66.
- Medium template, 37-38.
- Mediums, 104-105.
- Mercury, 121.
- Metallurgy skill, 48.
- Mill, John Stuart, 10.
- Missionaries, 120.
- Mormons, 117.
- Motors table, 72.
- Multimillionaire advantage, 44.
- Mysterious rays, 95.
- Native Leader template, 38.
- Navigation skill, 48.
- Negative mass, 100.
- New elements, 95.
- Nightingale, Florence, 10, 65.
- Nobel, Alfred, 11.
- Nuclear Physics skill, 46.
- Nursing, 65.
- O-Daisuchiimu, 77.
- Observation balloon, 81.
- Opium War, 119.
- Organization, *military*, 55; *naval*, 59-60.
- Organizations, 21-22.
- Ornithopter, 82.
- Ottoman Empire, 117-118.
- Panama Canal, 111.
- Parole, 54; *also see Vow disadvantage*.
- Pasteur, Louis, 11.
- Patron advantage, 44.
- Photography skill, 46.
- Phrenology skill, 48, 107.
- Physician skill, 48.
- Physicians, 63.
- Piloting skill, 46, 48.
- Pinkerton, Allan, 11.
- Pinkerton and Company, 61, 62, 132.
- Planets, 97, 121-123.
- Player piano, 86.
- Politics, 12-13, 23-25.
- Poor, *the*, 26.
- Power, *requirements table*, 72; *transmission*, 71-72; *transmission systems table*, 71; *water*, 69; *wind*, 69.
- Prices, 48-49.
- Price list, 49.
- Primitive man, 25.
- Prostitution, 28.
- Providence, 138-141.
- Psionics skill, 46.
- Psychic archaeology, 106-107.
- Psychic powers, 103.
- Psychical research, 103-107.
- Punishment, 62-63.
- Qabala, 134-138.
- Ranged weapons table, 88.
- Rank, 43; *military*, 55; *naval*, 59-60.
- Reactionless drives, 96-97.
- Reckoner template, 38-39.
- Religion, 27-28.
- Reformer template, 39.
- Reporter template, 39-40.
- Rhodes, Cecil, 11.
- Rote Learning disadvantage, 45.
- Russia, 116.
- Saturn, 123.
- Savoir-Faire skill, 47.
- Science, 15; *vs. religious thought*, 27-28; *weird*, 8.
- Scientist template, 40-41.
- Sense of Duty disadvantage, 45.
- Servant template, 41.
- Shipbuilding skill, 48.
- Shiphandling skill, 47.
- Skills, 46-48; *TL5*, 46-47; *TL(5+1)*, 47-48.
- Sky city, 82.
- Skyscrapers, 68-69.
- Slavery, *abolishing*, 113-114, 115.
- Smoking, 28.
- Social position, 43.
- Social Science, *predictive*, 106-107.
- Social status and cost of living table, 49.
- Social Stigma disadvantage, 43.
- Society, 12-13, 26-27.
- Soft drinks, 28.
- Solar steamer, 84.
- South Seas, 120.
- Space vehicles, 83-84.
- Spectral globe, 106.
- Sportsman template, 42.
- Status, 43.
- Steam carriage, 74.
- Steam calliope, 86.
- Steam engines, 69-71; *solar*, 70; *table*, 70; *upgrades*, 70.
- Steam junk, 78.
- Steam locomotive, 74, *load calculation*, 110.
- Steam mole, 75.
- Steam power beyond rated maximum table, 70.
- Steampunk, 6, 12, 15; *campaigns*, 124-141.
- Strong Will advantage, 44.
- Submarine, *advanced*, 80.
- Sunken continents, 97.
- Surgeons, 63-65.
- Surgery, 64-65.
- Surgery skill, 47.
- Teamster skill, 47.
- Tech levels, 9, 13.
- Technology, 68-72; *alternative*, 6-8; *and magic*, 12-13.
- Telegraph, 61.
- Telegraphy skill, 47.
- Templates, *see character templates*.
- Tesla, Nikola, 11.
- Time machine, 84.
- Time vehicles, 83-84.
- Timeline, 1815-1914, 15-24.
- TL(5+1), 9, 13.
- Toxic effects, 63.
- Transcendentalism, 108.
- Travel, 110-123.
- Turbinia, 79.
- United States of America, 10, 114-115.
- Vehicles, 72-84; *air*, 80-83; *land*, 73-77; *simple designs*, 73; *space*, 83-84; *stats key*, 73; *time*, 83-84; *water*, 78-80.
- Venerians, 129-130.
- Venus, 121-122.
- Vow disadvantage, 45.
- Vulcan, 123.
- Walker, William, 11.
- Wartare, 18-21, 53-60; *aerial*, 21, 55; *colonial*, 56; *land*, 18-19; *mechanized*, 55; *naval*, 19-20, 56-60.
- Washington, Booker T., 11.
- Water vehicles, 78-80.
- Water wheel table, 69.
- Weapons, 87-89; *tables*, 88-89.
- Wells, H.G., 12.
- Wild West, 116-117.
- Wireless telegraphy, 96, *table*, 96.
- Women, *and sexuality*, 29; *as adventurers*, 43.
- Zionism, 119.